



We offer you Country Exclusivity for any product's from PDF catalog.

What you need to do, is to order samples with the net price. On selected product, we will publish information about public price and your data, so clients will contact you directly.

You keep this exclusivity for the product as long as you buy something, every month.

We are practically selling our products for you with your price.

[Contact us](#)

Ceramic tiles catalog - price list

Katalog der Keramikfliesen

Catalogue de carreaux en céramique

Catálogo de baldosas cerámicas



PAVIGRES21 HELLO BEM-VINDO

sede:
APARTADO 42 | EC ANADIA
3781-909 ANADIA - PORTUGAL
TEL: +351 231 510 600 • FAX: +351 231 504 143
EXPORT@PAVIGRES.COM
MERCADO EXTERNO . EXTERNAL MARKET . MARCHÉ EXTÉRIEUR . AUSSENMARKT
COMERCIAL@PAVIGRES.COM
MERCADO INTERNO . INTERNAL MARKET . MARCHÉ INTERNE . INNENMARKT

GPS: N 40 25.333 W 8 26.052
Z.I. ALMAS DAS DOMINGAS • 3780-244 ANADIA

delegação:
LISBOA
EMPREENHIMENTO PORTUCALLE - LOTE 4.42.01
PÁTIO DAS PIROGAS - LOJA 33 - BL. C3 - PISO 0 • 1990-616 LISBOA
TEL: +351 218 960 110/1 • FAX: +351 218 960 112
DELEGACAO.LISBOA@PAVIGRES.COM

GPS: N 38 46.616 W 9 05.711

INDEX

004 NOTAS EXPLICATIVAS E SIMBOLOGIA
EXPLANATION NOTES AND SYMBOLS
NOTAS EXPLICATIVAS Y SIMBOLOGÍA
NOTES EXPLICATIVES ET SYMBOLES
ERKLÄRUNGEN UND SYMBOLS

008 TABELA SINÓPTICA
SYNOPTIC TABLE
TABLA SINÓPTICA
TABLE SYNOPTIC
ÜBERSICHT

010 FORMATOS E MODULARIDADE
SIZES AND MODULARITY
FORMATOS Y MODULARIDAD
FORMATS ET MODULARITÉ
FORMATE UND MODULARITÄT

012 890x890mm

018 597x1190mm

022 447x890mm

028 597x597mm

044 297x597 mm

050 197x597 mm

060 447x447 mm

070 297x297 mm

108 97x297 mm

124 197x197 mm

140 147x147 mm

146 97x97 mm

156 ACABAMENTOS ESPECIAIS
SPECIAL FINISHING
ACABAMIENTOS ESPECIALES
FINITIONS PARTICULIÈRES
SPEZIELLE OBERFLÄCHEN

158 TACTILE
297x297mm

162 ESTRUTURADO
STRUTURED
ESTRUCTURADO
STRUCTURÉ
STRUKTURIERT

168 ANTIDERRAPANTE
ANTI-SLIP
ANTIDERRAPANTE
ANTI-DÉRAPANT
TRITTSICHER

176 U4 P4+

178 U4 P4S

180 INFORMAÇÃO TÉCNICA
TECHNICAL INFORMATION
INFORMACIÓN TÉCNICA
INFORMATION TECHNIQUE
TECHNISCHE INFORMATION

200 PROJECTOS
PROJECTS
PROYECTOS
PROJETS
OBJEKTE

PT

As bases têm uma referência composta por duas letras que variam conforme o tipo de produto (PC, PP e PG) e um código numérico.

GB

The field tiles have a reference designation with two letters that change according to the type of product (PC, PP and PG) and a number code.

ES

Las baldosas tienen una referencia compuesta por dos letras que varían conforme el tipo de producto (PC, PP o PG) y un código numérico

FR

Les carreaux ont une référence composée par 2 lettres selon le type de produit (PC, PP et PG) et un code numérique

DE

Die Artikelnummer besteht aus 2 Buchstaben (PC, PP und PG) und eine referenznummer



PC Revestimento UNICOLOR Brillante
UNI Glossy Wall Tile
Revestimiento UNICOLOR Brillante
Faïence UNI Brillante
Glänzende Steingut Wandfliesen Uni



PP Grés Vidrado
Glazed Vitrified Tiles
Grés Vidriado
Grès Émaillé
Glasiertes Steinzeug



PG Grés Porcelânico Técnico
Homogeneous Technical Porcelain Tiles
Grés Porcelânico Técnico
Grès Cérame Technique
Technik unglasiertes Feinsteinzeug

As peças especiais ou diferentes acabamentos implicam a adição de uma letra representativa. (verificar tabela na pág. seguinte)

For special tiles or different finishing a representative letter is added. (check board on the next page)

Las piezas especiales o diferentes acabados implican adicionar de una letra representativa, cuyo significado listamos en el cuadro siguiente.

Pour les pièces particulières ou de finition spéciale une lettre représentative est ajoutée.

Für Formteile und Sonderstücke wird ein zusätzlicher Buchstabe beigefügt.

UNI

Referente a Cores Lisas (Unicolor)
(Unicolor) Referring to Uni Colours
Referente a cores lisas (Unicolor)
Correspondant aux teintes unies
Uni

FINO

Referente a Granitos Finos
Referring to Fine Speckles
Referente a Granitos Finos
Correspondant aux porphyres
Feinkorn



PP
mate . mat . matt

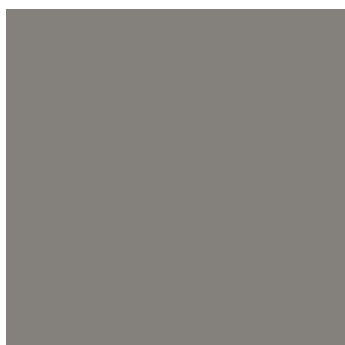

PG uni
// mate . mat . matt
// macio . honed . adoucie . weich

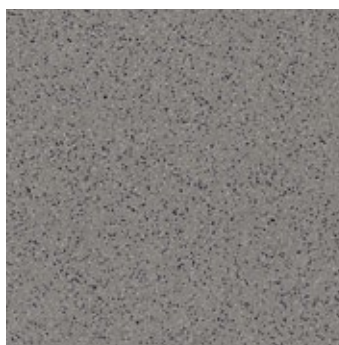

PG fino
// mate . mat . matt



PC
brilho . glossy . brillo . brilliant . glänzend

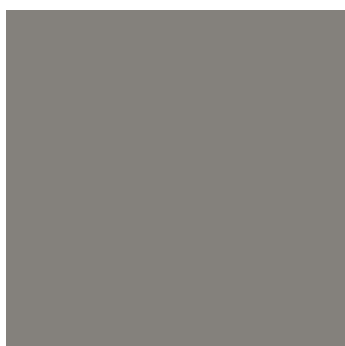

PG uni
polido . polished . pulido . poli . poliert

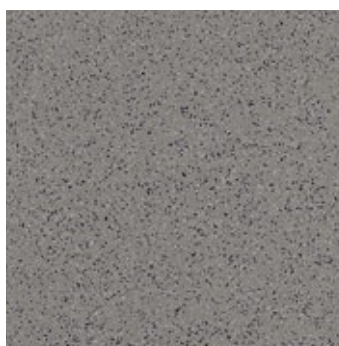

PG fino
polido . polished . pulido . poli . poliert

PT
Formatos disponíveis em cada tipo de produto (mm):

EN
Available sizes for each type of product (mm):

ES
Formatos disponibles en cada tipo de producto (mm):

FR
Formats disponibles dans chaque type de produit (mm):

DE
Erhältliche Formate für die verschiedenen Typen der Produkte (mm):

PC 297x597x11.9 • 197x597x11.6 • 97x297x8.3 • 197x197x7 • 147x147x6.5

PP 297x297x7.2 • 97x297x7.2 • 197x197x6.0 • 147x147x6.0 • 97x97x6.0

PG 890x890x10.5 • 597x1190x10.5 • 447x890x10.5 • 597x597x10.5 • 297x597x9.2 • 447x447x9.2 • 297x297x8.3 • 97x297x8.3 • 197x197x8.3 • 147x147x8.3 • 97x97x8.3

Cores disponíveis por formato: (verificar tabela sinóptica ou de referências)







































Available colours per size: (check synoptic or references board)

Colores disponibles por formato: (mire tabla de referencias)







































Coloris disponibles par format. (vérifier le tableau de synthèse ou le tableau des références)

Für die erhältlichen Farben der jeweiligen Formate, prüfen Sie bitte die Artikelnummern oder die Synoptic

NOTAS EXPLICATIVAS . EXPLANATION NOTES // SIMBOLOGIA . SYMBOLS

		PT	EN
mm		Tipo de produto disponível	Type of product available
		Revestimento (paredes)	Wall tiles
		Pavimento / Revestimento	Floor / Wall Tiles
		Pavimento	Floor Tiles
PC		Briho	Glossy
PP		Mate	Matt
PG		Mate	Matt
PG	RT	Mate Rectificado	Matt Rectified
PG	 8,3	Pastilha Porcelânico Mate	Porcelain Mosaic Matt
PG	P 	Polido (sempre rectificado)	Polished (always rectified)
PG	M 	Macio (sempre rectificado)	Honed (always rectified)
PGS	EN 	Estruturado R11C (versão 3) . sem cristalina	Structured R11C (version 3) . without crystalline
PG	E  8,3	Estruturado R11C (versão 1)	Structured R11C (version 1)
PG	EB  8,3	Estruturado R11B (versão 2)	Structured R11B (version 2) . without crystalline
PP	X  8,3	Antiderrapante espessura normal R11B	Anti-slip normal thickness R11B
PG	X  8,3	Antiderrapante espessura normal R12C	Anti-slip normal thickness R12C
PG	Y  12	Antiderrapante forte espessura R12C	Anti-slip extra thickness R12C
PG	YR  12	Antiderrapante forte espessura R13	Anti-slip extra thickness R13
PG	U  14	Antiderrapante forte espessura R12C	Anti-slip extra thickness R12C
PG	Z  12	Acabamento mate forte espessura P4S	Matt extra thickness P4S
PG	V  14	Acabamento mate forte espessura P4S	Matt extra thickness P4S
PG	K  11	Acabamento mate espessura intermédia P4+	Matt medium thickness P4+
PG	B  97x297	Rodapé prensado direito (mate)	Pressed skirting Board (matt)
PG	F  97x297	Rodapé prensado curvo (mate)	Pressed Cove Base Sit-On (matt)
PP	G  97x197	Rodapé prensado curvo (mate)	Pressed Cove Base Sit-In (matt)
PG	G  97x197 97x297	Rodapé prensado curvo (mate)	Pressed Cove Base Sit-In (matt)
PG	H  95x297	Rodapé cortado (mate)	Skirting board rounded edge (matt cut)
	HP  95x297	Rodapé cortado (polido)	Skirting board rounded edge (polished cut)
	HM  95x297	Rodapé cortado (macio)	Skirting board rounded edge (honed cut)
PG	L  95x447	Rodapé cortado (mate)	Skirting board rounded edge (matt cut)
	LP  95x447	Rodapé cortado (polido)	Skirting board rounded edge (polished cut)
	LM  95x447	Rodapé cortado (macio)	Skirting board rounded edge (honed cut)
PG	W  95x597	Rodapé cortado (mate)	Skirting board rounded edge (matt cut)
	WP  95x597	Rodapé cortado (polido)	Skirting board rounded edge (polished cut)
	WM  95x597	Rodapé cortado (macio)	Skirting board rounded edge (honed cut)
PG	FI  25x97	Ângulo interno para rodapé curvo 97x297	Internal angle for cove base 97x297
PG	FE  25x97	Ângulo externo para rodapé curvo 97x297	External angle for cove base 97x297
PG / PP	GI  25x97	Ângulo interno para rodapé curvo 97x197	Internal angle for cove base 97x197
PG / PP	GE  25x97	Ângulo externo para rodapé curvo 97x197	External angle for cove base 97x197
PP / PC	JI  25x197	Meia cana interna	Internal cove
PP / PC	JE  25x197	Meia cana externa	External cove
PG	D 95x297	Degrau (mate)	Step tread (matt)
	DP 95x297	Degrau (polido)	Step tread (polished)
	DM 95x297	Degrau (macio)	Step tread (honed)
PC	T 25x97	Listelos	Borders
PCD		Decoração em revestimento - PC	Decoration in wall tiles - PC
PGD		Decoração em Grés Porcelânico Técnico - PG	Decoration in Homogeneous Technical Porcelain Tiles - PG

NOTAS EXPLICATIVAS . NOTES EXPLICATIVES . ERKLÄRUNGEN // SIMBOLOGÍA . SYMBOLES . SYMBOLS

		ES	FR	DE
mm		Tipo de producto disponible	Type de produit disponible	Erhältliche Produkte
		Revestimiento (paredes)	Revêtement de murs	Wandfliesen
		Pavimento / Revestimiento	Revêtement de sols / Revêtement de murs	Bodenfliesen / Wandfliesen
		Pavimento	Revêtement de sols	Bodenfliesen
PC		Brillante	Brillante	Glänzende
PP		Mate	Mat	Matt
PG		Mate	Mat	Matt
PG	RT	Mate Rectificado	Mat Rectifié	Matt Rektifiziert
PG	 <u>8,3</u>	Mosaico Porcelánico Mate	Mosaïc en Grés Cérame Mat	Unglasiertes Feinsteinzeug Mosaik Matt
PG	P 	Pulido (siempre rectificado)	Poli (toujours rectifié)	Poliert (immer rektifiziert)
PG	M 	Macio (siempre rectificado)	Adoucie (toujours rectifié)	Weich (immer rektifiziert)
PGS	EN 	Estructurado R11C (versión 3) . sin cristalino	Structuré R11C (version 3) . sans cristalline	Strukturiert R11C (Version 3) . ohne Kristallin
PG	E  <u>8,3</u>	Estructurado R11C (versión 1)	Structuré R11C (version 1)	Strukturiert R11C (Version 1)
PG	EB  <u>8,3</u>	Estructurado R11B (versión 2) . without crystalline	Structuré R11B (version 2) . without crystalline	Strukturiert R11B (Version 2) . without crystalline
PP	X  <u>8,3</u>	Antiderrapante espesor normal R11B	Antidérapante épaisseur normale R11B	Trittsicher normale Stärke R11B
PG	X  <u>8,3</u>	Antiderrapante espesor normal R12C	Antidérapante épaisseur normale R12C	Trittsicher normale Stärke R12C
PG	Y  <u>12</u>	Antiderrapante espesor fuerte R12C	Antidérapante forte épaisseur R12C	Trittsicher Überstärke R12C
PG	YR  <u>12</u>	Antiderrapante espesor fuerte R13	Antidérapante forte épaisseur R13	Trittsicher Überstärke R13
PG	U  <u>14</u>	Antiderrapante espesor fuerte R12C	Antidérapante forte épaisseur R12C	Trittsicher Überstärke R12C
PG	Z  <u>12</u>	Acabado mate fuerte espesor P4S	Finition mat forte épaisseur P4S	Matt Überstärke P4S
PG	V  <u>14</u>	Acabado mate fuerte espesor P4S	Finition mat forte épaisseur P4S	Matt Überstärke P4S
PG	K  <u>11</u>	Acabado mate espesor intermedio P4+	Finition mat épaisseur moyenne P4+	Matt Mittlere Stärke P4+
PG	B  97x297	Rodapié prensado recto (mate)	Plinthe à bord biseauté (mat)	Sockelleiste (matt)
PG	F  97x297	Rodapié prensado curvo (mate)	Plinthe à talon (mat)	Hohlkehlssockel (matt)
PP	G  97x197	Rodapié prensado curvo (mate)	Plinthe à gorge (mat)	Hohlkehlssockel (matt)
PG	G  97x197 97x297	Rodapié prensado curvo (mate)	Plinthe à gorge (mat)	Hohlkehlssockel (matt)
PG	H  95x297	Rodapié cortado (mate)	Plinthe avec bord arrondi (mat coupé)	Sockelleiste mit abgerundeter Kante geschnitten (matt)
	HP  95x297	Rodapié cortado (pulido)	Plinthe avec bord arrondi (poli coupé)	Sockelleiste mit abgerundeter Kante geschnitten (poliert)
	HM  95x297	Rodapié cortado (macio)	Plinthe avec bord arrondi (adoucie coupé)	Sockelleiste mit abgerundeter Kante geschnitten (weich)
PG	L  95x447	Rodapié cortado (mate)	Plinthe avec bord arrondi (mat coupé)	Sockelleiste mit abgerundeter Kante geschnitten (matt)
	LP  95x447	Rodapié cortado (pulido)	Plinthe avec bord arrondi (poli coupé)	Sockelleiste mit abgerundeter Kante geschnitten (poliert)
	LM  95x447	Rodapié cortado (macio)	Plinthe avec bord arrondi (adoucie coupé)	Sockelleiste mit abgerundeter Kante geschnitten (weich)
PG	W  95x597	Rodapié cortado (mate)	Plinthe avec bord arrondi (mat coupé)	Sockelleiste mit abgerundeter Kante geschnitten (matt)
	WP  95x597	Rodapié cortado (pulido)	Plinthe avec bord arrondi (poli coupé)	Sockelleiste mit abgerundeter Kante geschnitten (poliert)
	WM  95x597	Rodapié cortado (macio)	Plinthe avec bord arrondi (adoucie coupé)	Sockelleiste mit abgerundeter Kante geschnitten (weich)
PG	FI  25x97	Angulo interno para rodapié curvo 97x297	Angle intérieur pour plinthe à talon 97x297	Innenecken für Hohlkehlssockel 97x297
PG	FE  25x97	Angulo externo para rodapié curvo 97x297	Angle extérieur pour plinthe à talon 97x297	Aussenecken für Hohlkehlssockel 97x297
PG / PP	GI  25x97	Angulo interno para rodapié curvo 97x197	Angle intérieur pour plinthe à gorge 97x197	Innenecken für Hohlkehlssockel 97x197
PG / PP	GE  25x97	Angulo externo para rodapié curvo 97x197	Angle extérieur pour plinthe à gorge 97x197	Aussenecken für Hohlkehlssockel 97x197
PP/PC	JI  25x197	Media caña interna	Gorge intérieur	Innenrundung
PP / PC	JE  25x197	Media caña externa	Gorge extérieur	Aussenrundung
PG	D 25x197	Peldaño (mate)	Nez de marche (mat)	Stufenplatte (matt)
	DP 25x197	Peldaño (pulido)	Nez de marche (poli)	Stufenplatte (poliert)
	DM 25x197	Peldaño (macio)	Nez de marche (adoucie)	Stufenplatte (weich)
PC	T 25x197	Listelos	Listels	Bordüren
PCD		Decoración en revestimiento - PC	Décor sur faïence - PC	Dekor für Wand - PC
PGD		Decoración en Grés Porcelánico Técnico - PG	Décor en Grés Cérame Technique - PG	Dekor für Technik unglasiertes Feinsteinzeug - PG

- 👉 REVESTIMENTO UNICOLOR BRILHANTE . UNI GLOSSY WALL TILE
- 👉 REVESTIMIENTO UNICOLOR BRILLANTE . FAÏENCE UNI BRILLANTE . GLÄNZENDE STEINGUT WANDFLIESEN UNI

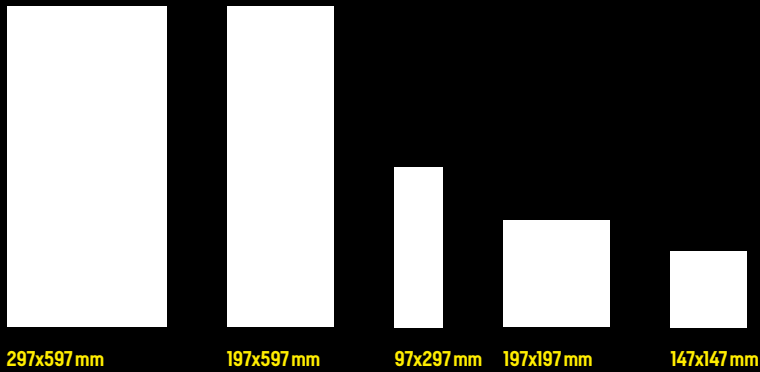

- 👉 GRÉS VIDRADO . GLAZED VITRIFIED TILES
- 👉 GRÉS VIDRIADO . GRÉS ÉMAILLÉ . GLASIERTES STEINZEUG

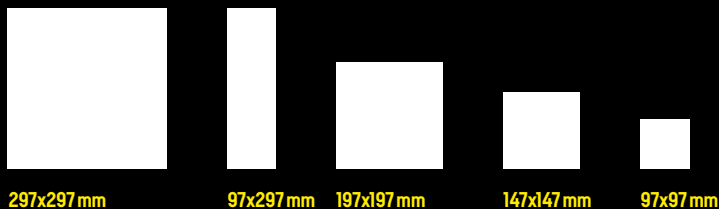

- 👉 GRÉS PORCELÂNICO TÉCNICO . HOMOGENEOUS TECHNICAL PORCELAIN TILES
- 👉 GRÉS PORCELÂNICO TÉCNICO . GRÉS CÉRAME TECHNIQUE . TECHNIK UNGLASIERTES FEINSTEINZEUG

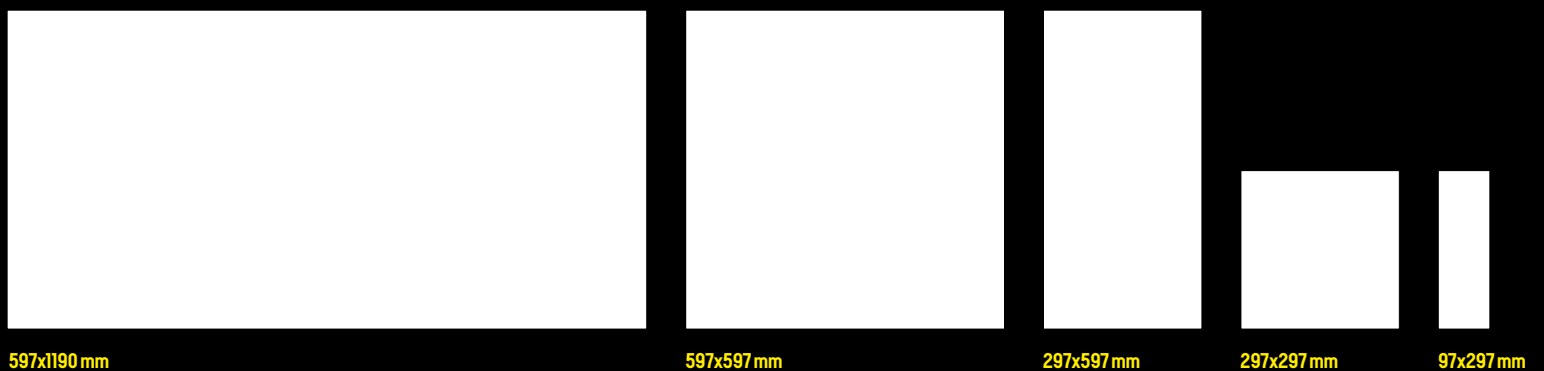
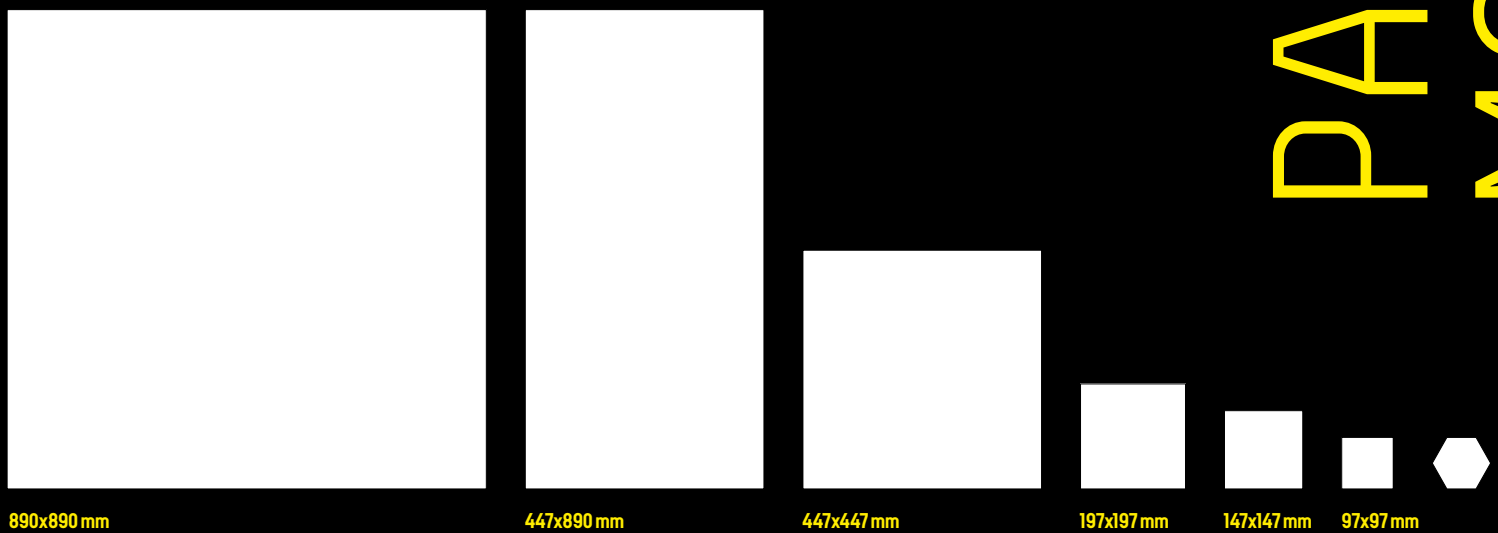

PAVIGRES21 MODULI ARIDAE

MODULARITY

junta . joint . joints . Fuge: 3 mm

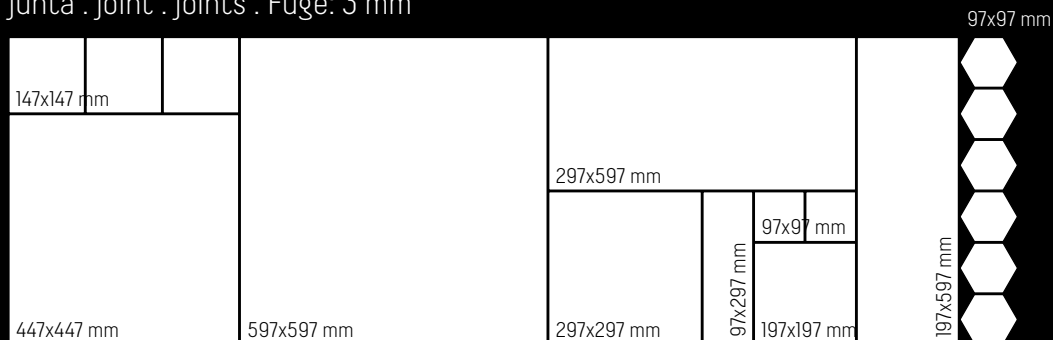

junta . joint . joints . Fuge: 2 mm

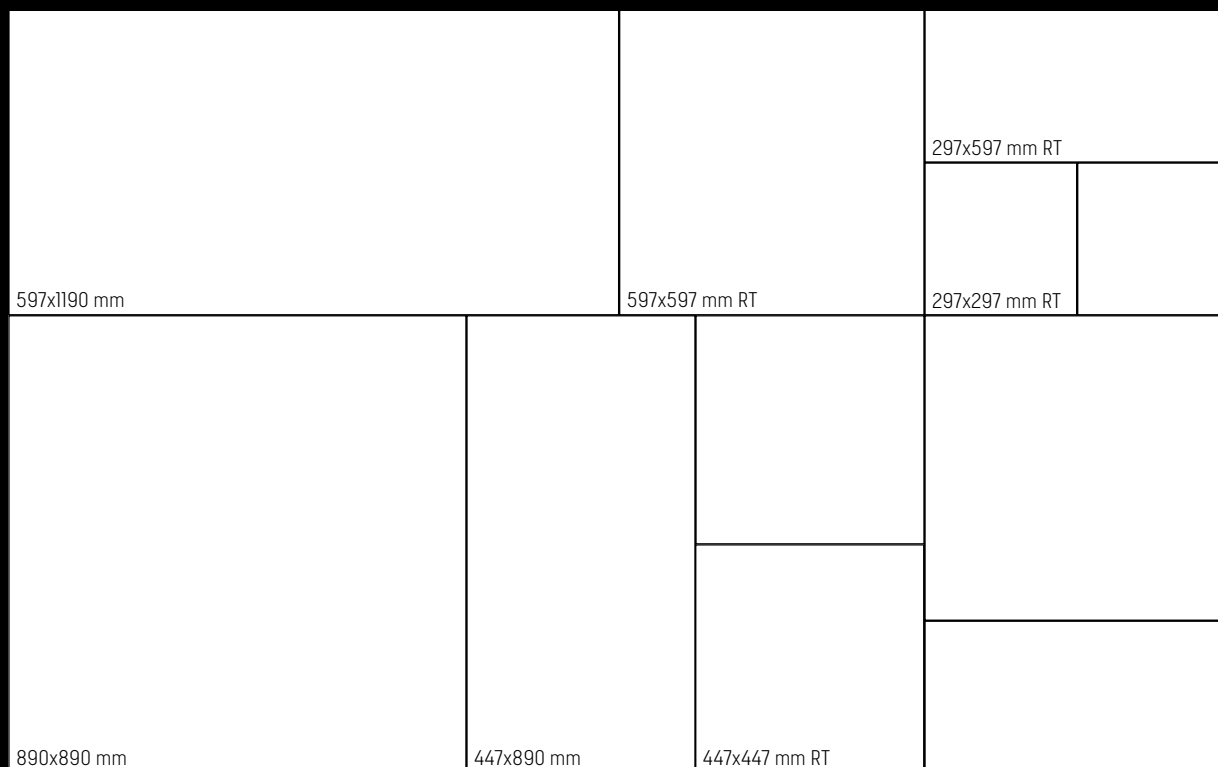

MODULARIDADE . MODULARITY . MODULARIDAD
MODULARITE . MODULARITAT

Formatos e Calibres	VER	
Formats and Sizes	SEE	
Formatos y Calibres	VER	PG. 197
Formats et Calibres	VOIR	
Formate und Kaliber	SIEHE REF.	

Espeçura	VER	
Thickness	SEE	
Espessor	VER	PG. 8
Épaisseur	VOIR	
Stärke	SIEHE REF.	

8990 >

890



PAVIMENTO / REVESTIMENTO
FLOOR / WALL TILES
PAVIMENTO / REVESTIMIENTO
REVÊTEMENT DE SOLS / DE MURS
BODENFLIESEN / WANDFLIESEN



MATE
MATT
MATE
MAT
MATT



POLIDO
POLISHED
PULIDO
POLI
POLIERT

GRÉS PORCELÁNICO TÉCNICO
HOMOGENEOUS TECHNICAL PORCELAIN TILES
GRÉS PORCELÁNICO TÉCNICO
GRÉS CÉRAME TECHNIQUE
TECHNIK UNGLASIERTES FEINSTEINZEUG

890x890mm

GRÉS PORCELÂNICO TÉCNICO . HOMOGENEOUS TECHNICAL PORCELAIN TILES

GRÉS PORCELÂNICO TÉCNICO . GRÉS CÉRAME TECHNIQUE . TECHNIK UNGLASIERTES FEINSTEINZEUG



PG506P . UNI GELO 890x890 mm
PG507RT . UNI METAL 890x890 mm
PG470P . UNI METAL 447x890 mm



10.5

890x890mm

GRÉS PORCELÂNICO TÉCNICO . HOMOGENEOUS TECHNICAL PORCELAIN TILES

GRÉS PORCELÂNICO TÉCNICO . GRÈS CÉRAME TECHNIQUE . TECHNIK UNGLASIERTES FEINSTEINZEUG



uni metal

PG 507RT • mate . mat . matt • R9A • 10,5 mm

PG 507P • polido . polished . pulido . poli . poliert • 9,8 mm

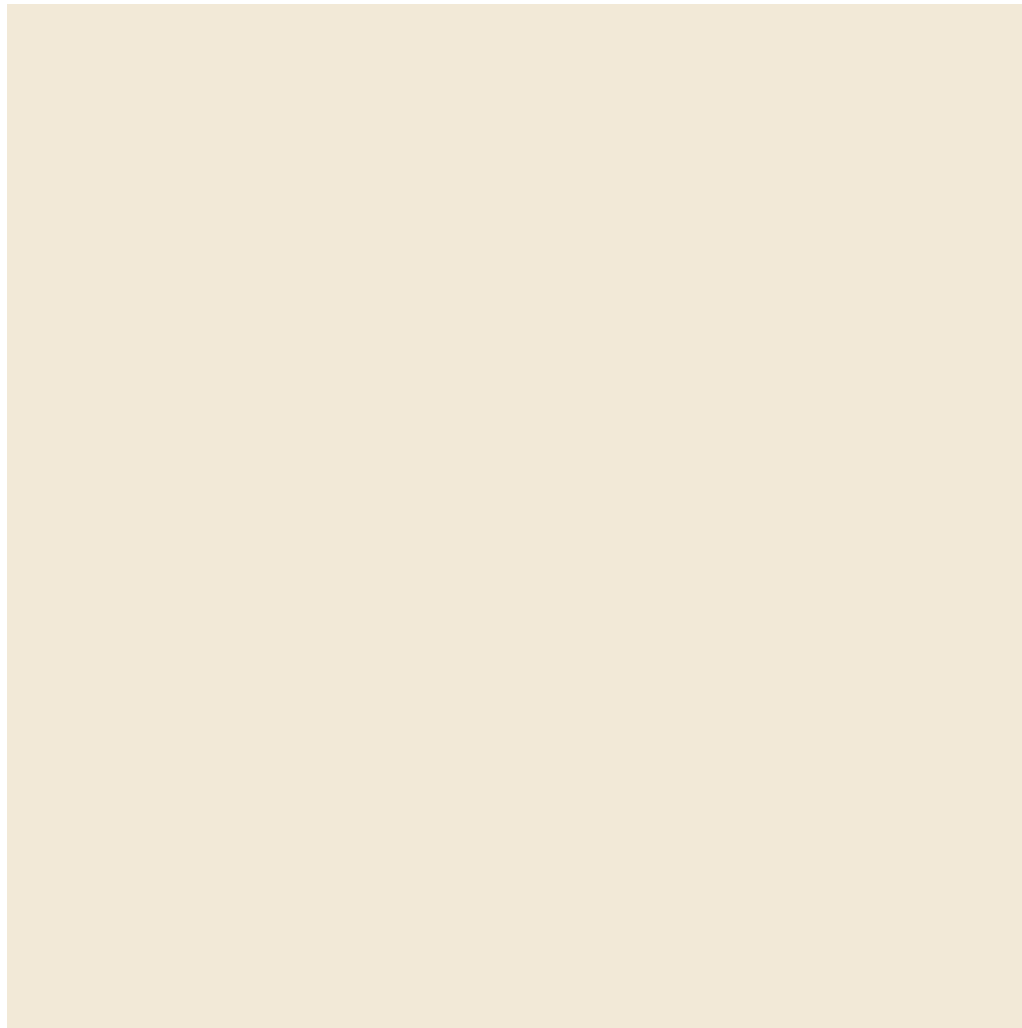

uni gelo

PG 506RT • mate . mat . matt • R9A • 10,5 mm

PG 506P • polido . polished . pulido . poli . poliert • 9,8 mm

597x

KT190



PAVIMENTO / REVESTIMIENTO
FLOOR / WALL TILES
PAVIMENTO / REVESTIMIENTO
REVÊTEMENT DE SOLS / DE MURS
BODENFLIESEN / WANDFLIESEN



MATE
MATT
MATE
MAT
MATT



POLIDO
POLISHED
PULIDO
POLI
POLIERT

GRÉS PORCELÁNICO TÉCNICO
HOMOGENEOUS TECHNICAL PORCELAIN TILES
GRÉS PORCELÁNICO TÉCNICO
GRÉS CÉRAME TECHNIQUE
TECHNIK UNGLASIERTES FEINSTEINZEUG

10.5

597x1190mm

GRÉS PORCELÂNICO TÉCNICO . HOMOGENEOUS TECHNICAL PORCELAIN TILES

GRÉS PORCELÂNICO TÉCNICO . GRÉS CÉRAME TECHNIQUE . TECHNIK UNGLASIERTES FEINSTEINZEUG



PG503 P . UNI GELO 597x1190 mm
PG502 P . UNI METAL 597x1190 mm
PG502 RT . UNI METAL 597x1190 mm



uni metal

- PG 502RT • mate . mat . matt • R9A • 10,5 mm
- PG 502P • polido . polished . pulido . poli . poliert • 9,8 mm

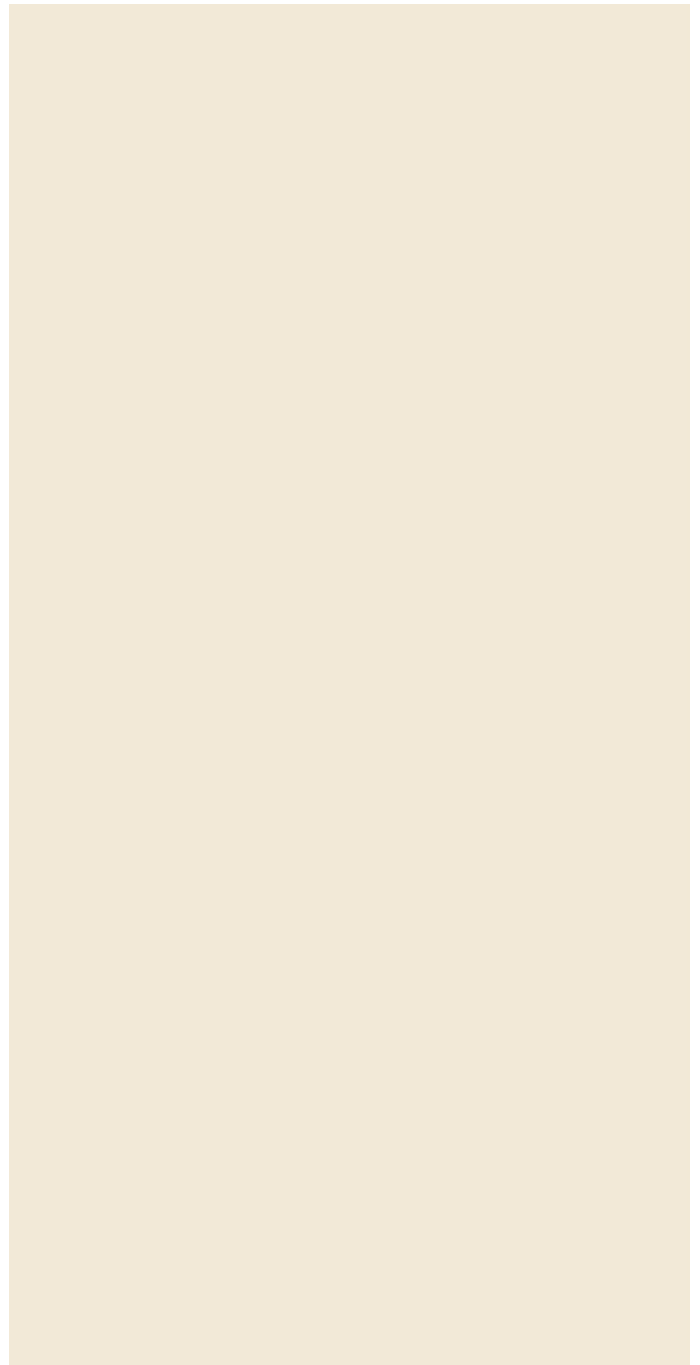

uni gelo

- PG 503RT • mate . mat . matt • R9A • 10,5 mm
- PG 503P • polido . polished . pulido . poli . poliert • 9,8 mm



447

K890



PAVIMENTO / REVESTIMENTO
FLOOR / WALL TILES
PAVIMENTO / REVESTIMIENTO
REVÊTEMENT DE SOLS / DE MURS
BODENFLIESEN / WANDFLIESEN



MATE
MATT
MATE
MAT
MATT



POLIDO
POLISHED
PULIDO
POLI
POLIERT

GRÉS PORCELÂNICO TÉCNICO
HOMOGENEOUS TECHNICAL PORCELAIN TILES
GRÉS PORCELÂNICO TÉCNICO
GRÉS CÉRAME TECHNIQUE
TECHNIK UNGLASIERTES FEINSTEINZEUG

447x890mm

GRÉS PORCELÂNICO TÉCNICO . HOMOGENEOUS TECHNICAL PORCELAIN TILES

GRÉS PORCELÂNICO TÉCNICO . GRÉS CÉRAME TECHNIQUE . TECHNIK UNGLASIERTES FEINSTEINZEUG



PG466RT . UNI GELO 447x890 mm
PG470RT . UNI METAL 447x890 mm



10,5

447x890mm

GRÉS PORCELÂNICO TÉCNICO . HOMOGENEOUS TECHNICAL PORCELAIN TILES
GRÉS PORCELÂNICO TÉCNICO . GRÈS CÉRAME TECHNIQUE . TECHNIK UNGLASIERTES FEINSTEINZEUG

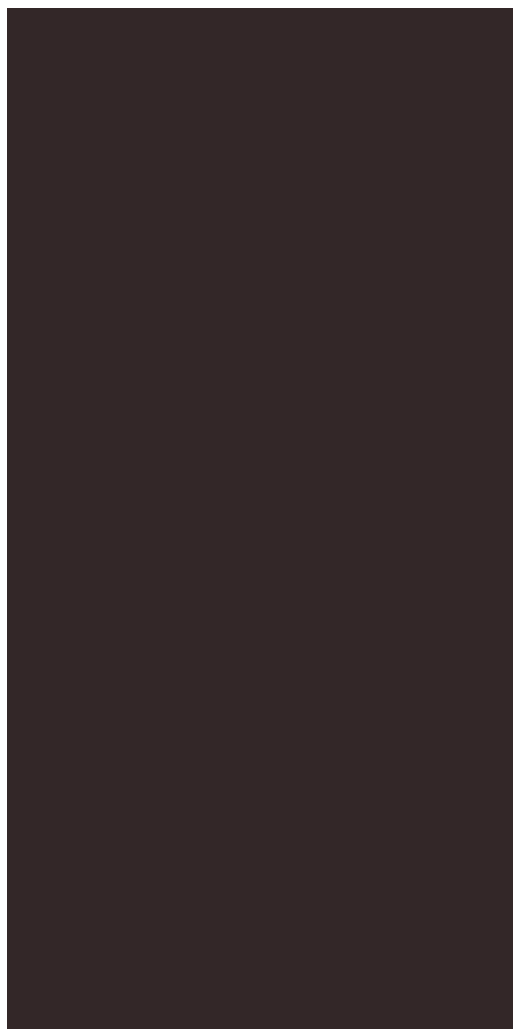

uni carvão

- PG 469RT • mate . mat . matt • R9A • 10,5 mm • U4 P3
- PG 469P • polido . polished . pulido . poli . poliert • 9,8 mm • U3 P3

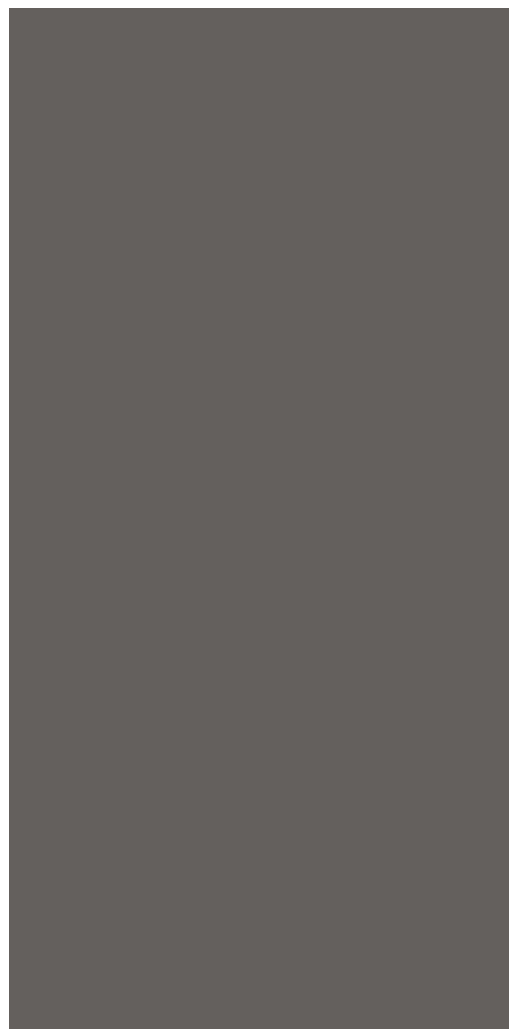

uni metal

- PG 470RT • mate . mat . matt • R9A • 10,5 mm • U4 P3
- PG 470P • polido . polished . pulido . poli . poliert • 9,8 mm • U3 P3

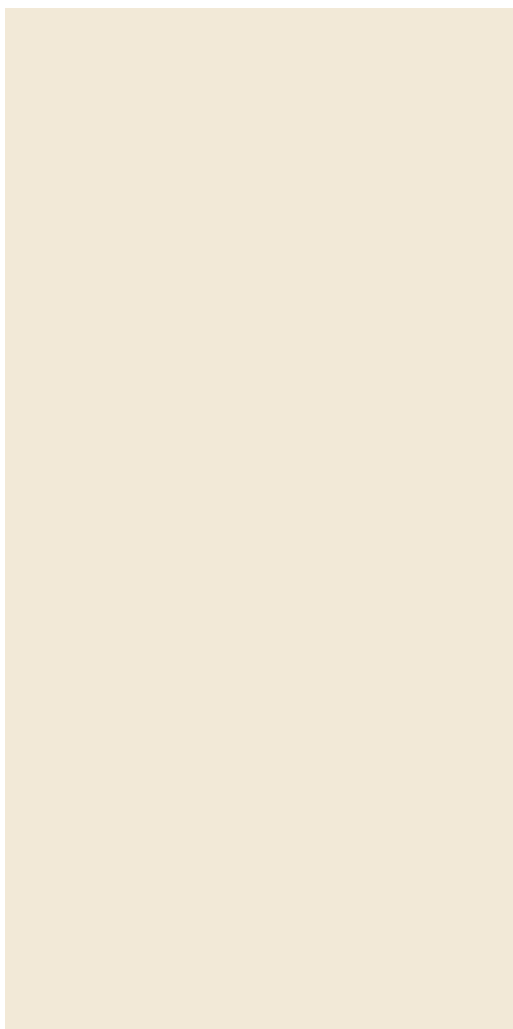

uni gelo

PG 466RT • mate . mat . matt • R9A • 10,5 mm • U4 P3

PG 466P • polido . polished . pulido . poli . poliert • 9,8 mm • U3 P3



PG466RT : UNI GELO 447x890 mm
PG470RT : UNI METAL 447x890 mm

5977

K5597



PAVIMENTO / REVESTIMENTO
FLOOR / WALL TILES
PAVIMENTO / REVESTIMENTO
REVÊTEMENT DE SOLS / DE MURS
BODENFLIESEN / WANDFLIESEN



MATE
MATT
MATE
MAT
MATT



POLIDO
POLISHED
PULIDO
POLI
POLIERT



MACIO
HONED
MACIO
ADOUICIE
WEICH

GRÉS PORCELÁNICO TÉCNICO
HOMOGENEOUS TECHNICAL PORCELAIN TILES
GRÉS PORCELÁNICO TÉCNICO
GRÉS CÉRAME TECHNIQUE
TECHNIK UNGLASIERTES FEINSTEINZEUG

597x597mm

GRÉS PORCELÂNICO TÉCNICO . HOMOGENEOUS TECHNICAL PORCELAIN TILES

GRÉS PORCELÂNICO TÉCNICO . GRÉS CÉRAME TECHNIQUE . TECHNIK UNGLASIERTES FEINSTEINZEUG



PG432P . UNI SOL 597x597 mm
PG277P . UNI CRISTAL 597x597 mm
PG434P . UNI INDIGO 597x597 mm



10,5

597x597mm

GRÉS PORCELÂNICO TÉCNICO . HOMOGENEOUS TECHNICAL PORCELAIN TILES

GRÉS PORCELÂNICO TÉCNICO . GRÈS CÉRAME TECHNIQUE . TECHNIK UNGLASIERTES FEINSTEINZEUG



uni papoila

- PG 431RT • mate . mat . matt • R9A • 10,5 mm • U4 P4
- PG 431M • macio . honed . adoucie . weich • 10,5 mm • U4 P4
- PG 431P • polido . polished . pulido . poli . poliert • 9,8 mm • U3 P3

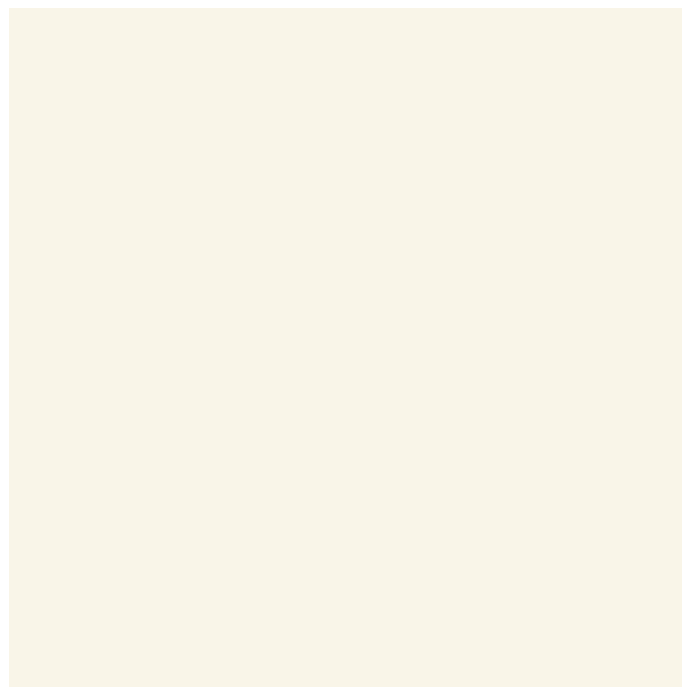

uni cristal

- PG 277RT • mate . mat . matt • R9A • 10,5 mm • U4 P4
- PG 277M • macio . honed . adoucie . weich • 10,5 mm • U4 P4
- PG 277P • polido . polished . pulido . poli . poliert • 9,8 mm • U3 P3



PG175 . UNI CARVÃO 597x597 mm
PG265 . UNI GELO 297x597 mm
PG177 . UNI GELO 597x597 mm
PG431P . UNI PAPOILA 597x597 mm

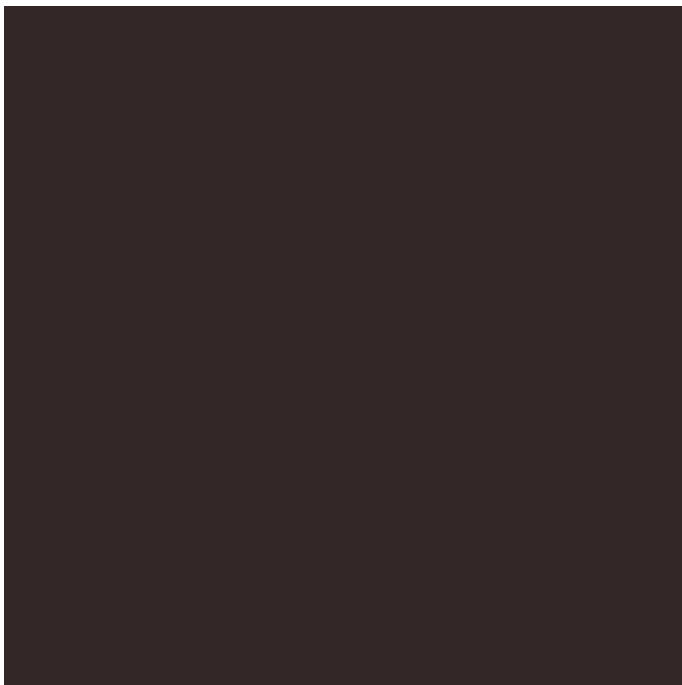

uni carvão

- PG 175 • mate . mat . matt • R9A • 10,5 mm • U4 P4
- PG 175M • macio . honed . adoucie . weich • 10,5 mm • U4 P4
- PG 175P • polido . polished . pulido . poli . poliert • 9,8 mm • U3 P3



uni preto

- PG 471 • mate . mat . matt • R9A • 10,5 mm • U4 P4
- PG 471M • macio . honed . adoucie . weich • 10,5 mm • U4 P4
- PG 471P • polido . polished . pulido . poli . poliert • 9,8 mm • U3 P3
- PGK 471 • mate . mat . matt • R10 • 10,5 mm



fino carvão

- PG 246 • mate . mat . matt • R9A • 10,5 mm • U4 P4
- PG 246P • polido . polished . pulido . poli . poliert • 9,8 mm • U3 P3



95x597 mm

Rodapé cortado . Skirting board rounded edge

Rodapié cortado . Plinthe avec bord arrondi . Sockelleiste mit abgerundeter Kante

VER . SEE . VOIR . SIEHE REF. PG. 186-187 / 190-191

10.5

597x597mm

GRÉS PORCELÂNICO TÉCNICO . HOMOGENEOUS TECHNICAL PORCELAIN TILES

GRÉS PORCELÂNICO TÉCNICO . GRÉS CÉRAME TECHNIQUE . TECHNIK UNGLASIERTES FEINSTEINZEUG



PG184P . FINO ESTANHO 597x597 mm



uni metal

- PG 263 • mate . mat . matt • R9A • 10,5 mm • U4 P4
- PG 263M • macio . honed . adoucie . weich • 10,5 mm • U4 P4
- PG 263P • polido . polished . pulido . poli . poliirt • 9,8 mm • U3 P3
- PGK 263 • mate . mat . matt • R10 • 10,5 mm

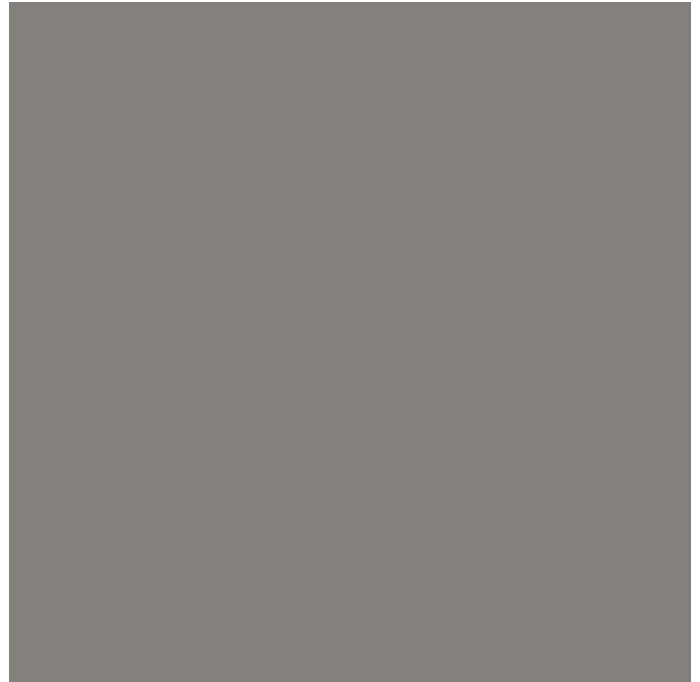

uni estanho

- PG 183 • mate . mat . matt • R9A • 10,5 mm • U4 P4
- PG 183M • macio . honed . adoucie . weich • 10,5 mm • U4 P4
- PG 183P • polido . polished . pulido . poli . poliirt • 9,8 mm • U3 P3
- PGK 183 • mate . mat . matt • R10 • 10,5 mm



uni prata

- PG 430 • mate . mat . matt • R9A • 10,5 mm • U4 P4
- PG 430M • macio . honed . adoucie . weich • 10,5 mm • U4 P4
- PG 430P • polido . polished . pulido . poli . poliirt • 9,8 mm • U3 P3
- PGK 430 • mate . mat . matt • R10 • 10,5 mm



fino estanho

- PG 184 • mate . mat . matt • R9A • 10,5 mm • U4 P4
- PG 184P • polido . polished . pulido . poli . poliirt • 9,8 mm • U3 P3



95x597 mm

Rodapé cortado . Skirting board rounded edge

Rodapié cortado . Plinthe avec bord arrondi . Sockelleiste mit abgerundeter Kante

VER . SEE . VOIR . SIEHE REF. PG. 186-187 / 190-191

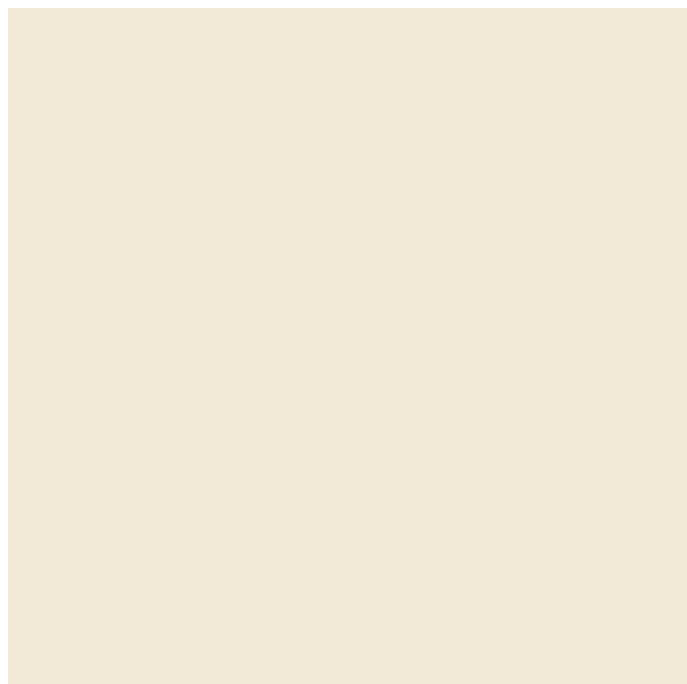
**uni gelo**

- PG 177 • mate . mat . matt • R9A • 10,5 mm • U4 P4
- PG 177M • macio . honed . adoucie . weich • 10,5 mm • U4 P4
- PG 177P • polido . polished . pulido . poli . poliert • 9,8 mm • U3 P3
- PGK 177 • mate . mat . matt • R10 • 10,5 mm

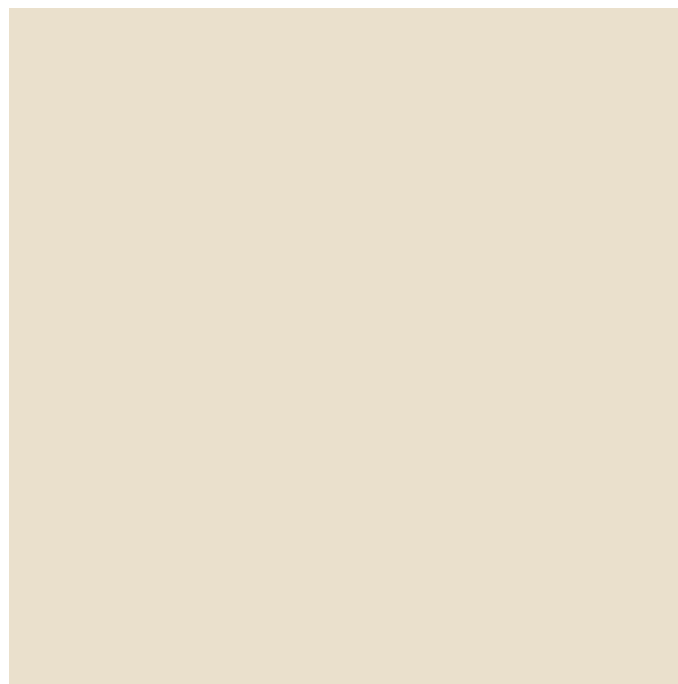
**uni pérola**

- PG 484 • mate . mat . matt • R9A • 10,5 mm
- PG 484M • macio . honed . adoucie . weich • 10,5 mm
- PG 484P • polido . polished . pulido . poli . poliert • 9,8 mm
- PGK 484 • mate . mat . matt • R10 • 10,5 mm

**fino gelo**

- PG 178 • mate . mat . matt • R9A • 10,5 mm • U4 P4
- PG 178P • polido . polished . pulido . poli . poliert • 9,8 mm • U3 P3

**fino pérola**

- PG 527 • mate . mat . matt • R9A • 10,5 mm • U4 P4
- PG 527P • polido . polished . pulido . poli . poliert • 9,8 mm • U3 P3



95x597 mm
Rodapé cortado . Skirting board rounded edge
Rodapié cortado . Plinthe avec bord arrondi . Sockelleiste mit abgerundeter Kante
VER . SEE . VOIR . SIEHE REF. PG. 186-187 / 190-191

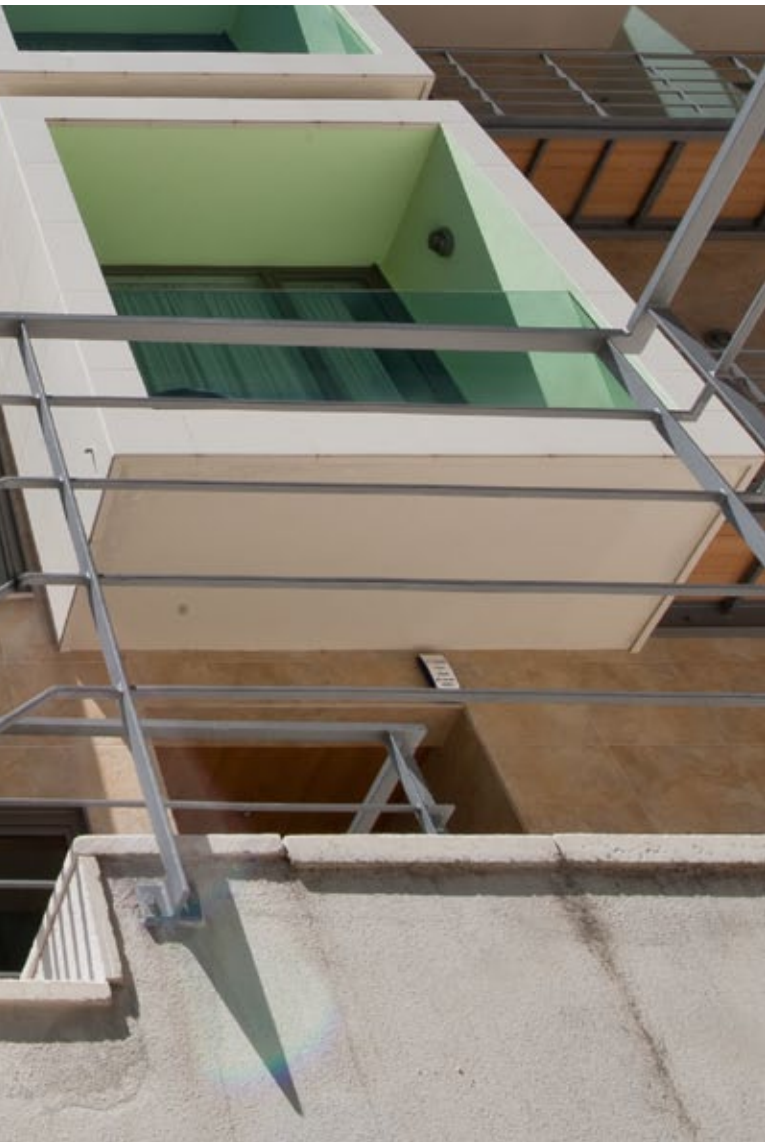
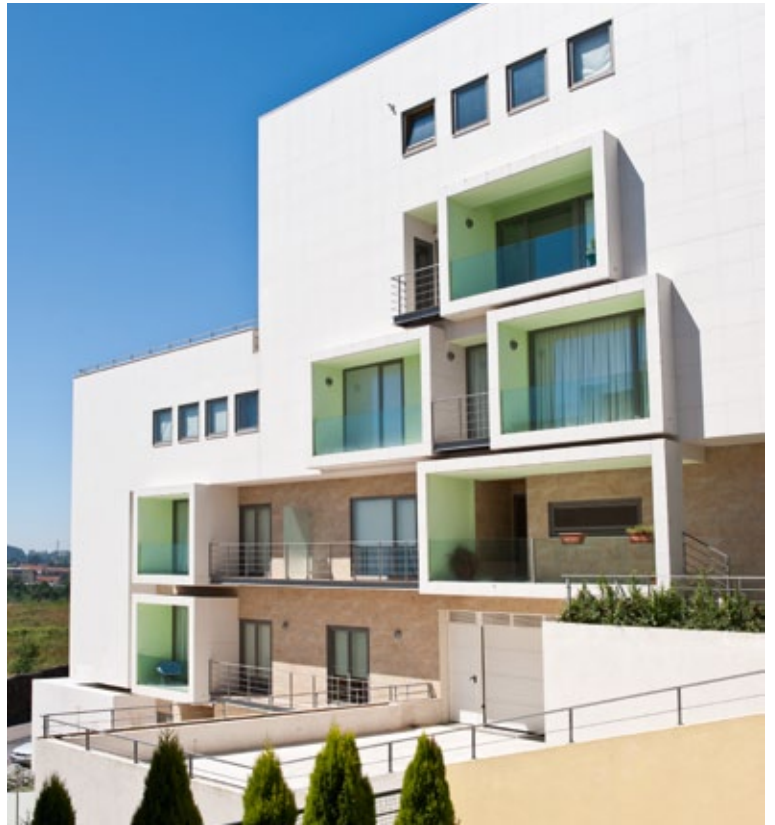

AVELINO MATOS CONSTRUÇÕES - PORTUGAL
ARQª MANUELA SOUTINHO

UNI GELO

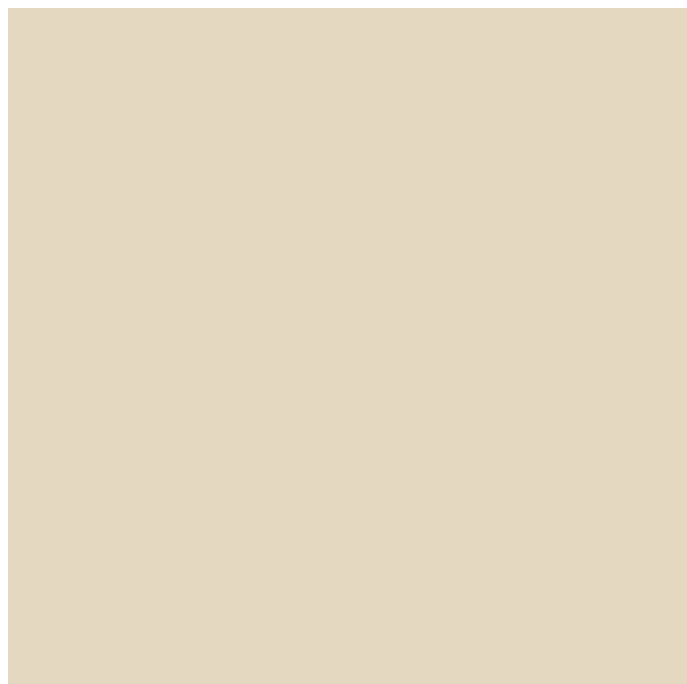
**uni papiro**

PGK 552 • mate . mat . matt • R10 • 10,5 mm

**uni creme**

PG 551 • mate . mat . matt • R9A • 10,5 mm
 PG 551M • macio . honed . adoucie . weich • 10,5 mm
 PG 551P • polido . polished . pulido . poli . poliert • 9,8 mm
 PGK 551 • mate . mat . matt • R10 • 10,5 mm

**uni baunilha**

PG 186 • mate . mat . matt • R9A • 10,5 mm • U4 P4
 PG 186M • macio . honed . adoucie . weich • 10,5 mm • U4 P4
 PG 186P • polido . polished . pulido . poli . poliert • 9,8 mm • U3 P3



95x597 mm
 Rodapé cortado . Skirting board rounded edge
 Rodapié cortado . Plinthe avec bord arrondi . Sockelleiste mit abgerundeter Kante
 VER . SEE . VOIR . SIEHE REF. PG. 186-187

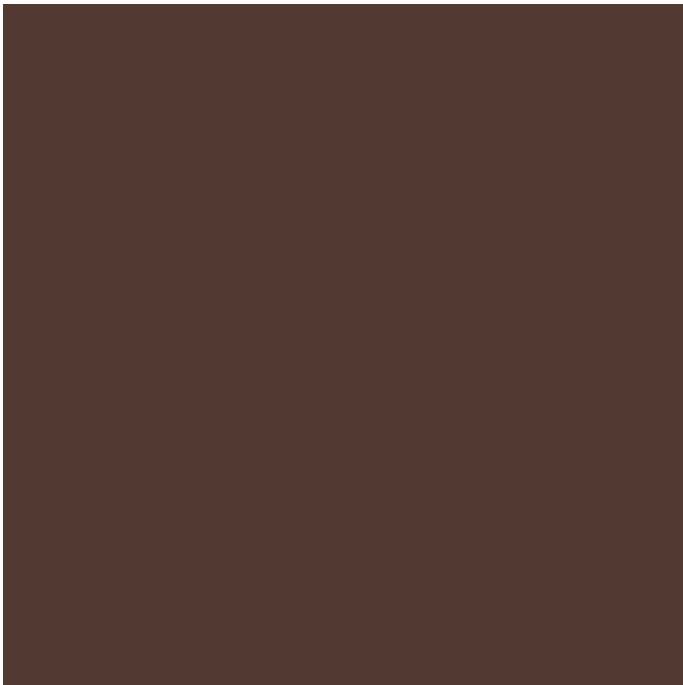

uni chocolate

- PG 278 • mate . mat . matt • R9A • 10,5 mm • U4 P4
- PG 278M • macio . honed . adoucie . weich • 10,5 mm • U4 P4
- PG 278P • polido . polished . pulido . poli . poliert • 9,8 mm • U3 P3



uni moka

- PG 180 • mate . mat . matt • R9A • 10,5 mm • U4 P4
- PG 180M • macio . honed . adoucie . weich • 10,5 mm • U4 P4
- PG 180P • polido . polished . pulido . poli . poliert • 9,8 mm • U3 P3
- PGK 180 • mate . mat . matt • R10 • 10,5 mm



PG180P . UNI MOKA 597x597 mm
 PG276P . UNI MOKA 297x597 mm

10.5

597x597mm

GRÉS PORCELÂNICO TÉCNICO . HOMOGENEOUS TECHNICAL PORCELAIN TILES
GRÉS PORCELÂNICO TÉCNICO . GRÉS CÉRAME TECHNIQUE . TECHNIK UNGLASIERTES FEINSTEINZEUG



PG67 . UNI PERGAMON 297x297 mm
PG12 . UNI MOKA 297x297 mm
PG433RT . UNI TANGERINA 597x597 mm



uni sol

- PG 432RT • mate . mat . matt • R9A • 10,5 mm • U4 P4
- PG 432M • macio . honed . adoucie . weich • 10,5 mm • U4 P4
- PG 432P • polido . polished . pulido . poli . poliert • 9,8 mm • U3 P3



uni tangerina

- PG 433RT • mate . mat . matt • R9A • 10,5 mm • U4 P4
- PG 433M • macio . honed . adoucie . weich • 10,5 mm • U4 P4
- PG 433P • polido . polished . pulido . poli . poliert • 9,8 mm • U3 P3



uni tropical

- PG 435RT • mate . mat . matt • R9A • 10,5 mm • U4 P4
- PG 435M • macio . honed . adoucie . weich • 10,5 mm • U4 P4
- PG 435P • polido . polished . pulido . poli . poliert • 9,8 mm • U3 P3



uni indigo

- PG 434RT • mate . mat . matt • R9A • 10,5 mm • U4 P4
- PG 434M • macio . honed . adoucie . weich • 10,5 mm • U4 P4
- PG 434P • polido . polished . pulido . poli . poliert • 9,8 mm • U3 P3



95x597 mm

Rodapé cortado . Skirting board rounded edge

Rodapié cortado . Plinthe avec bord arrondi . Sockelleiste mit abgerundeter Kante

VER . SEE . VOIR . SIEHE REF. PG. 186-187

597x597mm

GRÉS PORCELÂNICO TÉCNICO . HOMOGENEOUS TECHNICAL PORCELAIN TILES

GRÉS PORCELÂNICO TÉCNICO . GRÉS CÉRAME TECHNIQUE . TECHNIK UNGLASIERTES FEINSTEINZEUG



PG3 . UNI GELO 297x297 mm
PG435P . UNI TROPICAL 597x597 mm



2017

K597



PAVIMENTO / REVESTIMENTO
FLOOR / WALL TILES
PAVIMENTO / REVESTIMIENTO
REVÊTEMENT DE SOLS / DE MURS
BODENFLIESEN / WANDFLIESEN



MATE
MATT
MATE
MAT
MATT



POLIDO
POLISHED
PULIDO
POLI
POLIERT



REVESTIMENTO
WALL
REVESTIMIENTO
FAÏENCE
WANDFLIESEN



BRILHO
GLOSSY
BRILLANTE
BRILLANTE
GLÄNZENDE

GRÉS PORCELÂNICO TÉCNICO
HOMOGENEOUS TECHNICAL PORCELAIN TILES
GRÉS PORCELÂNICO TÉCNICO
GRÉS CÉRAME TECHNIQUE
TECHNIK UNGLASIERTES FEINSTEINZEUG

REVESTIMENTO UNICOLOR BRILHANTE
UNI GLOSSY WALL TILE
REVESTIMIENTO UNICOLOR BRILLANTE
FAÏENCE UNI BRILLANTE
GLÄNZENDE STEINGUT WANDFLIESEN UNI

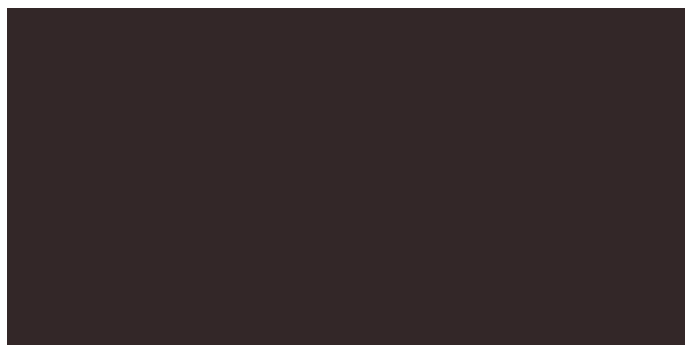
**uni carvão**

- PG 269 • mate . mat . matt • R9A • 9,2 mm • U4 P3
- PG 269P • polido . polished . pulido . poli . poliert • 8,5 mm • U3 P3

**uni estanho**

- PG 207 • mate . mat . matt • R9A • 9,2 mm • U4 P3
- PG 207P • polido . polished . pulido . poli . poliert • 8,5 mm • U3 P3
- PGK 207 • mate . mat . matt • R10 • 9,2 mm

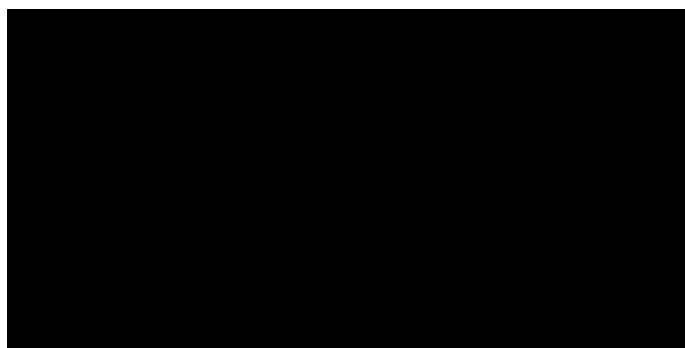
**uni preto**

- PGK 549 • mate . mat . matt • R10 • 9,2 mm

**uni ZINCO**

- PGK 546 • mate . mat . matt • R10 • 9,2 mm

**uni metal**

- PG 268 • mate . mat . matt • R9A • 9,2 mm • U4 P3
- PG 268P • polido . polished . pulido . poli . poliert • 8,5 mm • U3 P3
- PGK 268 • mate . mat . matt • R10 • 9,2 mm

**uni prata**

- PG 280 • mate . mat . matt • R9A • 9,2 mm • U4 P3
- PG 280P • polido . polished . pulido . poli . poliert • 8,5 mm
- PGK 280 • mate . mat . matt • R10 • 9,2 mm

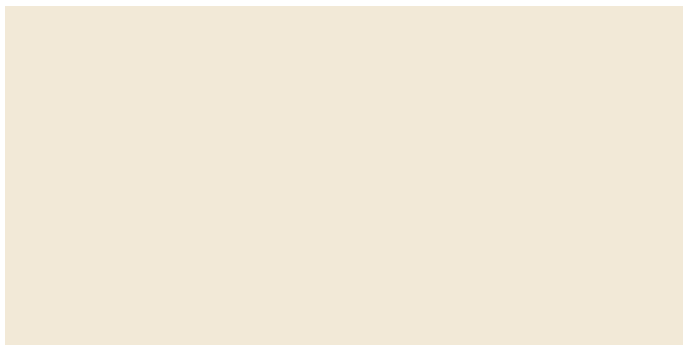

uni gelo

- PG 265 • mate . mat . matt • R9A • 9,2 mm • U4 P3
- PG 265P • polido . polished . pulido . poli . poliert • 8,5 mm • U3 P3
- PGK 265 • mate . mat . matt • R10 • 9,2 mm



uni creme

- PG 548 • mate . mat . matt • R9A • 9,2 mm
- PG 548P • polido . polished . pulido . poli . poliert • 8,5 mm
- PGK 548 • mate . mat . matt • R10 • 9,2 mm

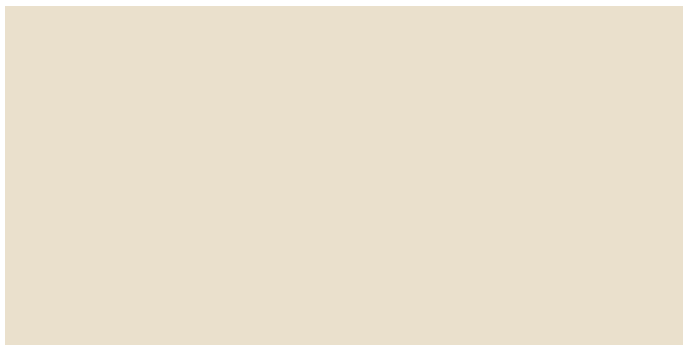

uni pérola

- PG 517 • mate . mat . matt • R9A • 9,2 mm
- PG 517P • polido . polished . pulido . poli . poliert • 8,5 mm
- PGK 517 • mate . mat . matt • R10 • 9,2 mm

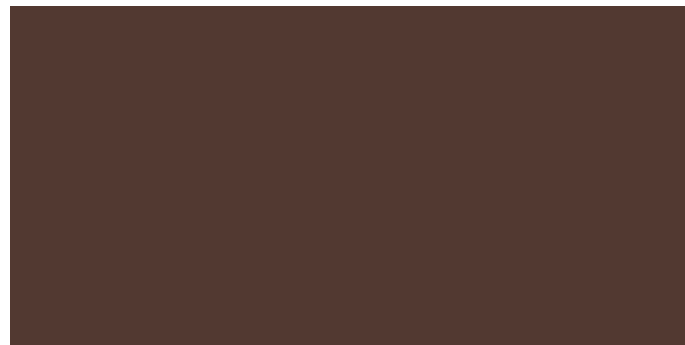

uni chocolate

- PG 292 • mate . mat . matt • R9A • 9,2 mm • U4 P3
- PG 292P • polido . polished . pulido . poli . poliert • 8,5 mm • U3 P3



uni papiro

- PGK 547 • mate . mat . matt • R10 • 9,2 mm

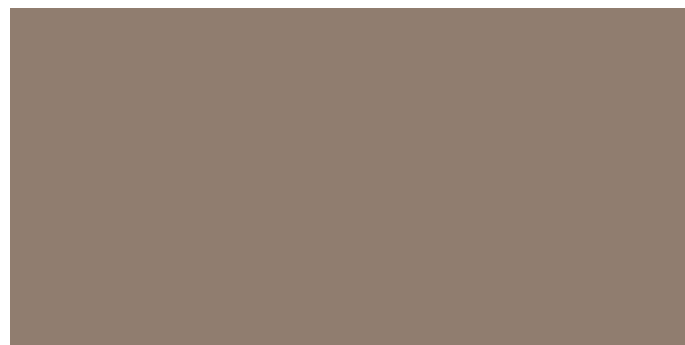

uni moka

- PG 276 • mate . mat . matt • R9A • 9,2 mm • U4 P3
- PG 276P • polido . polished . pulido . poli . poliert • 8,5 mm • U3 P3
- PGK 276 • mate . mat . matt • R10 • 9,2 mm

11,9

297x597mm

REVESTIMENTO UNICOLOR BRILHANTE . UNI GLOSSY WALL TILE

REVESTIMIENTO UNICOLOR BRILLANTE . FAÏENCE UNI BRILLANTE . GLÄNZENDE STEINGUT WANDFLIESEN UNI

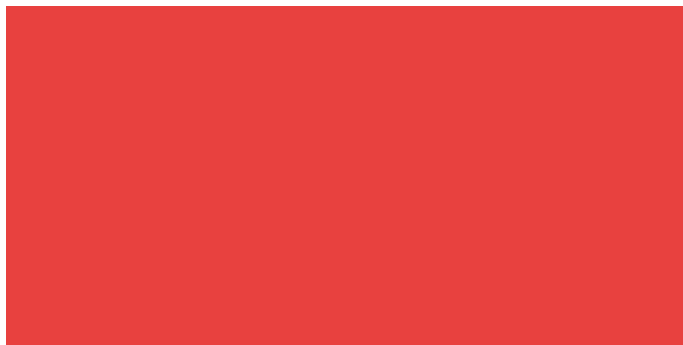

uni papoila

PC 429 • brilho . glossy . brillo . brilliant . glänzend • 11,9 mm

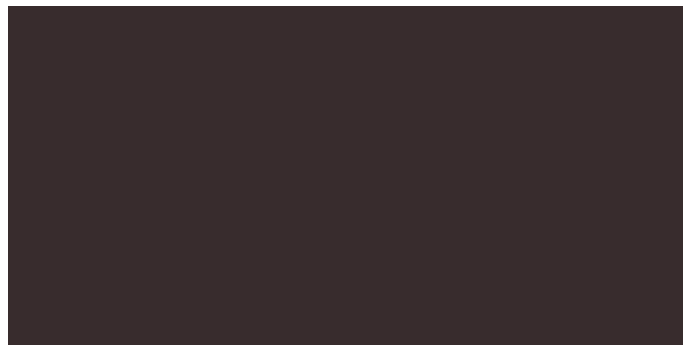

uni carvão

PC 269 • brilho . glossy . brillo . brilliant . glänzend • 11,9 mm

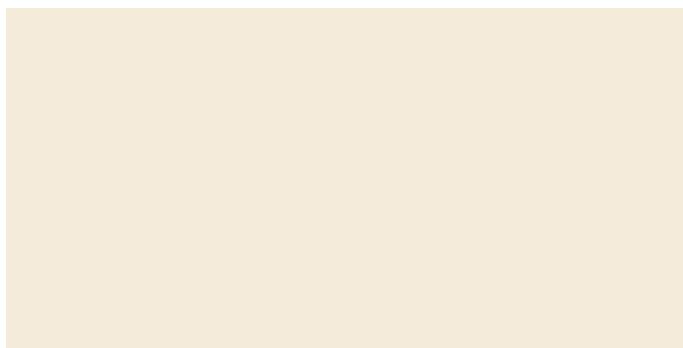

uni pergamon

PC 288 • brilho . glossy . brillo . brilliant . glänzend • 11,9 mm

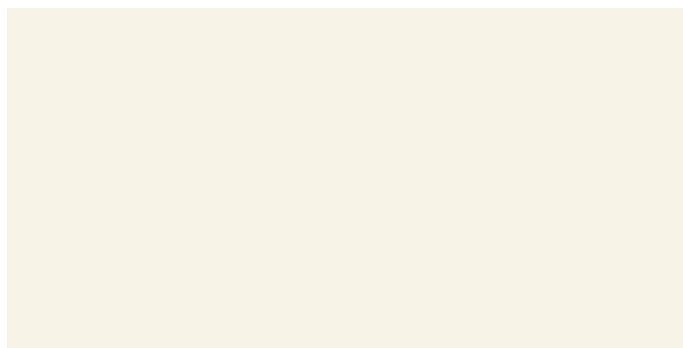

uni gelo

PC 265 • brilho . glossy . brillo . brilliant . glänzend • 11,9 mm

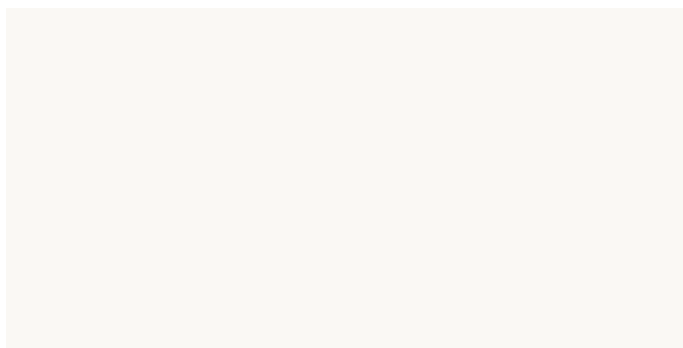

uni cristal

PC 281 • brilho . glossy . brillo . brilliant . glänzend • 11,9 mm



uni lima

PC 290 • brilho . glossy . brillo . brilliant . glänzend • 11,9 mm



PC429 . UNI PAPAOLA 297x597 mm



197x

K597



REVESTIMENTO
WALL
REVESTIMIENTO
FAÏENCE
WANDFLIESEN

BRILHO
GLOSSY
BRILLANTE
BRILLANTE
GLÄNZENDE

REVESTIMENTO UNICOLOR BRILHANTE
UNI GLOSSY WALL TILE
REVESTIMIENTO UNICOLOR BRILLANTE
FAÏENCE UNI BRILLANTE
GLÄNZENDE STEINGUT WANDFLIESEN UNI

197x597mm

REVESTIMENTO UNICOLOR BRILHANTE . UNI GLOSSY WALL TILE

REVESTIMIENTO UNICOLOR BRILLANTE . FAÏENCE UNI BRILLANTE . GLÄNZENDE STEINGUT WANDFLIESEN UNI



PC329 . UNI GELO 197x597 mm
PC327 . UNI CARVÃO 197x597 mm
PC19/001 . CEREJA/DOURADO 197x597 mm
PG177P . UNI GELO 597x597 mm
PG175P . UNI CARVÃO 597x597 mm



197x597mm

REVESTIMENTO UNICOLOR BRILHANTE . UNI GLOSSY WALL TILE

REVESTIMIENTO UNICOLOR BRILLANTE . FAÏENCE UNI BRILLANTE . GLÄNZENDE STEINGUT WANDFLIESEN UNI



PC329 . UNI GELO 197x597 mm
PC324 . UNI LIMA 197x597 mm
PC331 . UNI LAGO 197x597 mm
PG177P . UNI GELO 597x597 mm



PC330 . UNI CRISTAL 197x597 mm
PC361 . UNI CEREJA 197x597 mm
PCD330.8 . 197x597 mm
PG277P . UNI CRISTAL 597x597 mm

11,6

197x597mm

REVESTIMENTO UNICOLOR BRILHANTE . UNI GLOSSY WALL TILE
REVESTIMIENTO UNICOLOR BRILLANTE . FAÏENCE UNI BRILLANTE . GLÄNZENDE STEINGUT WANDFLIESEN UNI



uni cereja

PC 361 • brilho . glossy . brillo . brilliant . glänzend • 11,6 mm

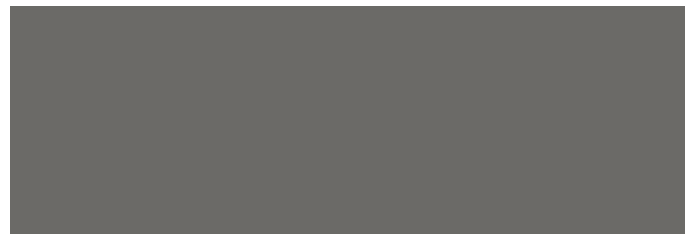

uni metal

PC 326 • brilho . glossy . brillo . brilliant . glänzend • 11,6 mm



uni papoila

PC 472 • brilho . glossy . brillo . brilliant . glänzend • 11,6 mm

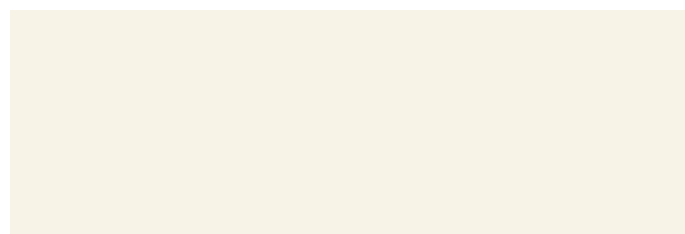

uni gelo

PC 329 • brilho . glossy . brillo . brilliant . glänzend • 11,6 mm

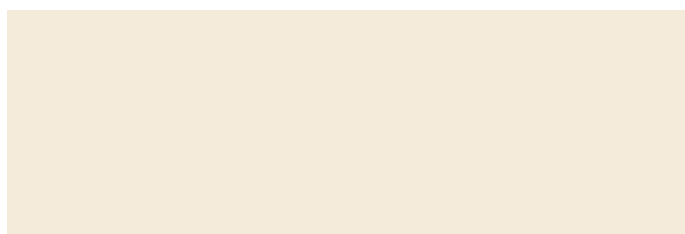

uni pergamon

PC 479 • brilho . glossy . brillo . brilliant . glänzend • 11,6 mm



uni papaia

PC 323 • brilho . glossy . brillo . brilliant . glänzend • 11,6 mm

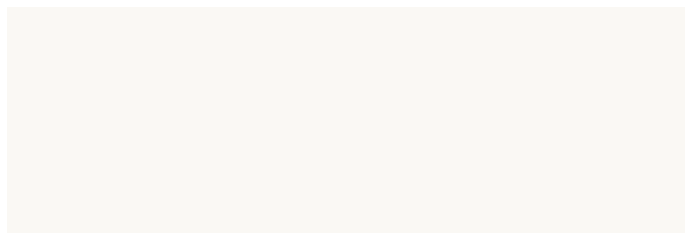

uni cristal

PC 330 • brilho . glossy . brillo . brilliant . glänzend • 11,6 mm

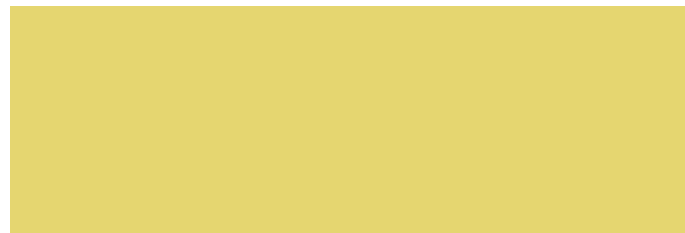

uni gema

PC 362 • brilho . glossy . brillo . brilliant . glänzend • 11,6 mm

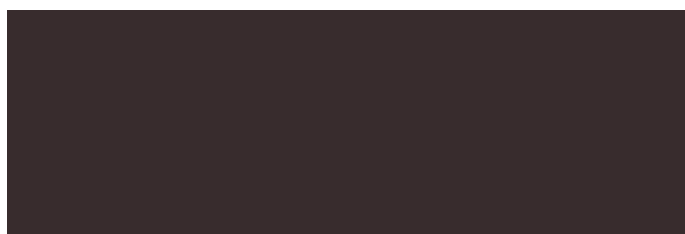

uni carvão

PC 327 • brilho . glossy . brillo . brilliant . glänzend • 11,6 mm



uni lima

PC 324 • brilho . glossy . brillo . brilliant . glänzend • 11,6 mm



uni lago

PCD 331 • brilho . glossy . brillo . brilliant . glänzend • 11,6 mm



uni indigo

PCD 360 • brilho . glossy . brillo . brilliant . glänzend • 11,6 mm



gelo

PCD 329.2 • 11,6 mm



PCD 329 • 11,6 mm



crystal

PCD 330.9 • 11,6 mm



PCD 330.2 • 11,6 mm



pergamon

PCD 479 • 11,6 mm



PCD 330.3 • 11,6 mm

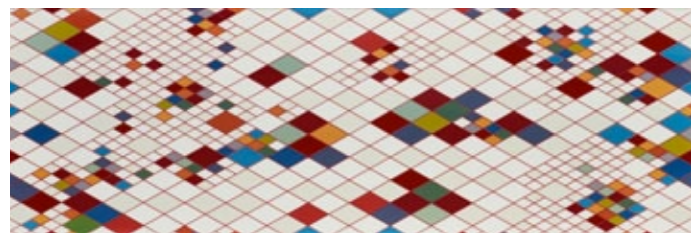

PCD 330.8 • 11,6 mm

11.6

197x597mm

REVESTIMENTO UNICOLOR BRILHANTE . UNI GLOSSY WALL TILE

REVESTIMIENTO UNICOLOR BRILLANTE . FAÏENCE UNI BRILLANTE . GLÄNZENDE STEINGUT WANDFLIESEN UNI



PC327 . UNI CARVÃO 197x597 mm
PC19/001 . CEREJA/DOURADO 197x597 mm
PG175P . UNI CARVÃO 597x597 mm

307x307mm WALL TILES MOSAIC ≈ 19x19 mm

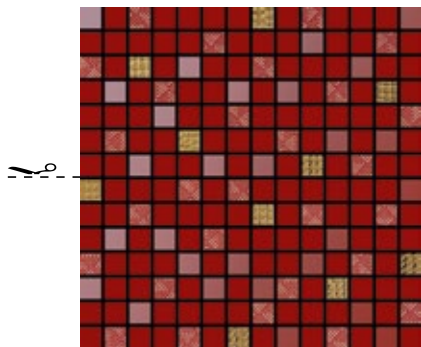

PC19/001 • cereja / dourado
brilho . glossy . brillo . brilliant . glänzend

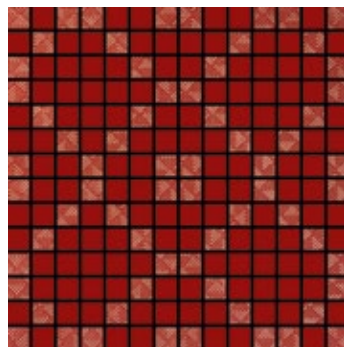

PC19/002 • cereja / geométrico
brilho . glossy . brillo . brilliant . glänzend

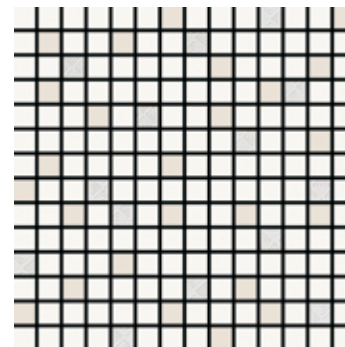

PC19/003 • cristal / lustre
brilho . glossy . brillo . brilliant . glänzend

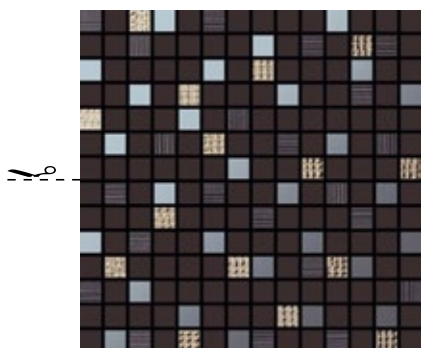

PC19/004 • carvão / prateado
brilho . glossy . brillo . brilliant . glänzend

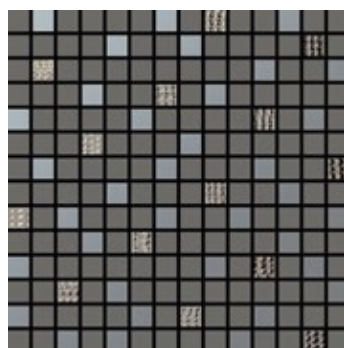

PC19/005 • metal / prateado
brilho . glossy . brillo . brilliant . glänzend

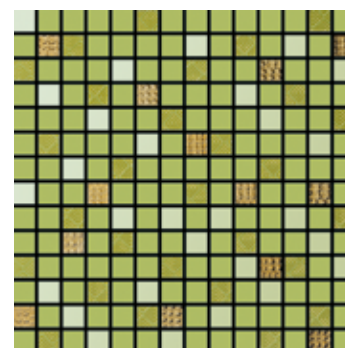

PC19/006 • lima / dourado
brilho . glossy . brillo . brilliant . glänzend

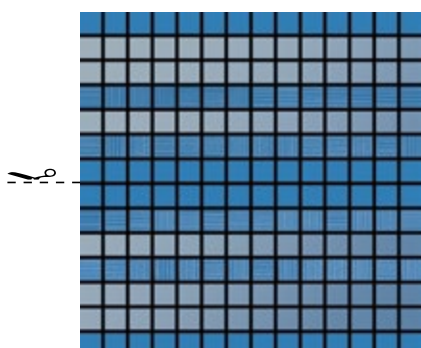

PC19/007 • lago / riscas
brilho . glossy . brillo . brilliant . glänzend

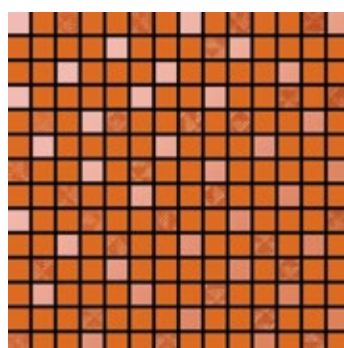

PC19/008 • papaia / lustre
brilho . glossy . brillo . brilliant . glänzend

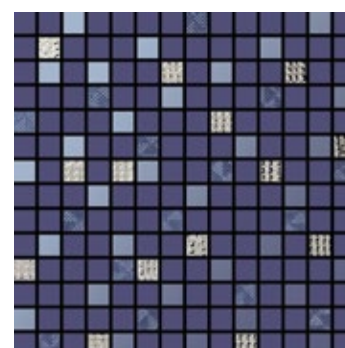

PC19/009 • indigo / prateado
brilho . glossy . brillo . brilliant . glänzend

4477



PAVIMENTO / REVESTIMENTO

MATE

POLIDO

MACIO

FLOOR / WALL TILES

MATT

POLISHED

HONED

PAVIMENTO / REVESTIMENTO

MATE

PULIDO

MACIO

REVÊTEMENT DE SOLS / DE MURS

MAT

POLI

ADOUÇIE

BODENFLIESEN / WANDFLIESEN

MATT

POLIERT

WEICH

GRÉS PORCELÂNICO TÉCNICO
HOMOGENEOUS TECHNICAL PORCELAIN TILES
GRÉS PORCELÂNICO TÉCNICO
GRÉS CÉRAME TECHNIQUE
TECHNIK UNGLASIERTES FEINSTEINZEUG

447x447mm

GRÉS PORCELÂNICO TÉCNICO . HOMOGENEOUS TECHNICAL PORCELAIN TILES
GRÉS PORCELÂNICO TÉCNICO . GRÉS CÉRAME TECHNIQUE . TECHNIK UNGLASIERTES FEINSTEINZEUG



PG44 . UNI ESTANHO 147x147 mm
PG46 . UNI GELO 147x147 mm
PG158 . UNI ESTANHO 447x447 mm
PG159 . FINO ESTANHO 447x447 mm

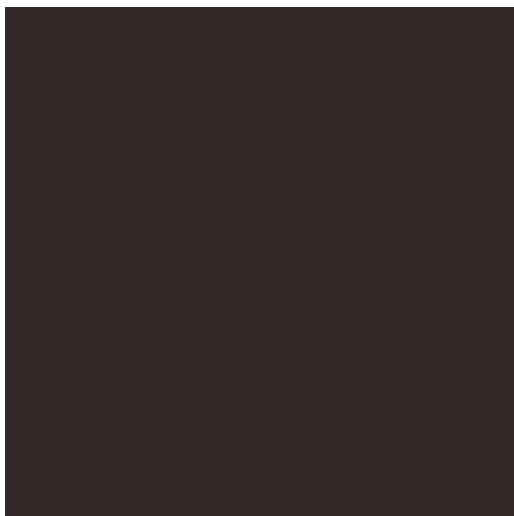

**uni carvão**

- PG 165 • mate . mat . matt • R9A • 9,2 mm • U4 P4
- PG 165M • macio . honed . adoucie . weich • 9,2 mm • U4 P4
- PG 165P • polido . polished . pulido . poli . poliert • 8,5 mm • U3 P3

**uni estanho**

- PG 158 • mate . mat . matt • R9A • 9,2 mm • U4 P4
- PG 158M • macio . honed . adoucie . weich • 9,2 mm • U4 P4
- PG 158P • polido . polished . pulido . poli . poliert • 8,5 mm • U3 P3

**fino carvão**

- PG 245 • mate . mat . matt • R9A • 9,2 mm • U4 P4
- PG 245P • polido . polished . pulido . poli . poliert • 8,5 mm • U3 P3

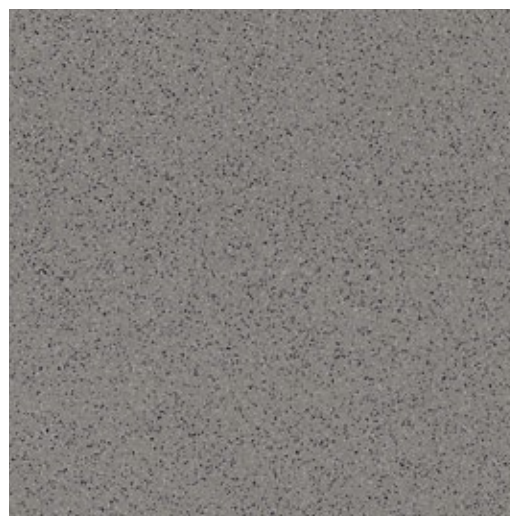
**fino estanho**

- PG 159 • mate . mat . matt • R9A • 9,2 mm • U4 P4
- PG 159P • polido . polished . pulido . poli . poliert • 8,5 mm • U3 P3



95x447 mm

Rodapé cortado . Skirting board rounded edge

Rodapié cortado . Plinthe avec bord arrondi . Sockelleiste mit abgerundeter Kante

VER . SEE . VOIR . SIEHE REF. PG. 186-187 / 190-191



uni prata

- PG 171 • mate . mat . matt • R9A • 9,2 mm • U4 P4
- PG 171M • macio . honed . adoucie . weich • 9,2 mm • U4 P4
- PG 171P • polido . polished . pulido . poli . poliert • 8,5 mm • U3 P3

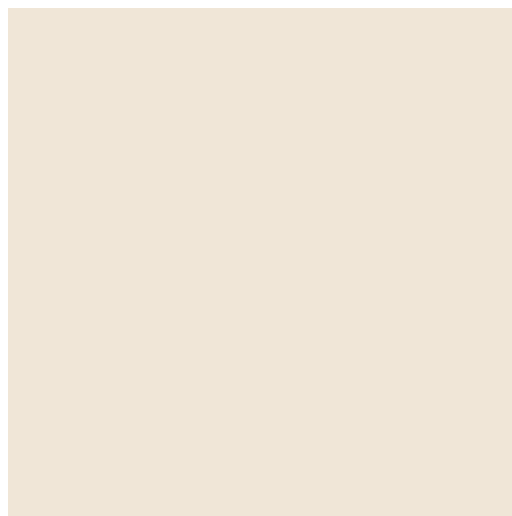

PG171P . UNI PRATA 447x447 mm

**uni pergamon**

- PG 164 • mate . mat . matt • R9A • 9,2 mm • U4 P4
- PG 164M • macio . honed . adoucie . weich • 9,2 mm • U4 P4
- PG 164P • polido . polished . pulido . poli . poliert • 8,5 mm • U3 P3



PG164P . UNI PERGAMON 447x447 mm

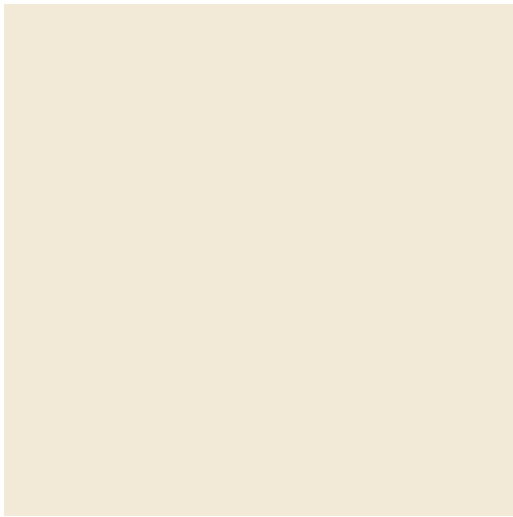

uni gelo

- PG 167 • mate . mat . matt • R9A • 9,2 mm • U4 P4
- PG 167M • macio . honed . adoucie . weich • 9,2 mm • U4 P4
- PG 167P • polido . polished . pulido . poli . poliert • 8,5 mm • U3 P3

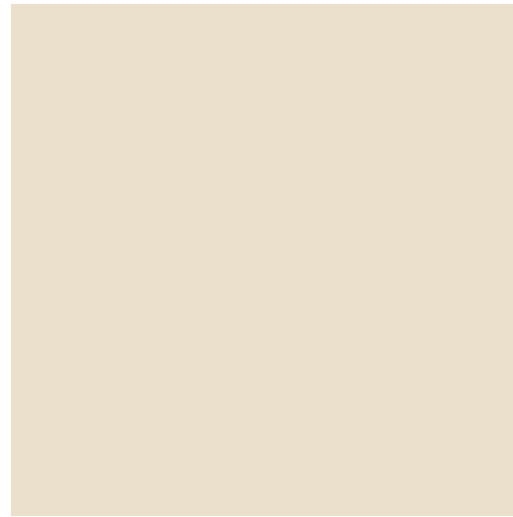

uni pérola

- PG 524 • mate . mat . matt • R9A • 9,2 mm
- PG 524M • macio . honed . adoucie . weich • 9,2 mm
- PG 524P • polido . polished . pulido . poli . poliert • 8,5 mm



fino gelo

- PG 169 • mate . mat . matt • R9A • 9,2 mm • U4 P4
- PG 169P • polido . polished . pulido . poli . poliert • 8,5 mm • U3 P3



fino pérola

- PG 526 • mate . mat . matt • R9A • 9,2 mm
- PG 526P • polido . polished . pulido . poli . poliert • 8,5 mm



95x447 mm

Rodapé cortado . Skirting board rounded edge

Rodapié cortado . Plinthe avec bord arrondi . Sockelleiste mit abgerundeter Kante

VER . SEE . VOIR . SIEHE REF. PG. 186-187 / 190-191

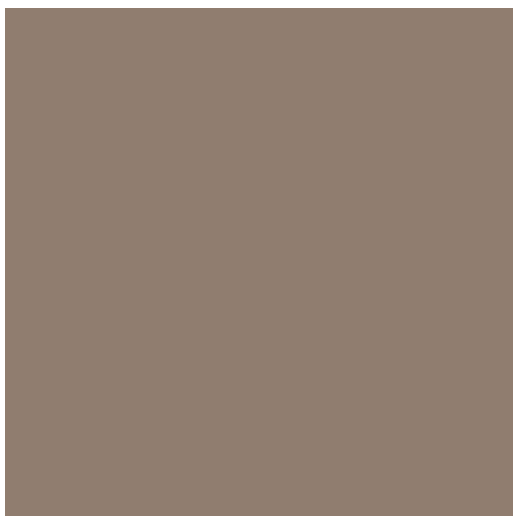
**uni moka**

- PG 172 • mate . mat . matt • R9A • 9,2 mm • U4 P4
- PG 172M • macio . honed . adoucie . weich • 9,2 mm • U4 P4
- PG 172P • polido . polished . pulido . poli . poliert • 8,5 mm • U3 P3

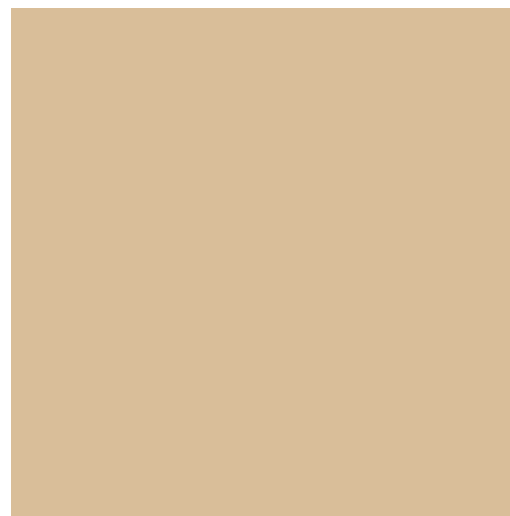
**uni baunilha**

- PG 162 • mate . mat . matt • R9A • 9,2 mm • U4 P4
- PG 162M • macio . honed . adoucie . weich • 9,2 mm • U4 P4
- PG 162P • polido . polished . pulido . poli . poliert • 8,5 mm • U3 P3

**fino moka**

- PG 173 • mate . mat . matt • R9A • 9,2 mm • U4 P4
- PG 173P • polido . polished . pulido . poli . poliert • 8,5 mm • U3 P3

**fino baunilha**

- PG 163 • mate . mat . matt • R9A • 9,2 mm • U4 P4
- PG 163P • polido . polished . pulido . poli . poliert • 8,5 mm • U3 P3



95x447 mm

Rodapé cortado . Skirting board rounded edge

Rodapié cortado . Plinthe avec bord arrondi . Sockelleiste mit abgerundeter Kante

VER . SEE . VOIR . SIEHE REF. PG. 186-187 / 190-191



PG163P . FINO BAUNILHA 447x447 mm

2017x

K297



PAVIMENTO / REVESTIMENTO

MATE

POLIDO

MACIO

FLOOR / WALL TILES

MATT

POLISHED

HONED

PAVIMENTO / REVESTIMIENTO

MATE

PULIDO

MACIO

REVÊTEMENT DE SOLS / DE MURS

MAT

POLI

ADOUICIE

BODENFLIESEN / WANDFLIESEN

MATT

POLIERT

WEICH

PAVIMENTO / REVESTIMENTO

MATE

FLOOR / WALL TILES

MATT

PAVIMENTO / REVESTIMIENTO

MATE

REVÊTEMENT DE SOLS / DE MURS

MAT

BODENFLIESEN / WANDFLIESEN

MATT

GRÉS PORCELÁNICO TÉCNICO

HOMOGENEOUS TECHNICAL PORCELAIN TILES

GRÉS PORCELÁNICO TÉCNICO

GRÉS CÉRAME TECHNIQUE

TECHNIK UNGLASIERTES FEINSTEINZEUG

GRÉS VIDRADO

GLAZED VITRIFIED TILES

GRÉS VIDRIADO

GRÉS ÉMAILLÉ

GLASIERTES STEINZEUG

297x297mm

GRÉS PORCELÂNICO TÉCNICO . HOMOGENEOUS TECHNICAL PORCELAIN TILES
GRÉS PORCELÂNICO TÉCNICO . GRÈS CÉRAME TECHNIQUE . TECHNIK UNGLASIERTES FEINSTEINZEUG



PG3P . UNI GELO 297x297 mm
PG68RT . UNI PAPOILA 297x297 mm
PG24027 . FINO METAL 297x297 mm (22x47 mm)
PG27P . FINO METAL 297x297 mm



**uni papoila**

- PG 68RT • mate . mat . matt • R9A • 8,3 mm • U4 P4
 PG 68M • macio . honed . adoucie . weich • 8,3 mm • U4 P4
 PG 68P • polido . polished . pulido . poli . poliert • 7,6 mm
 • U3 P3

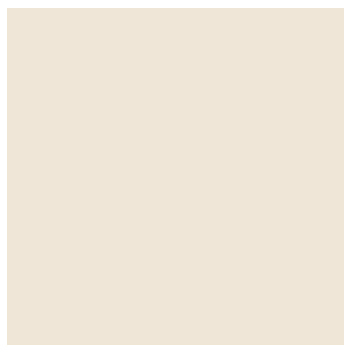
**uni pergamon**

- PG 67 • mate . mat . matt • R9A • 8,3 mm • U4 P4
 PG 67M • macio . honed . adoucie . weich • 8,3 mm • U4 P4
 PG 67P • polido . polished . pulido . poli . poliert • 7,6 mm
 • U3 P3

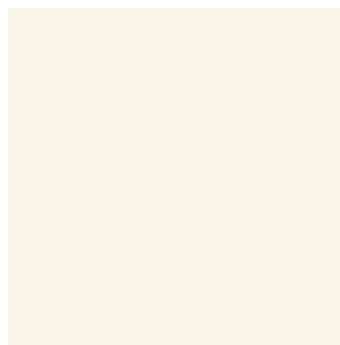
**uni cristal**

- PG 92RT • mate . mat . matt • R9A • 8,3 mm • U4 P4
 PG 92M • macio . honed . adoucie . weich • 8,3 mm • U4 P4
 PG 92P • polido . polished . pulido . poli . poliert • 7,6 mm
 • U3 P3

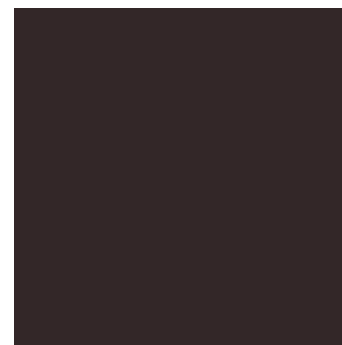
**uni carvão**

- PG 23 • mate . mat . matt • R9A • 8,3 mm • U4 P4
 PG 23M • macio . honed . adoucie . weich • 8,3 mm • U4 P4
 PG 23P • polido . polished . pulido . poli . poliert • 7,6 mm
 • U3 P3

**fino carvão**

- PG 244 • mate . mat . matt • R9A • 8,3 mm • U4 P4
 PG 244P • polido . polished . pulido . poli . poliert • 7,6 mm
 • U3 P3



95x297 mm
 Rodapé cortado . Cut skirting board rounded edge . Rodapié cortado
 Plinthe avec bord arrondi . Sockelleiste mit abgerundeter Kante geschnitten
 VER . SEE . VOIR . SIEHE REF. PG. 186-187 / 190-191



97x297 mm
 Rodapé prensado curvo mate . Pressed cove base sit-on matt
 Rodapié prensado curvo mate . Plinthe à recouvrement mat . Hohlkehlsocbel matt
 VER . SEE . VOIR . SIEHE REF. PG. 186 / 190



25x97 mm
 Ângulo interno e ângulo externo para rodapé curvo 97x297 mm
 Internal angle and external angle for cove base 97x297 mm
 Ángulo interno y ángulo externo para rodapié curvo 97x297 mm
 Angle intérieur et angle extérieur pour plinthe à recouvrement 97x297 mm
 Innenecken und Aussenecken für Hohlkehlsocbel 97x297 mm
 VER . SEE . VOIR . SIEHE REF. PG. 187 / 191



97x297 mm
 Rodapé prensado direito mate . Pressed skirting board matt . Rodapié prensado recto mate
 Plinthe à bord biseauté mat . Sockelleiste matt
 VER . SEE . VOIR . SIEHE REF. PG. 186 / 190



97x297 mm
 Rodapé prensado curvo mate . Pressed cove base sit-in matt
 Rodapié prensado curvo mate . Plinthe à gorge mat . Hohlkehlsocbel matt
 VER . SEE . VOIR . SIEHE REF. PG. 186 / 190



25x97 mm
 Ângulo interno e ângulo externo para rodapé curvo 97x197 mm
 Internal angle and external angle for cove base 97x197 mm
 Ángulo interno y ángulo externo para rodapié curvo 97x197 mm
 Angle intérieur et angle extérieur pour plinthe à gorge 97x197 mm
 Innenecken und Aussenecken für Hohlkehlsocbel 97x197 mm
 VER . SEE . VOIR . SIEHE REF. PG. 187 / 191

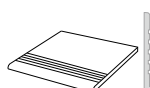

297x297 mm
 Degrau (mate, macio e polido) . Step tread (matt, honed and polished) . Peldaño (mate, macio y pulido)
 Nez de marche (mat, adoucie et poli) . Stufenplatte (matt, weich und poliert)
 VER . SEE . VOIR . SIEHE REF. PG. 187 / 191



uni preto

- PG 452 • mate . mat . matt • R9A • 8,3 mm • U4 P4
- PG 452M • macio . honed . adoucie . weich • 8,3 mm • U4 P4
- PG 452P • polido . polished . pulido . poli . poliert • 7,6 mm • U3 P3
- PGK 452 • mate . mat . matt • R10 • 8,3 mm



uni metal

- PG 24 • mate . mat . matt • R9A • 8,3 mm • U4 P4
- PG 24M • macio . honed . adoucie . weich • 8,3 mm • U4 P4
- PG 24P • polido . polished . pulido . poli . poliert • 7,6 mm • U3 P3
- PGK 24 • mate . mat . matt • R10 • 8,3 mm



uni estanho

- PG 25 • mate . mat . matt • R9A • 8,3 mm • U4 P4
- PG 25M • macio . honed . adoucie . weich • 8,3 mm • U4 P4
- PG 25P • polido . polished . pulido . poli . poliert • 7,6 mm • U3 P3
- PGK 25 • mate . mat . matt • R10 • 8,3 mm



uni zinco

- PG 450 • mate . mat . matt • R9A • 8,3 mm • U4 P4
- PG 450M • macio . honed . adoucie . weich • 8,3 mm • U4 P4
- PG 450P • polido . polished . pulido . poli . poliert • 7,6 mm • U3 P3
- PGK 450 • mate . mat . matt • R10 • 8,3 mm

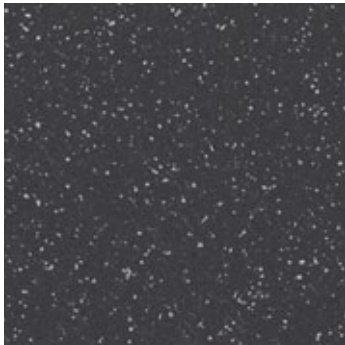

fino preto

- PG 353 • mate . mat . matt • R9A • 8,3 mm • U4 P4
- PG 353P • polido . polished . pulido . poli . poliert • 7,6 mm • U3 P3

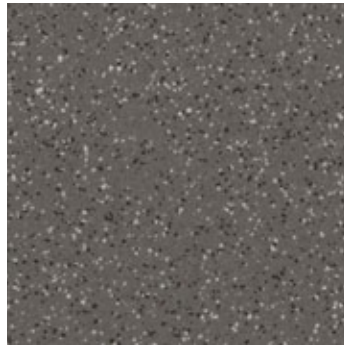

fino metal

- PG 27 • mate . mat . matt • R9A • 8,3 mm • U4 P4
- PG 27P • polido . polished . pulido . poli . poliert • 7,6 mm • U3 P3

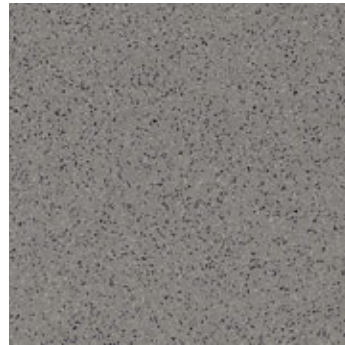

fino estanho

- PG 28 • mate . mat . matt • R9A • 8,3 mm • U4 P4
- PG 28P • polido . polished . pulido . poli . poliert • 7,6 mm • U3 P3

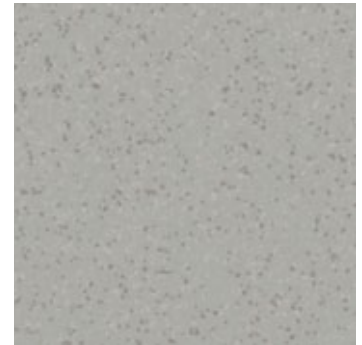

fino zinco

- PG 461 • mate . mat . matt • R9A • 8,3 mm • U4 P4
- PG 461P • polido . polished . pulido . poli . poliert • 7,6 mm • U3 P3

8.3

297x297mm

GRÉS PORCELÂNICO TÉCNICO . HOMOGENEOUS TECHNICAL PORCELAIN TILES

GRÉS PORCELÂNICO TÉCNICO . GRÉS CÉRAME TECHNIQUE . TECHNIK UNGLASIERTES FEINSTEINZEUG



PG29 . FINO PRATA 297x297 mm
PG26E . UNI PRATA 297x297 mm



uni prata

- PG 26 • mate . mat . matt • R9A • 8,3 mm • U4 P4
- PG 26M • macio . honed . adoucie . weich • 8,3 mm • U4 P4
- PG 26P • polido . polished . pulido . poli . poliirt • 7,6 mm • U3 P3
- PGK 26 • mate . mat . matt • R10 • 8,3 mm



uni névoa

- PG 451 • mate . mat . matt • R9A • 8,3 mm • U4 P4
- PG 451M • macio . honed . adoucie . weich • 8,3 mm • U4 P4
- PG 451P • polido . polished . pulido . poli . poliirt • 7,6 mm • U3 P3



uni caqui

- PG 447 • mate . mat . matt • R9A • 8,3 mm • U4 P4
- PG 447M • macio . honed . adoucie . weich • 8,3 mm • U4 P4
- PG 447P • polido . polished . pulido . poli . poliirt • 7,6 mm • U3 P3

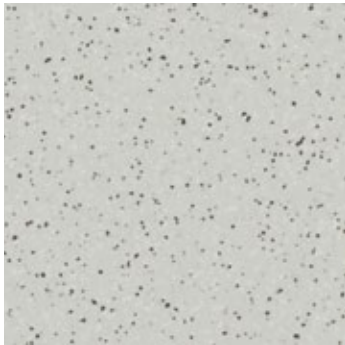

fino prata

- PG 29 • mate . mat . matt • R9A • 8,3 mm • U4 P4
- PG 29P • polido . polished . pulido . poli . poliirt • 7,6 mm • U3 P3



fino névoa

- PG 462 • mate . mat . matt • R9A • 8,3 mm • U4 P4
- PG 462P • polido . polished . pulido . poli . poliirt • 7,6 mm • U3 P3

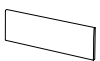

95x297 mm
Rodapé cortado . Cut skirting board rounded edge . Rodapié cortado
Plinthe avec bord arrondi . Sockelleiste mit abgerundeter Kante geschnitten
VER . SEE . VOIR . SIEHE REF. PG. 186-187 / 190-191



97x297 mm
Rodapé prensado curvo mate . Pressed cove base sit-on matt
Rodapié prensado curvo mate . Plinthe à recouvrement mat . Hohlkehlssockel matt
VER . SEE . VOIR . SIEHE REF. PG. 186 / 190



25x97 mm
Ângulo interno e ângulo externo para rodapé curvo 97x297 mm
Internal angle and external angle for cove base 97x297 mm
Angulo interno y angulo externo para rodapié curvo 97x297 mm
Angle intérieur et angle extérieur pour plinthe à recouvrement 97x297 mm
Innenecken und Aussenecken für Hohlkehlssockel 97x297 mm
VER . SEE . VOIR . SIEHE REF. PG. 187 / 191

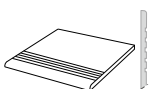

297x297 mm
Degrau (mate, macio e polido) . Step tread (matt, honed and polished) . Peldaño (mate, macio y pulido)
Nez de marche (mat, adoucie et poli) . Stufenplatte (matt, weich und poliirt)
VER . SEE . VOIR . SIEHE REF. PG. 187 / 191



97x297 mm
Rodapé prensado direito mate . Pressed skirting board matt . Rodapié prensado recto mate
Plinthe à bord biseauté mat . Sockelleiste matt
VER . SEE . VOIR . SIEHE REF. PG. 186 / 190



97x297 mm
Rodapé prensado curvo mate . Pressed cove base sit-in matt
Rodapié prensado curvo mate . Plinthe à gorge mat . Hohlkehlssockel matt
VER . SEE . VOIR . SIEHE REF. PG. 186 / 190



25x97 mm
Ângulo interno e ângulo externo para rodapé curvo 97x197 mm
Internal angle and external angle for cove base 97x197 mm
Angulo interno y angulo externo para rodapié curvo 97x197 mm
Angle intérieur et angle extérieur pour plinthe à gorge 97x197 mm
Innenecken und Aussenecken für Hohlkehlssockel 97x197 mm
VER . SEE . VOIR . SIEHE REF. PG. 187 / 191

297x297mm

GRÉS PORCELÂNICO TÉCNICO . HOMOGENEOUS TECHNICAL PORCELAIN TILES

GRÉS PORCELÂNICO TÉCNICO . GRÉS CÉRAME TECHNIQUE . TECHNIK UNGLASIERTES FEINSTEINZEUG



PG3 . UNI GELO 297x297 mm
PG33 . FINO GELO 297x297 mm
PG12 . UNI MOKA 297x297 mm
PG15 . FINO MOKA 297x297 mm
PG499 . UNI PAPAIA 297x297 mm
PG101 . UNI GEMA 297x297 mm
PG6 . UNI MENTA 297x297 mm
PG8 . UNI TURQUESA 297x297 mm

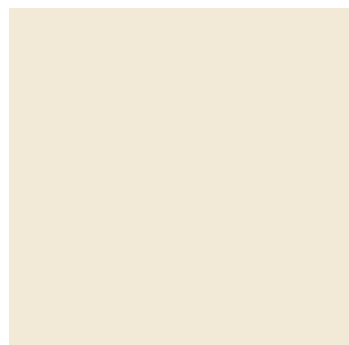

**uni gelo**

- PG 3 • mate . mat . matt • R9A • 8,3 mm • U4 P4
 PG 3M • macio . honed . adoucie . weich • 8,3 mm • U4 P4
 PG 3P • polido . polished . pulido . poli . poliert • 7,6 mm
 • U3 P3
 PGK 3 • mate . mat . matt • R10 • 8,3 mm

**fino gelo**

- PG 33 • mate . mat . matt • R9A • 8,3 mm • U4 P4
 PG 33P • polido . polished . pulido . poli . poliert • 7,6 mm
 • U3 P3

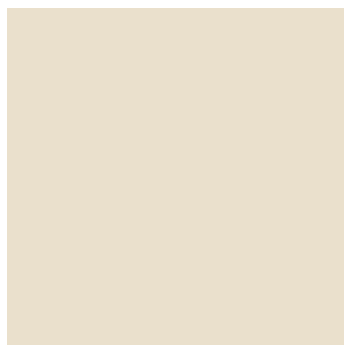
**uni pérola**

- PG 4 • mate . mat . matt • R9A • 8,3 mm • U4 P4
 PG 4M • macio . honed . adoucie . weich • 8,3 mm • U4 P4
 PG 4P • polido . polished . pulido . poli . poliert • 7,6 mm
 • U3 P3
 PGK 4 • mate . mat . matt • R10 • 8,3 mm

**fino pérola**

- PG 355 • mate . mat . matt • R9A • 8,3 mm • U4 P4
 PG 355P • polido . polished . pulido . poli . poliert • 7,6 mm
 • U3 P3

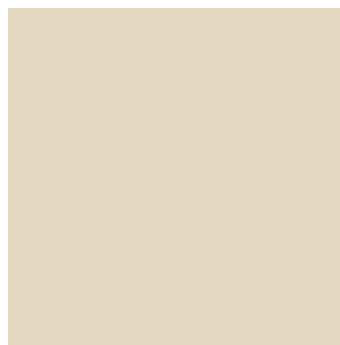
**uni papiro**

- PG 5 • mate . mat . matt • R9A • 8,3 mm • U4 P4
 PG 5M • macio . honed . adoucie . weich • 8,3 mm • U4 P4
 PG 5P • polido . polished . pulido . poli . poliert • 7,6 mm
 • U3 P3
 PGK 5 • mate . mat . matt • R10 • 8,3 mm

**fino papiro**

- PG 335 • mate . mat . matt • R9A • 8,3 mm • U4 P4
 PG 335P • polido . polished . pulido . poli . poliert • 7,6 mm
 • U3 P3

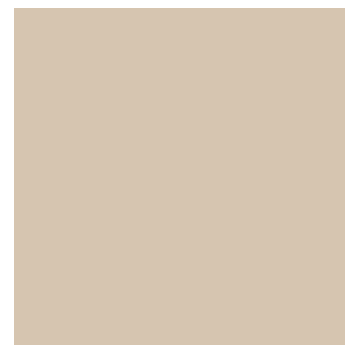
**uni creme**

- PG 544 • mate . mat . matt • R9A • 8,3 mm
 PG 544M • macio . honed . adoucie . weich • 8,3 mm
 PG 544P • polido . polished . pulido . poli . poliert • 7,6 mm
 PGK 544 • mate . mat . matt • R10 • 8,3 mm



95x297 mm

Rodapé cortado . Cut skirting board rounded edge . Rodapié cortado
 Plinthe avec bord arrondi . Sockelleiste mit abgerundeter Kante geschnitten
 VER . SEE . VOIR . SIEHE REF. PG. 186-187 / 190-191



97x297 mm

Rodapé prensado curvo mate . Pressed cove base sit-on matt
 Rodapié prensado curvo mate . Plinthe à recouvrement mat . Hohlkehlsöckel matt
 VER . SEE . VOIR . SIEHE REF. PG. 186 / 190



25x97 mm

Ângulo interno e ângulo externo para rodapé curvo 97x297 mm
 Internal angle and external angle for cove base 97x297 mm
 Ángulo interno y ángulo externo para rodapié curvo 97x297 mm
 Angle intérieur et angle extérieur pour plinthe à recouvrement 97x297 mm
 Innenecken und Aussenecken für Hohlkehlsöckel 97x297 mm
 VER . SEE . VOIR . SIEHE REF. PG. 187 / 191



97x297 mm

Rodapé prensado direito mate . Pressed skirting board matt . Rodapié prensado recto mate
 Plinthe à bord biseauté mat . Sockelleiste matt
 VER . SEE . VOIR . SIEHE REF. PG. 186 / 190



97x297 mm

Rodapé prensado curvo mate . Pressed cove base sit-in matt
 Rodapié prensado curvo mate . Plinthe à gorge mat . Hohlkehlsöckel matt
 VER . SEE . VOIR . SIEHE REF. PG. 186 / 190



25x97 mm

Ângulo interno e ângulo externo para rodapé curvo 97x197 mm
 Internal angle and external angle for cove base 97x197 mm
 Ángulo interno y ángulo externo para rodapié curvo 97x197 mm
 Angle intérieur et angle extérieur pour plinthe à gorge 97x197 mm
 Innenecken und Aussenecken für Hohlkehlsöckel 97x197 mm
 VER . SEE . VOIR . SIEHE REF. PG. 187 / 191

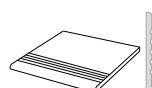

297x297 mm

Desgrau (mate, macio e polido) . Step tread (matt, honed and polished) . Peldaño (mate, macio y pulido)
 Nez de marche (mat, adoucie et poli) . Stufenplatte (matt, weich und poliert)
 VER . SEE . VOIR . SIEHE REF. PG. 187 / 191

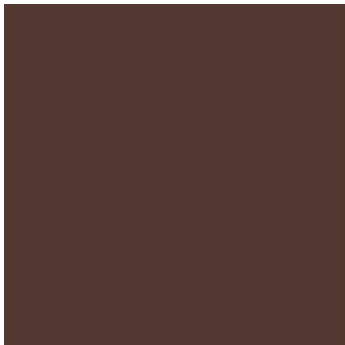

uni chocolate

- PG 14 • mate . mat . matt • R9A • 8,3 mm • U4 P4
- PG 14M • macio . honed . adoucie . weich • 8,3 mm • U4 P4
- PG 14P • polido . polished . pulido . poli . poliert • 7,6 mm • U3 P3

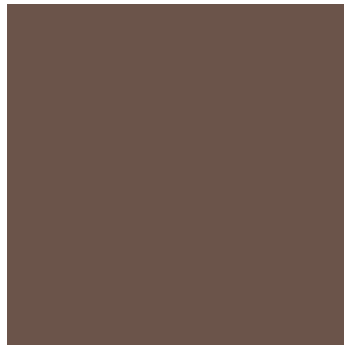

uni cacau

- PG 78 • mate . mat . matt • R9A • 8,3 mm • U4 P4
- PG 78M • macio . honed . adoucie . weich • 8,3 mm • U4 P4
- PG 78P • polido . polished . pulido . poli . poliert • 7,6 mm • U3 P3

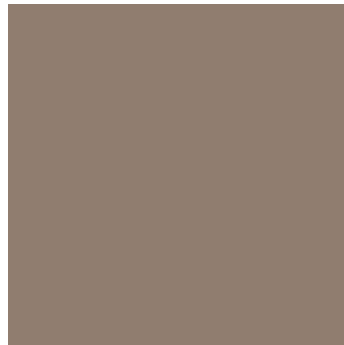

uni moka

- PG 12 • mate . mat . matt • R9A • 8,3 mm • U4 P4
- PG 12M • macio . honed . adoucie . weich • 8,3 mm • U4 P4
- PG 12P • polido . polished . pulido . poli . poliert • 7,6 mm • U3 P3
- PGK 12 • mate . mat . matt • R10 • 8,3 mm



uni capuccino

- PG 453 • mate . mat . matt • R9A • 8,3 mm • U4 P4
- PG 453M • macio . honed . adoucie . weich • 8,3 mm • U4 P4
- PG 453P • polido . polished . pulido . poli . poliert • 7,6 mm • U3 P3



fino cacau

- PG 334 • mate . mat . matt • R9A • 8,3 mm • U4 P4
- PG 334P • polido . polished . pulido . poli . poliert • 7,6 mm • U3 P3



fino moka

- PG 15 • mate . mat . matt • R9A • 8,3 mm • U4 P4
- PG 15P • polido . polished . pulido . poli . poliert • 7,6 mm • U3 P3



fino capuccino

- PG 463 • mate . mat . matt • R9A • 8,3 mm • U4 P4
- PG 463P • polido . polished . pulido . poli . poliert • 7,6 mm • U3 P3

8.3

297x297mm

GRÉS PORCELÂNICO TÉCNICO . HOMOGENEOUS TECHNICAL PORCELAIN TILES

GRÉS PORCELÂNICO TÉCNICO . GRÉS CÉRAME TECHNIQUE . TECHNIK UNGLASIERTES FEINSTEINZEUG



PG74M . UNI OURO 297x297 mm



uni bege

- PG 82 • mate . mat . matt • R9A • 8,3 mm • U4 P4
- PG 82M • macio . honed . adoucie . weich • 8,3 mm • U4 P4
- PG 82P • polido . polished . pulido . poli . poliert • 7,6 mm • U3 P3



uni caramelo

- PG 19 • mate . mat . matt • R9A • 8,3 mm • U4 P4
- PG 19M • macio . honed . adoucie . weich • 8,3 mm • U4 P4
- PG 19P • polido . polished . pulido . poli . poliert • 7,6 mm • U3 P3



uni salmão

- PG 455 • mate . mat . matt • R9A • 8,3 mm • U4 P4
- PG 455M • macio . honed . adoucie . weich • 8,3 mm • U4 P4
- PG 455P • polido . polished . pulido . poli . poliert • 7,6 mm • U3 P3



uni cotto

- PG 454 • mate . mat . matt • R9A • 8,3 mm • U4 P4
- PG 454M • macio . honed . adoucie . weich • 8,3 mm • U4 P4
- PG 454P • polido . polished . pulido . poli . poliert • 7,6 mm • U3 P3



fino bege

- PG 83 • mate . mat . matt • R9A • 8,3 mm • U4 P4
- PG 83P • polido . polished . pulido . poli . poliert • 7,6 mm • U3 P3



uni ouro

- PG 74 • mate . mat . matt • R9A • 8,3 mm • U4 P4
- PG 74M • macio . honed . adoucie . weich • 8,3 mm • U4 P4
- PG 74P • polido . polished . pulido . poli . poliert • 7,6 mm • U3 P3



fino salmão

- PG 464 • mate . mat . matt • R9A • 8,3 mm • U4 P4
- PG 464P • polido . polished . pulido . poli . poliert • 7,6 mm • U3 P3



95x297 mm
Rodapé cortado . Cut skirting board rounded edge . Rodapié cortado
Plinthe avec bord arrondi . Sockelleiste mit abgerundeter Kante geschnitten
VER . SEE . VOIR . SIEHE REF. PG. 186-187 / 190-191



97x297 mm
Rodapé prensado curvo mate . Pressed cove base sit-on matt
Rodapié prensado curvo mate . Plinthe à recouvrement mat . Hohlkehlssockel matt
VER . SEE . VOIR . SIEHE REF. PG. 186 / 190



25x97 mm
Ângulo interno e ângulo externo para rodapé curvo 97x297 mm
Internal angle and external angle for cove base 97x297 mm
Angulo interno y angulo externo para rodapié curvo 97x297 mm
Angle intérieur et angle extérieur pour plinthe à recouvrement 97x297 mm
Innenecken und Aussenecken für Hohlkehlssockel 97x297 mm
VER . SEE . VOIR . SIEHE REF. PG. 187 / 191

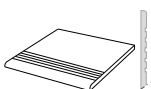

297x297 mm
Degrau (mate, macio e polido) . Step tread (matt, honed and polished) . Peldaño (mate, macio y pulido)
Nez de marche (mat, adoucie et poli) . Stufenplatte (matt, weich und poliert)
VER . SEE . VOIR . SIEHE REF. PG. 187 / 191



97x297 mm
Rodapé prensado direito mate . Pressed skirting board matt . Rodapié prensado recto mate
Plinthe à bord biseauté mat . Sockelleiste matt
VER . SEE . VOIR . SIEHE REF. PG. 186 / 190



97x297 mm
Rodapé prensado curvo mate . Pressed cove base sit-in matt
Rodapié prensado curvo mate . Plinthe à gorge mat . Hohlkehlssockel matt
VER . SEE . VOIR . SIEHE REF. PG. 186 / 190



25x97 mm
Ângulo interno e ângulo externo para rodapé curvo 97x197 mm
Internal angle and external angle for cove base 97x197 mm
Angulo interno y angulo externo para rodapié curvo 97x197 mm
Angle intérieur et angle extérieur pour plinthe à gorge 97x197 mm
Innenecken und Aussenecken für Hohlkehlssockel 97x197 mm
VER . SEE . VOIR . SIEHE REF. PG. 187 / 191

**uni baunilha**

- PG 18 • mate . mat . matt • R9A • 8,3 mm • U4 P4
 PG 18M • macio . honed . adoucie . weich • 8,3 mm • U4 P4
 PG 18P • polido . polished . pulido . poli . poliert • 7,6 mm
 • U3 P3

**uni amêndoa**

- PG 17 • mate . mat . matt • R9A • 8,3 mm • U4 P4
 PG 17M • macio . honed . adoucie . weich • 8,3 mm • U4 P4
 PG 17P • polido . polished . pulido . poli . poliert • 7,6 mm
 • U3 P3

**uni papaia**

- PG 499 • mate . mat . matt • R9A • 8,3 mm • U4 P4
 PG 499M • macio . honed . adoucie . weich • 8,3 mm • U4 P4
 PG 499P • polido . polished . pulido . poli . poliert • 7,6 mm
 • U3 P3

**uni sol**

- PG 70RT • mate . mat . matt • R9A • 8,3 mm • U4 P4
 PG 70M • macio . honed . adoucie . weich • 8,3 mm • U4 P4
 PG 70P • polido . polished . pulido . poli . poliert • 7,6 mm
 • U3 P3

**fino baunilha**

- PG 21 • mate . mat . matt • R9A • 8,3 mm • U4 P4
 PG 21P • polido . polished . pulido . poli . poliert • 7,6 mm
 • U3 P3

**fino amêndoa**

- PG 20 • mate . mat . matt • R9A • 8,3 mm • U4 P4
 PG 20P • polido . polished . pulido . poli . poliert • 7,6 mm
 • U3 P3



95x297 mm

Rodapé cortado . Cut skirting board rounded edge . Rodapié cortado
 Plinthe avec bord arrondi . Sockelleiste mit abgerundeter Kante geschnitten
 VER . SEE . VOIR . SIEHE REF. PG. 186-187 / 190-191



97x297 mm

Rodapé prensado curvo mate . Pressed cove base sit-on matt
 Rodapié prensado curvo mate . Plinthe à recouvrement mat . Hohlkehlsocbel matt
 VER . SEE . VOIR . SIEHE REF. PG. 186 / 190



25x97 mm

Ângulo interno e ângulo externo para rodapé curvo 97x297 mm
 Internal angle and external angle for cove base 97x297 mm
 Ángulo interno y ángulo externo para rodapié curvo 97x297 mm
 Angle intérieur et angle extérieur pour plinthe à recouvrement 97x297 mm
 Innenecken und Aussenecken für Hohlkehlsocbel 97x297 mm
 VER . SEE . VOIR . SIEHE REF. PG. 187 / 191



97x297 mm

Rodapé prensado direito mate . Pressed skirting board matt . Rodapié prensado recto mate
 Plinthe à bord biseauté mat . Sockelleiste matt
 VER . SEE . VOIR . SIEHE REF. PG. 186 / 190



97x297 mm

Rodapé prensado curvo mate . Pressed cove base sit-in matt
 Rodapié prensado curvo mate . Plinthe à gorge mat . Hohlkehlsocbel matt
 VER . SEE . VOIR . SIEHE REF. PG. 186 / 190



25x97 mm

Ângulo interno e ângulo externo para rodapé curvo 97x197 mm
 Internal angle and external angle for cove base 97x197 mm
 Ángulo interno y ángulo externo para rodapié curvo 97x197 mm
 Angle intérieur et angle extérieur pour plinthe à gorge 97x197 mm
 Innenecken und Aussenecken für Hohlkehlsocbel 97x197 mm
 VER . SEE . VOIR . SIEHE REF. PG. 187 / 191

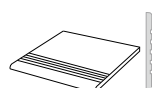

297x297 mm

Desgrau (mate, macio e polido) . Step tread (matt, honed and polished) . Peldaño (mate, macio y pulido)
 Nez de marche (mat, adoucie et poli) . Stufenplatte (matt, weich und poliert)
 VER . SEE . VOIR . SIEHE REF. PG. 187 / 191



PC113 . UNI CRISTAL 97x297 mm
PG70P . UNI SOL 297x297 mm



PG18P . UNI BAUNILHA 297x297 mm

297x297mm

GRÉS PORCELÂNICO TÉCNICO . HOMOGENEOUS TECHNICAL PORCELAIN TILES
GRÉS PORCELÂNICO TÉCNICO . GRÉS CÉRAME TECHNIQUE . TECHNIK UNGLASIERTES FEINSTEINZEUG



PG499P . UNI PAPAIA 297x297 mm
PG499 . UNI PAPAIA 297x297 mm



**uni tangerina**

- PG 69RT • mate . mat . matt • R9A • 8,3 mm • U4 P4
 PG 69M • macio . honed . adoucie . weich • 8,3 mm • U4 P4
 PG 69P • polido . polished . pulido . poli . poliert • 7,6 mm
 • U3 P3

**uni gema**

- PG 101 • mate . mat . matt • R9A • 8,3 mm • U4 P4
 PG 101M • macio . honed . adoucie . weich • 8,3 mm • U4 P4
 PG 101P • polido . polished . pulido . poli . poliert • 7,6 mm
 • U3 P3

**uni lima**

- PG 100 • mate . mat . matt • R9A • 8,3 mm • U4 P4
 PG 100M • macio . honed . adoucie . weich • 8,3 mm • U4 P4
 PG 100P • polido . polished . pulido . poli . poliert • 7,6 mm
 • U3 P3

**uni musgo**

- PG 448 • mate . mat . matt • R9A • 8,3 mm • U4 P4
 PG 448M • macio . honed . adoucie . weich • 8,3 mm • U4 P4
 PG 448P • polido . polished . pulido . poli . poliert • 7,6 mm
 • U3 P3



95x297 mm

Rodapé cortado . Cut skirting board rounded edge . Rodapié cortado
 Plinthe avec bord arrondi . Sockelleiste mit abgerundeter Kante geschnitten
 VER . SEE . VOIR . SIEHE REF. PG. 186-187



97x297 mm

Rodapé prensado curvo mate . Pressed cove base sit-in matt
 Rodapié prensado curvo mate . Plinthe à recouvrement mat . Hohlkehlsöckel matt
 VER . SEE . VOIR . SIEHE REF. PG. 186



25x97 mm

Ângulo interno e ângulo externo para rodapé curvo 97x297 mm
 Internal angle and external angle for cove base 97x297 mm
 Ángulo interno y ángulo externo para rodapié curvo 97x297 mm
 Angle intérieur et angle extérieur pour plinthe à recouvrement 97x297 mm
 Innenecken und Aussenecken für Hohlkehlsöckel 97x297 mm
 VER . SEE . VOIR . SIEHE REF. PG. 187



97x297 mm

Rodapé prensado direito mate . Pressed skirting board matt . Rodapié prensado recto mate
 Plinthe à bord biseauté mat . Sockelleiste matt
 VER . SEE . VOIR . SIEHE REF. PG. 186



97x297 mm

Rodapé prensado curvo mate . Pressed cove base sit-in matt
 Rodapié prensado curvo mate . Plinthe à gorge mat . Hohlkehlsöckel matt
 VER . SEE . VOIR . SIEHE REF. PG. 186



25x97 mm

Ângulo interno e ângulo externo para rodapé curvo 97x197 mm
 Internal angle and external angle for cove base 97x197 mm
 Ángulo interno y ángulo externo para rodapié curvo 97x197 mm
 Angle intérieur et angle extérieur pour plinthe à gorge 97x197 mm
 Innenecken und Aussenecken für Hohlkehlsöckel 97x197 mm
 VER . SEE . VOIR . SIEHE REF. PG. 187

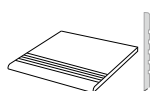

297x297 mm

Desgrau (mate, macio e polido) . Step tread (matt, honed and polished) . Peldaño (mate, macio y pulido)
 Nez de marche (mat, adoucie et poli) . Stufenplatte (matt, weich und poliert)
 VER . SEE . VOIR . SIEHE REF. PG. 187



PG499P . UNI PAPAIA 297x297 mm
PG499 . UNI PAPAIA 297x297 mm



PG448P . UNI MUSGO 297x297 mm
PG100P . UNI LIMA 297x297 mm
PG25 . UNI ESTANHO 297x297mm

8.3

297x297mm

GRÉS PORCELÂNICO TÉCNICO . HOMOGENEOUS TECHNICAL PORCELAIN TILES

GRÉS PORCELÂNICO TÉCNICO . GRÉS CÉRAME TECHNIQUE . TECHNIK UNGLASIERTES FEINSTEINZEUG



uni limonete

PG 445 • mate . mat . matt • R9A • 8,3 mm • U4 P4

PG 445M • macio . honed . adoucie . weich • 8,3 mm • U4 P4

PG 445P • polido . polished . pulido . poli . poliert • 7,6 mm
• U3 P3

PG265 . UNI GELO 297x597
PG446 . UNI TREVO 297x297
PG445 . UNI LIMONETE 297x297



uni trevo

- PG 446 • mate . mat . matt • R9A • 8,3 mm • U4 P4
- PG 446M • macio . honed . adoucie . weich • 8,3 mm • U4 P4
- PG 446P • polido . polished . pulido . poli . poliert • 7,6 mm • U3 P3



uni menta

- PG 6 • mate . mat . matt • R9A • 8,3 mm • U4 P4
- PG 6M • macio . honed . adoucie . weich • 8,3 mm • U4 P4
- PG 6P • polido . polished . pulido . poli . poliert • 7,6 mm • U3 P3

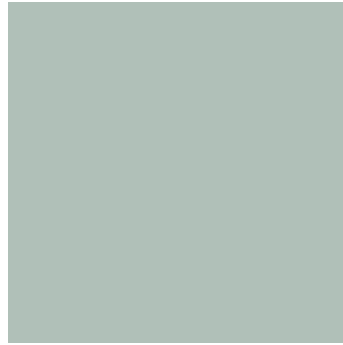

uni turquesa

- PG 8 • mate . mat . matt • R9A • 8,3 mm • U4 P4
- PG 8M • macio . honed . adoucie . weich • 8,3 mm • U4 P4
- PG 8P • polido . polished . pulido . poli . poliert • 7,6 mm • U3 P3



uni tropical

- PG 439RT • mate . mat . matt • R9A • 8,3 mm • U4 P4
- PG 439M • macio . honed . adoucie . weich • 8,3 mm
- PG 439P • polido . polished . pulido . poli . poliert • 7,6 mm • U3 P3

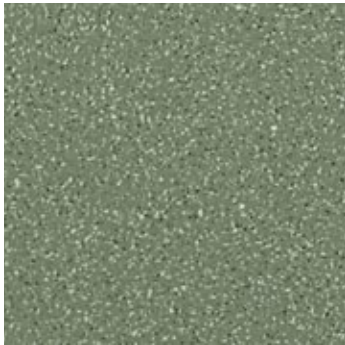

fino trevo

- PG 460 • mate . mat . matt • R9A • 8,3 mm • U4 P4
- PG 460P • polido . polished . pulido . poli . poliert • 7,6 mm • U3 P3



fino turquesa

- PG 10 • mate . mat . matt • R9A • 8,3 mm • U4 P4
- PG 10P • polido . polished . pulido . poli . poliert • 7,6 mm • U3 P3



95x297 mm
Rodapé cortado . Cut skirting board rounded edge . Rodapié cortado
Plinthe avec bord arrondi . Sockelleiste mit abgerundeter Kante geschnitten
VER . SEE . VOIR . SIEHE REF. PG. 186-187 / 190-191



97x297 mm
Rodapé prensado curvo mate . Pressed cove base sit-on matt
Rodapié prensado curvo mate . Plinthe à recouvrement mat . Hohlkehlssockel matt
VER . SEE . VOIR . SIEHE REF. PG. 186 / 190



25x97 mm
Ângulo interno e ângulo externo para rodapé curvo 97x297 mm
Internal angle and external angle for cove base 97x297 mm
Angulo interno y angulo externo para rodapié curvo 97x297 mm
Angle intérieur et angle extérieur pour plinthe à recouvrement 97x297 mm
Innenecken und Aussenecken für Hohlkehlssockel 97x297 mm
VER . SEE . VOIR . SIEHE REF. PG. 187 / 191

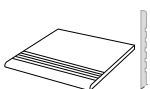

297x297 mm
Degrau (mate, macio e polido) . Step tread (matt, honed and polished) . Peldaño (mate, macio y pulido)
Nez de marche (mat, adoucie et poli) . Stufenplatte (matt, weich und poliert)
VER . SEE . VOIR . SIEHE REF. PG. 187 / 191



97x297 mm
Rodapé prensado direito mate . Pressed skirting board matt . Rodapié prensado recto mate
Plinthe à bord biseauté mat . Sockelleiste matt
VER . SEE . VOIR . SIEHE REF. PG. 186 / 190



97x297 mm
Rodapé prensado curvo mate . Pressed cove base sit-in matt
Rodapié prensado curvo mate . Plinthe à gorge mat . Hohlkehlssockel matt
VER . SEE . VOIR . SIEHE REF. PG. 186 / 190



25x97 mm
Ângulo interno e ângulo externo para rodapé curvo 97x197 mm
Internal angle and external angle for cove base 97x197 mm
Angulo interno y angulo externo para rodapié curvo 97x197 mm
Angle intérieur et angle extérieur pour plinthe à gorge 97x197 mm
Innenecken und Aussenecken für Hohlkehlssockel 97x197 mm
VER . SEE . VOIR . SIEHE REF. PG. 187 / 191

297x297mm

GRÉS PORCELÂNICO TÉCNICO . HOMOGENEOUS TECHNICAL PORCELAIN TILES

GRÉS PORCELÂNICO TÉCNICO . GRÉS CÉRAME TECHNIQUE . TECHNIK UNGLASIERTES FEINSTEINZEUG



INSTITUTO CUF - PORTUGAL
PG8 . UNI TURQUESA 297x297 mm
PG10 . FINO TURQUESA 297x297 mm



297x297mm

GRÉS PORCELÂNICO TÉCNICO . HOMOGENEOUS TECHNICAL PORCELAIN TILES

GRÉS PORCELÂNICO TÉCNICO . GRÉS CÉRAME TECHNIQUE . TECHNIK UNGLASIERTES FEINSTEINZEUG



PG39 . FINO CÉU 297x297 mm
PG36 . UNI CÉU 297x297 mm
PG35 . UNI LAGO 297x297 mm
PG3 . UNI GELO 297x297 mm
PG24036 . UNI CÉU 297x297 mm (22x47 mm)
PG39P . FINO CÉU 297x297 mm



PG35P . UNI LAGO 297x297 mm
PG92P . UNI CRISTAL 297x297 mm
PG38 . UNI ÁGUA 297x297 mm
PG38D . UNI ÁGUA 297x297 mm

**uni mineral**

- PG 444 • mate . mat . matt • R9A • 8,3 mm • U4 P4
 PG 444M • macio . honed . adoucie . weich • 8,3 mm • U4 P4
 PG 444P • polido . polished . pulido . poli . poliert • 7,6 mm
 • U3 P3

**uni céu**

- PG 36 • mate . mat . matt • R9A • 8,3 mm • U4 P4
 PG 36M • macio . honed . adoucie . weich • 8,3 mm • U4 P4
 PG 36P • polido . polished . pulido . poli . poliert • 7,6 mm
 • U3 P3

**uni lago**

- PG 35 • mate . mat . matt • R9A • 8,3 mm • U4 P4
 PG 35M • macio . honed . adoucie . weich • 8,3 mm • U4 P4
 PG 35P • polido . polished . pulido . poli . poliert • 7,6 mm
 • U3 P3

**uni água**

- PG 38 • mate . mat . matt • R9A • 8,3 mm • U4 P4
 PG 38M • macio . honed . adoucie . weich • 8,3 mm • U4 P4
 PG 38P • polido . polished . pulido . poli . poliert • 7,6 mm
 • U3 P3

**fino mineral**

- PG 459 • mate . mat . matt • R9A • 8,3 mm • U4 P4
 PG 459P • polido . polished . pulido . poli . poliert • 7,6 mm
 • U3 P3

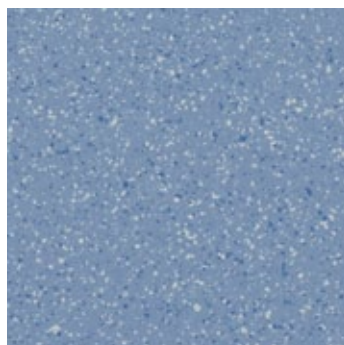
**fino céu**

- PG 39 • mate . mat . matt • R9A • 8,3 mm • U4 P4
 PG 39P • polido . polished . pulido . poli . poliert • 7,6 mm
 • U3 P3

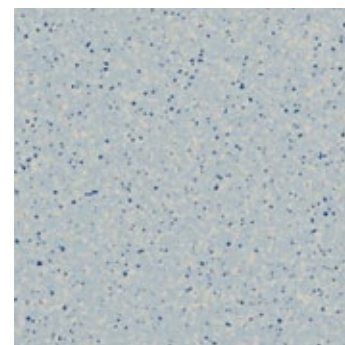
**fino água**

- PG 41 • mate . mat . matt • R9A • 8,3 mm • U4 P4
 PG 41P • polido . polished . pulido . poli . poliert • 7,6 mm
 • U3 P3



95x297 mm

Rodapé cortado . Cut skirting board rounded edge . Rodapié cortado
 Plinthe avec bord arrondi . Sockelleiste mit abgerundeter Kante geschnitten

VER . SEE . VOIR . SIEHE REF. PG. 186-187 / 190-191



97x297 mm

Rodapé prensado curvo mate . Pressed cove base sit-on matt
 Rodapié prensado curvo mate . Plinthe à recouvrement mat . Hohlkehlsoclel matt

VER . SEE . VOIR . SIEHE REF. PG. 186 / 190



25x97 mm

Ângulo interno e ângulo externo para rodapé curvo 97x297 mm
 Internal angle and external angle for cove base 97x297 mm
 Ángulo interno y ángulo externo para rodapié curvo 97x297 mm
 Angle intérieur et angle extérieur pour plinthe à recouvrement 97x297 mm
 Innenecken und Aussenecken für Hohlkehlsoclel 97x297 mm

VER . SEE . VOIR . SIEHE REF. PG. 187 / 191



97x297 mm

Rodapé prensado direito mate . Pressed skirting board matt . Rodapié prensado recto mate
 Plinthe à bord biseauté mat . Sockelleiste matt

VER . SEE . VOIR . SIEHE REF. PG. 186 / 190



97x297 mm

Rodapé prensado curvo mate . Pressed cove base sit-in matt
 Rodapié prensado curvo mate . Plinthe à gorge mat . Hohlkehlsoclel matt

VER . SEE . VOIR . SIEHE REF. PG. 186 / 190



25x97 mm

Ângulo interno e ângulo externo para rodapé curvo 97x197 mm
 Internal angle and external angle for cove base 97x197 mm
 Ángulo interno y ángulo externo para rodapié curvo 97x197 mm
 Angle intérieur et angle extérieur pour plinthe à gorge 97x197 mm
 Innenecken und Aussenecken für Hohlkehlsoclel 97x197 mm

VER . SEE . VOIR . SIEHE REF. PG. 187 / 191

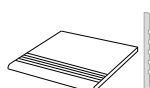

297x297 mm

Desgrau (mate, macio e polido) . Step tread (matt, honed and polished) . Peldaño (mate, macio y pulido)
 Nez de marche (mat, adoucie et poli) . Stufenplatte (matt, weich und poliert)

VER . SEE . VOIR . SIEHE REF. PG. 187 / 191



uni lavanda

- PG 354 • mate . mat . matt • R9A • 8,3 mm • U4 P4
- PG 354M • macio . honed . adoucie . weich • 8,3 mm • U4 P4
- PG 354P • polido . polished . pulido . poli . poliert • 7,6 mm • U3 P3

uni indigo

- PG 438RT • mate . mat . matt • R9A • 8,3 mm • U4 P4
- PG 438M • macio . honed . adoucie . weich • 8,3 mm
- PG 438P • polido . polished . pulido . poli . poliert • 7,6 mm



- PG438RT . UNI INDIGO 297x297 mm
- PG69RT . UNI TANGERINA 297x297 mm
- PG448 . UNI MUSGO 297x297 mm
- PG100 . UNI LIMA 297x297 mm
- PG439RT . UNI TROPICAL 297x297 mm
- PG92RT . UNI CRISTAL 297x297 mm
- PG70RT . UNI SOL 297x297 mm

297x297mm

GRÉS PORCELÂNICO TÉCNICO . HOMOGENEOUS TECHNICAL PORCELAIN TILES

GRÉS PORCELÂNICO TÉCNICO . GRÉS CÉRAME TECHNIQUE . TECHNIK UNGLASIERTES FEINSTEINZEUG



PG438RT . UNI INDIGO 297x297 mm



297x297mm

GRÉS PORCELÂNICO TÉCNICO . HOMOGENEOUS TECHNICAL PORCELAIN TILES

GRÉS PORCELÂNICO TÉCNICO . GRÉS CÉRAME TECHNIQUE . TECHNIK UNGLASIERTES FEINSTEINZEUG



PG23004 . UNI LIMA+UNI METAL 297x297 mm (\approx 22x22 mm)
PG22100 . UNI LIMA 297x297 mm (\approx 22x22 mm)
PPI89 . UNI METAL 97x97 mm

297x297mm PORCELAIN MOSAIC ≈ 19x19 mm

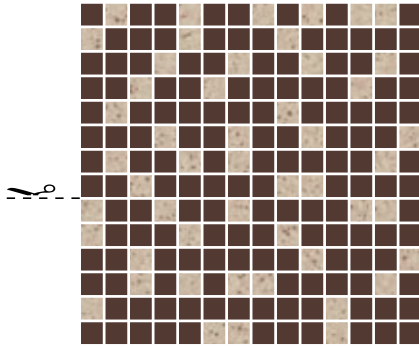

PG19001 • uni chocolate + fino bege
mate . mat . matt

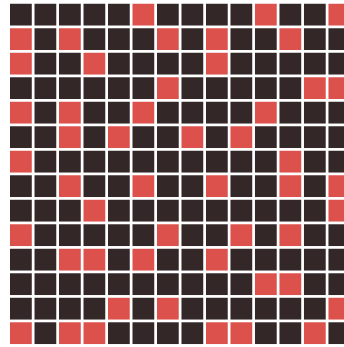

PG19002 • uni carvão + uni papoila
mate . mat . matt

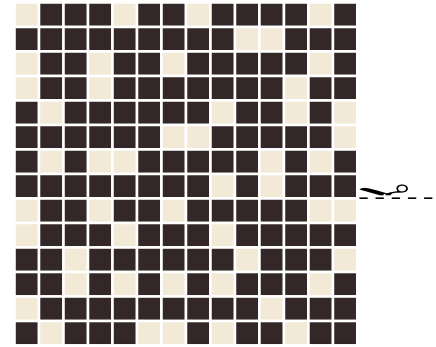

PG19003 • uni carvão + uni gelo
mate . mat . matt

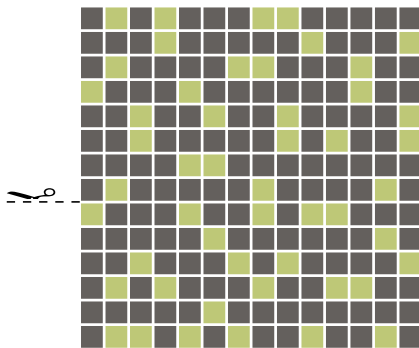

PG19004 • uni metal + uni lima
mate . mat . matt

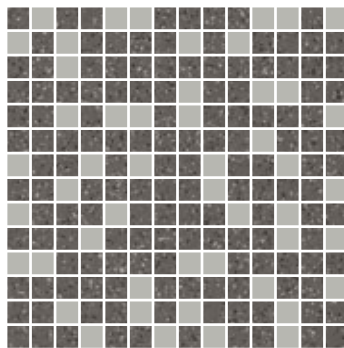

PG19005 • fino metal + uni prata
mate . mat . matt

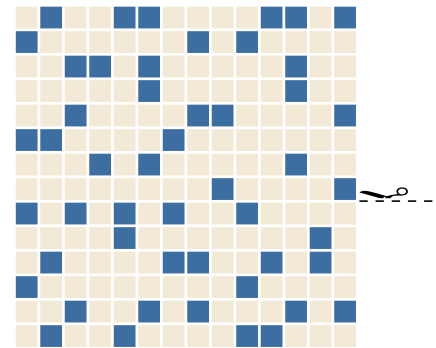

PG19006 • uni gelo + uni lago
mate . mat . matt

297x297mm PORCELAIN MOSAIC ≈ 22x22 mm

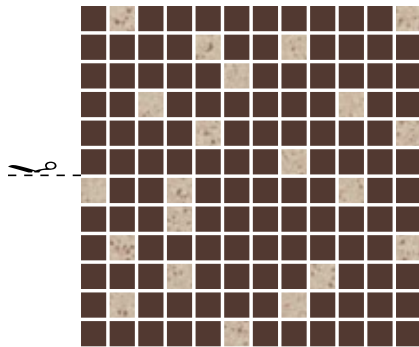

PG23001 • uni chocolate + fino bege
mate . mat . matt



PG23002 • uni carvão + uni papoila
mate . mat . matt

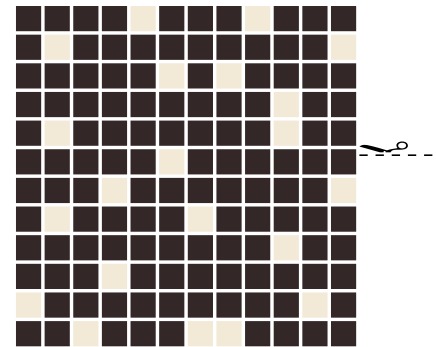

PG23003 • uni carvão + uni gelo
mate . mat . matt

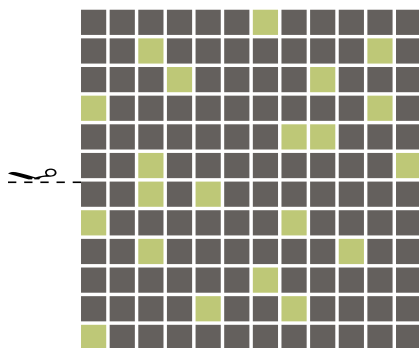

PG23004 • uni metal + uni lima
mate . mat . matt

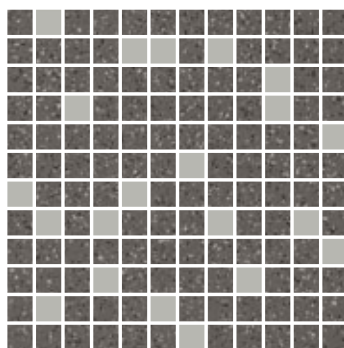

PG23005 • fino metal + uni prata
mate . mat . matt

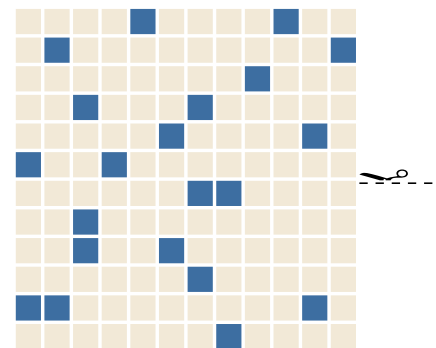

PG23006 • uni gelo + uni lago
mate . mat . matt

Outras composições sob consulta. • Other compositions available under inquiry. • Otras composiciones, sobre consulta.
D'autres compositions disponibles sous demande. • Andere Kombinationen auf Anfrage.

297x297mm

GRÉS PORCELÂNICO TÉCNICO . HOMOGENEOUS TECHNICAL PORCELAIN TILES
GRÉS PORCELÂNICO TÉCNICO . GRÉS CÉRAME TECHNIQUE . TECHNIK UNGLASIERTES FEINSTEINZEUG



297x297mm PORCELAIN MOSAIC ≈ 22x22 mm

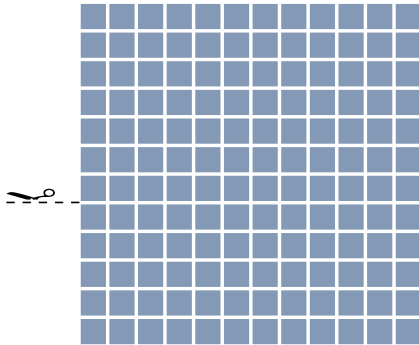

PG22036 • **uni céu**
mate . mat . matt

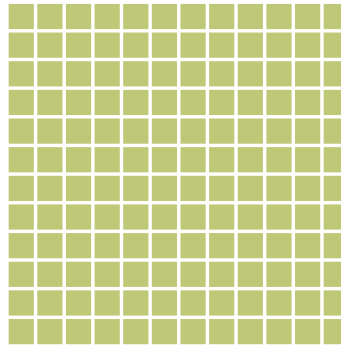

PG22100 • **uni lima**
mate . mat . matt

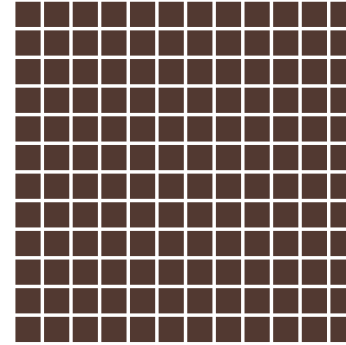

PG22014 • **uni chocolate**
mate . mat . matt

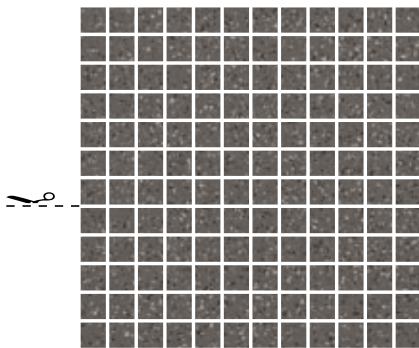

PG22027 • **fino metal**
mate . mat . matt

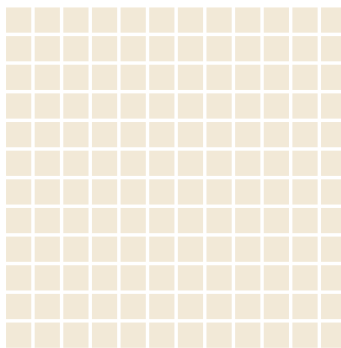

PG22003 • **uni gelo**
mate . mat . matt

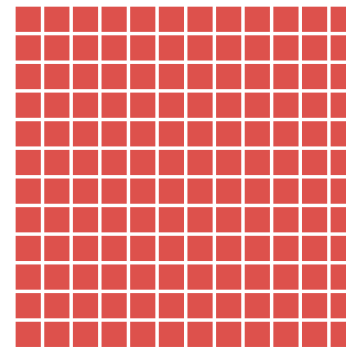

PG22068 • **uni papoila**
mate . mat . matt

297x297mm PORCELAIN MOSAIC ≈ 22x47 mm

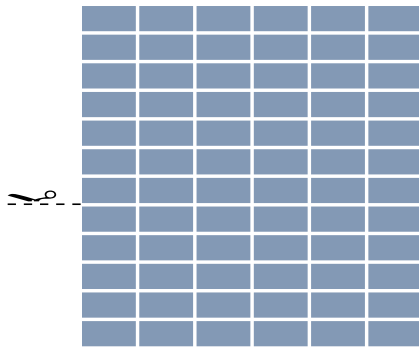

PG24036 • **uni céu**
mate . mat . matt

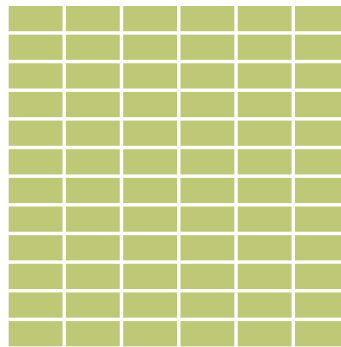

PG24100 • **uni lima**
mate . mat . matt

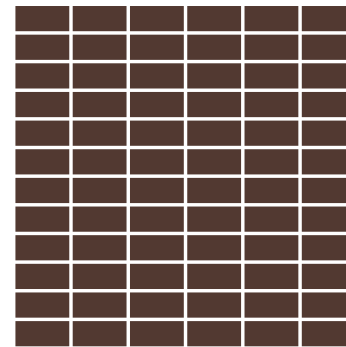

PG24014 • **uni chocolate**
mate . mat . matt

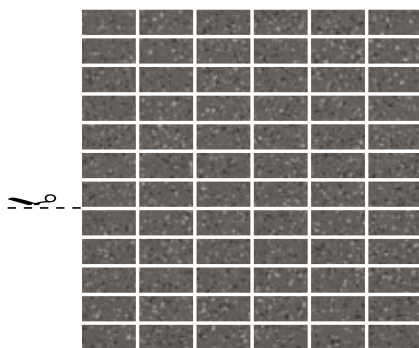

PG24027 • **fino metal**
mate . mat . matt

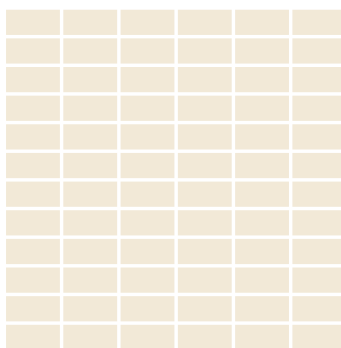

PG24003 • **uni gelo**
mate . mat . matt

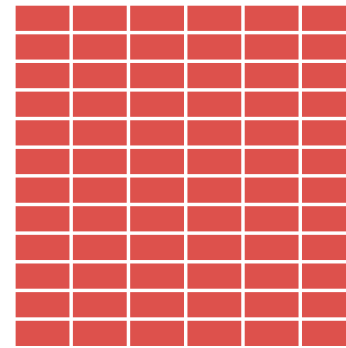

PG24068 • **uni papoila**
mate . mat . matt

Outras composições sob consulta . • Other compositions available under inquiry . • Otras composiciones, sobre consulta.
D'autres compositions disponibles sous demande . • Andere Kombinationen auf Anfrage.

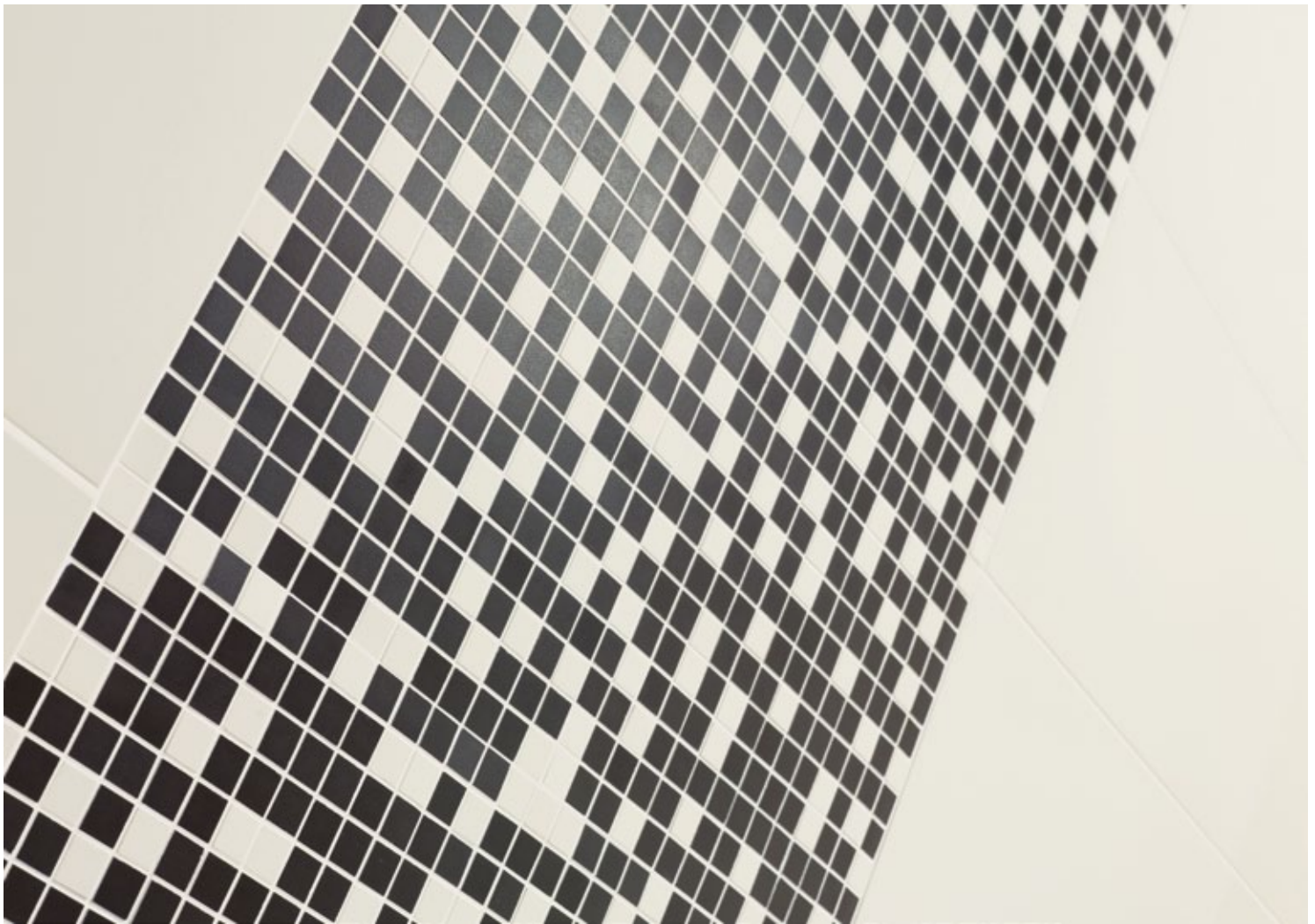

PG19003 . UNI CARVÃO+UNI GELO 297x297 mm (≈19x19 mm)

297x297mm PORCELAIN MOSAIC ≈ 47x47 mm

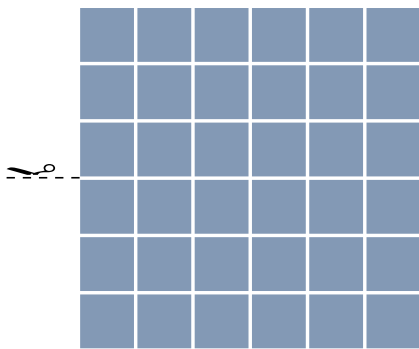

PG47036 • **uni céu**
mate . mat . matt

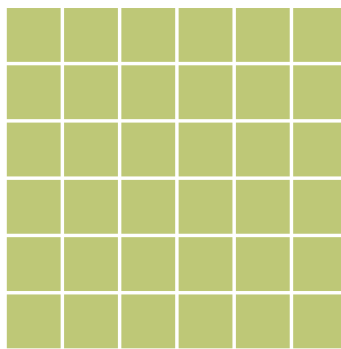

PG47100 • **uni lima**
mate . mat . matt

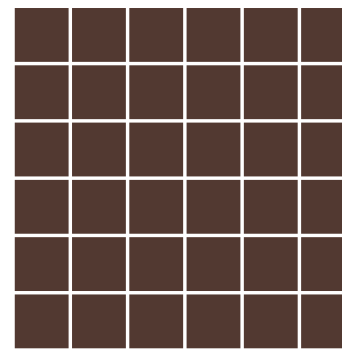

PG47014 • **uni chocolate**
mate . mat . matt

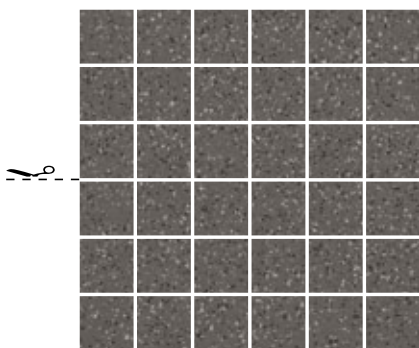

PG47027 • **fino metal**
mate . mat . matt

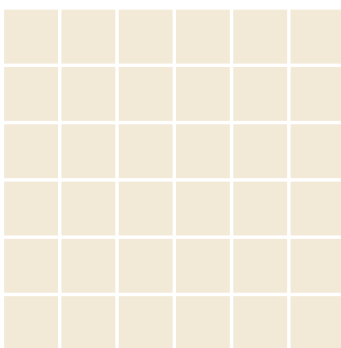

PG47003 • **uni gelo**
mate . mat . matt

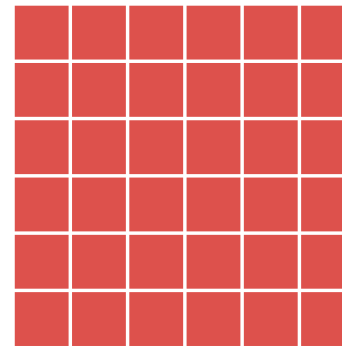

PG47068 • **uni papoila**
mate . mat . matt

Outras composições sob consulta. • Other compositions available under inquiry. • Otras composiciones, sobre consulta.
D'autres compositions disponibles sous demande. • Andere Kombinationen auf Anfrage.

297x297mm

GRÉS VIDRADO . GLAZED VITRIFIED TILES
GRÉS VIDRIADO . GRÉS ÉMAILLÉ . GLASIERTES STEINZEUG



PC323 . UNI PAPAIA 197x597 mm
PC329 . UNI GELO 197x597 mm
PP3 . UNI GELO 297x297 mm



7,2

297x297mmGRÉS VIDRADO . GLAZED VITRIFIED TILES
GRÉS VIDRIADO . GRÉS ÉMAILLÉ . GLASIERTES STEINZEUG

PP 441 • **uni cereja**
mate . mat . matt • 7,2 mm
II / U2



PP 68 • **uni papoila**
mate . mat . matt • 7,2 mm
II / U2

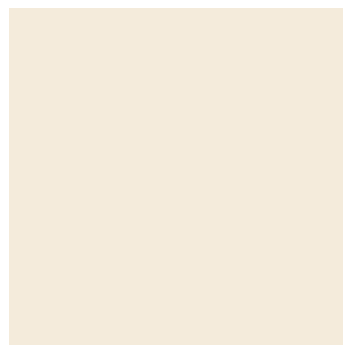

PP 67 • **uni pergamon**
mate . mat . matt • 7,2 mm
IV / U3

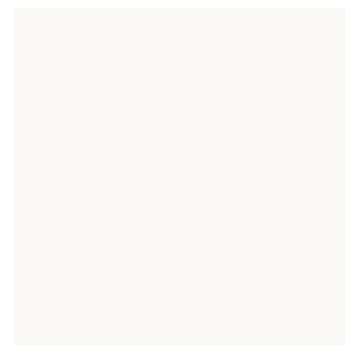

PP 92 • **uni cristal**
mate . mat . matt • 7,2 mm
IV / U3

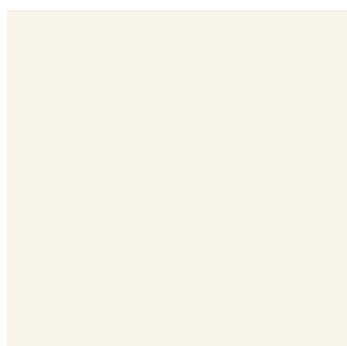

PP 3 • **uni gelo**
mate . mat . matt • 7,2 mm
IV / U3

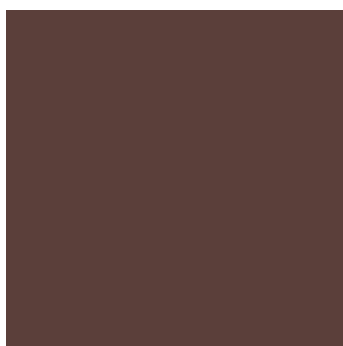

PP 14 • **uni chocolate**
mate . mat . matt • 7,2 mm
I

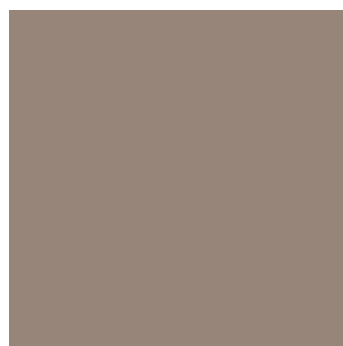

PP 12 • **uni moka**
mate . mat . matt • 7,2 mm
II / U2



PP 18 • **uni baunilha**
mate . mat . matt • 7,2 mm
III / U2S



PP 440 • **uni maçã**
mate . mat . matt • 7,2 mm
IV / U3

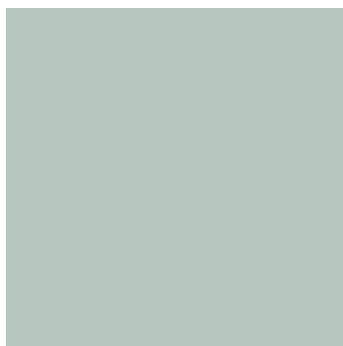

PP 8 • **uni turquesa**
mate . mat . matt • 7,2 mm
IV / U3



PP 439 • **uni tropical**
mate . mat . matt • 7,2 mm
II / U2



PP 36 • **uni céu**
mate . mat . matt • 7,2 mm
II / U2



PP 35 • **uni lago**
mate . mat . matt • 7,2 mm
II / U2



PP 438 • **uni indigo**
mate . mat . matt • 7,2 mm
II / U2

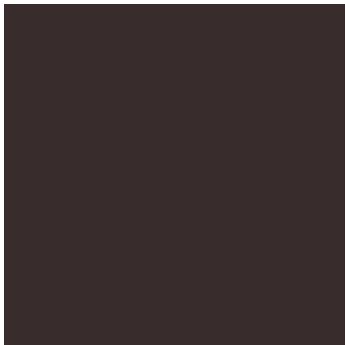

PP 23 • **uni carvão**
mate . mat . matt • 7,2 mm
I



PP 24 • **uni metal**
mate . mat . matt • 7,2 mm
I



PP 25 • **uni estanho**
mate . mat . matt • 7,2 mm
II / U2

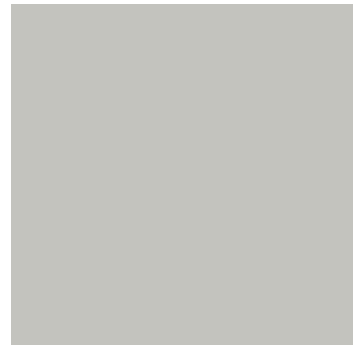

PP 26 • **uni prata**
mate . mat . matt • 7,2 mm
IV / U3



PP 293 • **uni meloa**
mate . mat . matt • 7,2 mm
III / U2S



PP 69 • **uni tangerina**
mate . mat . matt • 7,2 mm
II / U2



PP 101 • **uni gema**
mate . mat . matt • 7,2 mm
III / U2S



PP 100 • **uni lima**
mate . mat . matt • 7,2 mm
III / U2S



PP69 . UNI TANGERINA 297x297 mm



97

X2097



PAVIMENTO / REVESTIMENTO
FLOOR / WALL TILES
PAVIMENTO / REVESTIMIENTO
REVÊTEMENT DE SOLS / DE MURS
BODENFLIESEN / WANDFLIESEN

MATE
MATT
MATE
MAT
MATT

GRÉS PORCELÂNICO TÉCNICO
HOMOGENEOUS TECHNICAL PORCELAIN TILES
GRÉS PORCELÂNICO TÉCNICO
GRÉS CÉRAME TECHNIQUE
TECHNIK UNGLASIERTES FEINSTEINZEUG

GRÉS VIDRADO
GLAZED VITRIFIED TILES
GRÉS VIDRIADO
GRÉS ÉMAILLÉ
GLASIERTES STEINZEUG



REVESTIMENTO
WALL
REVESTIMIENTO
FAÏENCE
WANDFLIESEN

BRILHO
GLOSSY
BRILLANTE
BRILLANTE
GLÄNZENDE

REVESTIMENTO UNICOLOR BRILHANTE
UNI GLOSSY WALL TILE
REVESTIMIENTO UNICOLOR BRILLANTE
FAÏENCE UNI BRILLANTE
GLÄNZENDE STEINGUT WANDFLIESEN UNI

8.3

97x297mm

GRÉS PORCELÂNICO TÉCNICO . HOMOGENEOUS TECHNICAL PORCELAIN TILES

GRÉS PORCELÂNICO TÉCNICO . GRÉS CÉRAME TECHNIQUE . TECHNIK UNGLASIERTES FEINSTEINZEUG



PG88 . UNI GELO 97x297 mm
PG86 . UNI ESTANHO 97x297 mm
PG87 . UNI PRATA 97x297 mm
PG90 . UNI BAUNILHA 97x297 mm
PG3 . UNI GELO 297x297 mm

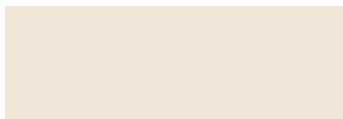

PG 91 • uni pergamon
mate . mat . matt • R9A • 8,3 mm
U4 P3

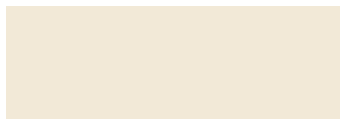

PG 88 • uni gelo
mate . mat . matt • R9A • 8,3 mm
U4 P3



PG 85 • uni carvão
mate . mat . matt • R9A • 8,3 mm
U4 P3



PG 305 • uni pérola
mate . mat . matt • R9A • 8,3 mm



PG 86 • uni estanho
mate . mat . matt • R9A • 8,3 mm
U4 P3



PG 89 • uni moka
mate . mat . matt • R9A • 8,3 mm
U4 P3



PG 87 • uni prata
mate . mat . matt • R9A • 8,3 mm
U4 P3



PG 90 • uni baunilha
mate . mat . matt • R9A • 8,3 mm
U4 P3

97x297mm

GRÉS VIDRADO . GLAZED VITRIFIED TILES
GRÉS VIDRIADO . GRÈS ÉMAILLÉ . GLASIERTES STEINZEUG



PP392 . UNI CEREJA 97x297 mm
PP225 . UNI METAL 97x297 mm
PG268P . UNI METAL 297x597
PG450 . UNI ZINCO 297x297 mm



Campagnolo

FSA
FULL SPEED AHEAD

SHIMANO

ALLU TIME fi'zi:k

MAVIC american

dedb EASTON

97x297mm

GRÉS VIDRADO . GLAZED VITRIFIED TILES
GRÉS VIDRIADO . GRÈS ÉMAILLÉ . GLASIERTES STEINZEUG



PP88 . UNI GELO 97x297 mm
PP140 . UNI LIMA 97x97 mm
PP141 . UNI GEMA 97x97 mm
PP253 . UNI PAPAÏLA 97x97 mm
PP156 . UNI PAPAÏA 97x97 mm
PP157 . UNI MELOA 97x97 mm
PP239 . UNI TANGERINA 97x97 mm
PP3 . UNI GELO 297x297 mm



97x297mm

GRÉS VIDRADO . GLAZED VITRIFIED TILES
GRÉS VIDRIADO . GRÈS ÉMAILLÉ . GLASIERTES STEINZEUG



PP89 . UNI MOKA 97x297 mm
PP91 . UNI PERGAMON 97x297 mm
PG18U . UNI BAUNILHA 297x297 mm
PG12 . UNI MOKA 297x297 mm

care for environment because
CARE FOR TOMORROW !



7.2

97x297mm

GRÉS VIDRADO . GLAZED VITRIFIED TILES
GRÉS VIDRIADO . GRÈS ÉMAILLÉ . GLASIERTES STEINZEUG



PP222 . UNI MELOA 97x297 mm



PP 392 • **uni cereja**
mate . mat . matt • 7,2 mm
II



PP 86 • **uni estanho**
mate . mat . matt • 7,2 mm
II / U2



PP 224 • **uni tangerina**
mate . mat . matt • 7,2 mm
II / U2



PP 393 • **uni papoila**
mate . mat . matt • 7,2 mm
II / U2



PP 87 • **uni prata**
mate . mat . matt • 7,2 mm
IV / U3



PP 312 • **uni gema**
mate . mat . matt • 7,2 mm
III / U2S

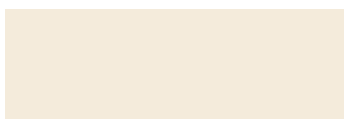

PP 91 • **uni pergamon**
mate . mat . matt • 7,2 mm
IV / U3

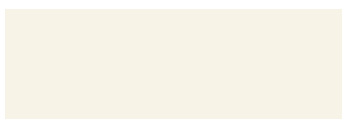

PP 88 • **uni gelo**
mate . mat . matt • 7,2 mm
IV / U3



PP 223 • **uni lima**
mate . mat . matt • 7,2 mm
III / U2S

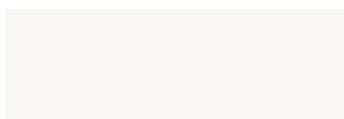

PP 113 • **uni cristal**
mate . mat . matt • 7,2 mm
IV / U3



PP 89 • **uni moka**
mate . mat . matt • 7,2 mm
II / U2



PP 391 • **uni tropical**
mate . mat . matt • 7,2 mm
II



PP 85 • **uni carvão**
mate . mat . matt • 7,2 mm
I



PP 90 • **uni baunilha**
mate . mat . matt • 7,2 mm
III / U2S



PP 388 • **uni céu**
mate . mat . matt • 7,2 mm
II / U2



PP 225 • **uni metal**
mate . mat . matt • 7,2 mm
I



PP 222 • **uni meloa**
mate . mat . matt • 7,2 mm
III / U2S



PP 390 • **uni indigo**
mate . mat . matt • 7,2 mm
II

97x297mm

REVESTIMENTO UNICOLOR BRILHANTE . UNI GLOSSY WALL TILE

REVESTIMIENTO UNICOLOR BRILLANTE . FAÏENCE UNI BRILLANTE . GLÄNZENDE STEINGUT WANDFLIESEN UNI



PC85 / PP85 . UNI CARVÃO 97x297 mm
PC86 / PP86 . UNI ESTANHO 97x297 mm
PC87 / PP87 . UNI PRATA 97x297 mm
PC88 / PP88 . UNI GELO 97x297 mm
PG23P . UNI CARVÃO 297x297 mm
PG3P . UNI GELO 297x297 mm



8.3

97x297mm

REVESTIMENTO UNICOLOR BRILHANTE . UNI GLOSSY WALL TILE

REVESTIMIENTO UNICOLOR BRILLANTE . FAÏENCE UNI BRILLANTE . GLÄNZENDE STEINGUT WANDFLIESEN UNI



PC223 . UNI LIMA 97x297 mm
PC391 . UNI TROPICAL 97x297 mm
PC91 . UNI PERGAMON 97x297 mm
PG439M . UNI TROPICAL 297x297 mm



PC 392 • uni cereja
brilho . glossy . brillo . brilliant . glänzend
8,3 mm



PC 86 • uni estanho
brilho . glossy . brillo . brilliant . glänzend
8,3 mm



PC 224 • uni tangerina
brilho . glossy . brillo . brilliant . glänzend
8,3 mm



PC 393 • uni papoila
brilho . glossy . brillo . brilliant . glänzend
8,3 mm



PC 87 • uni prata
brilho . glossy . brillo . brilliant . glänzend
8,3 mm



PC 312 • uni gema
brilho . glossy . brillo . brilliant . glänzend
8,3 mm

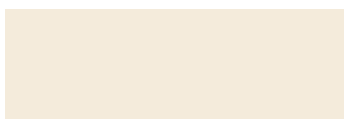

PC 91 • uni pergamon
brilho . glossy . brillo . brilliant . glänzend
8,3 mm

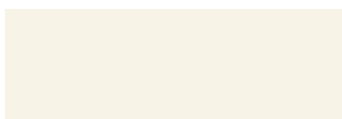

PC 88 • uni gelo
brilho . glossy . brillo . brilliant . glänzend
8,3 mm



PC 223 • uni lima
brilho . glossy . brillo . brilliant . glänzend
8,3 mm

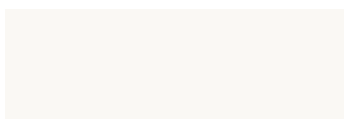

PC 113 • uni cristal
brilho . glossy . brillo . brilliant . glänzend
8,3 mm



PC 89 • uni moka
brilho . glossy . brillo . brilliant . glänzend
8,3 mm



PC 391 • uni tropical
brilho . glossy . brillo . brilliant . glänzend
8,3 mm



PC 85 • uni carvão
brilho . glossy . brillo . brilliant . glänzend
8,3 mm



PC 90 • uni baunilha
brilho . glossy . brillo . brilliant . glänzend
8,3 mm



PC 388 • uni céu
brilho . glossy . brillo . brilliant . glänzend
8,3 mm



PC 225 • uni metal
brilho . glossy . brillo . brilliant . glänzend
8,3 mm



PC 222 • uni meloa
brilho . glossy . brillo . brilliant . glänzend
8,3 mm



PC 390 • uni indigo
brilho . glossy . brillo . brilliant . glänzend
8,3 mm

1977

K107



PAVIMENTO / REVESTIMENTO
FLOOR / WALL TILES
PAVIMENTO / REVESTIMIENTO
REVÊTEMENT DE SOLS / DE MURS
BODENFLIESEN / WANDFLIESEN



MATE
MATT
MATE
MAT
MATT



REVESTIMENTO
WALL
REVESTIMIENTO
FAÏENCE
WANDFLIESEN



BRILHO
GLOSSY
BRILLANTE
BRILLANTE
GLÄNZENDE

GRÉS PORCELÂNICO TÉCNICO
HOMOGENEOUS TECHNICAL PORCELAIN TILES
GRÉS PORCELÂNICO TÉCNICO
GRÉS CÉRAME TECHNIQUE
TECHNIK UNGLASIERTES FEINSTEINZEUG

GRÉS VIDRADO
GLAZED VITRIFIED TILES
GRÉS VIDRIADO
GRÉS ÉMAILLÉ
GLASIERTES STEINZEUG

REVESTIMENTO UNICOLOR BRILHANTE
UNI GLOSSY WALL TILE
REVESTIMIENTO UNICOLOR BRILLANTE
FAÏENCE UNI BRILLANTE
GLÄNZENDE STEINGUT WANDFLIESEN UNI

197x197mm

GRÉS PORCELÂNICO TÉCNICO . HOMOGENEOUS TECHNICAL PORCELAIN TILES

GRÉS PORCELÂNICO TÉCNICO . GRÉS CÉRAME TECHNIQUE . TECHNIK UNGLASIERTES FEINSTEINZEUG



PG2 . UNI GELO 197x197 mm

PG2X . UNI GELO 197x197 mm

PG19007 . UNI GELO+UNI MINERAL 297x297 mm (≈19x19 mm)

PG363X . UNI MINERAL 197x197 mm



8,3

197x197mm

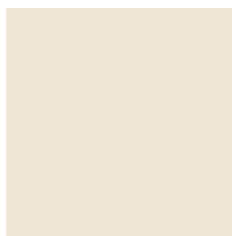
GRÉS PORCELÂNICO TÉCNICO . HOMOGENEOUS TECHNICAL PORCELAIN TILES
GRÉS PORCELÂNICO TÉCNICO . GRÉS CÉRAMÉ TECHNIQUE . TECHNIK UNGLASIERTES FEINSTEINZEUG

PG 60 • **uni pergamon** • R9A
mate . mat . matt • 8,3 mm
U4 P4

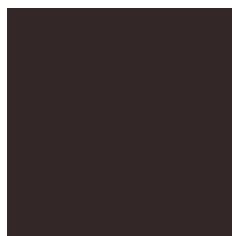

PG 66 • **uni carvão** • R9A
mate . mat . matt • 8,3 mm
U4 P4

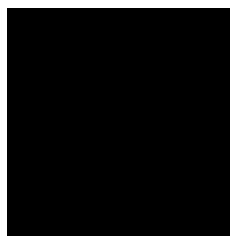

PG 369 • **uni preto** • R9A
mate . mat . matt • 8,3 mm
U4 P4



PG 96 • **uni metal** • R9A
mate . mat . matt • 8,3 mm
U4 P4



PG 52 • **uni estanho** • R9A
mate . mat . matt • 8,3 mm
U4 P4



PG 243 • **fino carvão** • R9A
mate . mat . matt • 8,3 mm
U4 P4



PG 474 • **fino preto** • R9A
mate . mat . matt • 8,3 mm
U4 P4

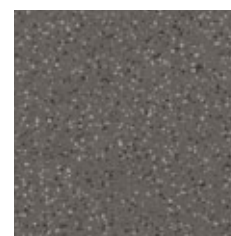

PG 219 • **fino metal** • R9A
mate . mat . matt • 8,3 mm
U4 P4

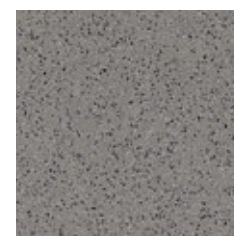

PG 104 • **fino estanho** • R9A
mate . mat . matt • 8,3 mm
U4 P4



PG 62 • **uni pérola** • R9A
mate . mat . matt • 8,3 mm
U4 P4

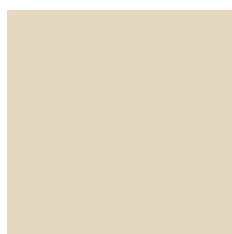

PG 58 • **uni papiro** • R9A
mate . mat . matt • 8,3 mm
U4 P4

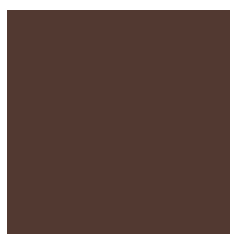

PG 95 • **uni chocolate** • R9A
mate . mat . matt • 8,3 mm
U4 P4

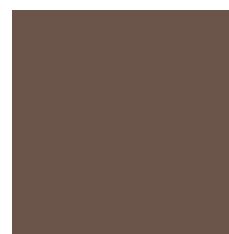

PG 97 • **uni cacau** • R9A
mate . mat . matt • 8,3 mm
U4 P4



PG 53 • **uni moka** • R9A
mate . mat . matt • 8,3 mm
U4 P4

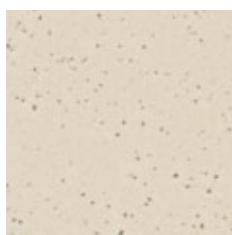

PG 525 • **fino pérola** • R9A
mate . mat . matt • 8,3 mm
U4 P4

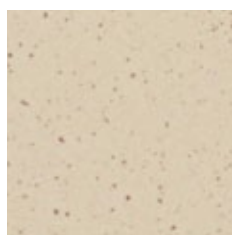

PG 483 • **fino papiro** • R9A
mate . mat . matt • 8,3 mm
U4 P4



PG 508 • **fino cacau** • R9A
mate . mat . matt • 8,3 mm
U4 P4



PG 102 • **fino moka** • R9A
mate . mat . matt • 8,3 mm
U4 P4



97x197 mm

Rodapé prensado curvo mate . Pressed cove base sit-in matt
Rodapié prensado curvo mate . Plinthe à gorge mat . Hohlkehlssockel matt
VER . SEE . VOIR . SIEHE REF. PG. 186 / 190



GI



GE

25x97 mm

Ângulo interno e ângulo externo para rodapé curvo 97x197 mm
Internal angle and external angle for cove base 97x197 mm
Ângulo interno y ángulo externo para rodapié curvo 97x197 mm
Angle intérieur et angle extérieur pour plinthe à gorge 97x197 mm
Innenecken und Aussenecken für Hohlkehlssockel 97x197 mm
VER . SEE . VOIR . SIEHE REF. PG. 187 / 191



PG 367 • **uni zinco** • R9A
mate . mat . matt • 8,3 mm



PG 50 • **uni prata** • R9A
mate . mat . matt • 8,3 mm
U4 P4

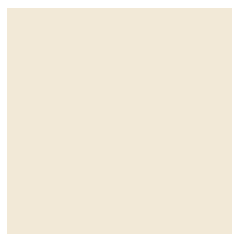

PG 2 • **uni gelo** • R9A
mate . mat . matt • 8,3 mm
U4 P4



PG 402 • **fino zinco** • R9A
mate . mat . matt • 8,3 mm
U4 P4



PG 105 • **fino gelo** • R9A
mate . mat . matt • 8,3 mm
U4 P4

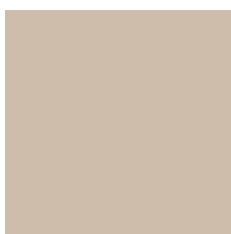

PG 54 • **uni bege** • R9A
mate . mat . matt • 8,3 mm
U4 P4



PG 51 • **uni baunilha** • R9A
mate . mat . matt • 8,3 mm
U4 P4



PG 363 • **uni mineral** • R9A
mate . mat . matt • 8,3 mm
U4 P4



PG 254 • **fino bege** • R9A
mate . mat . matt • 8,3 mm
U4 P4

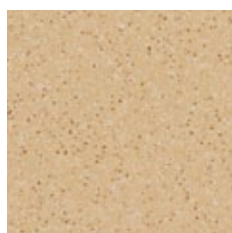

PG 103 • **fino baunilha** • R9A
mate . mat . matt • 8,3 mm
U4 P4



PG 389 • **fino mineral** • R9A
mate . mat . matt • 8,3 mm
U4 P4

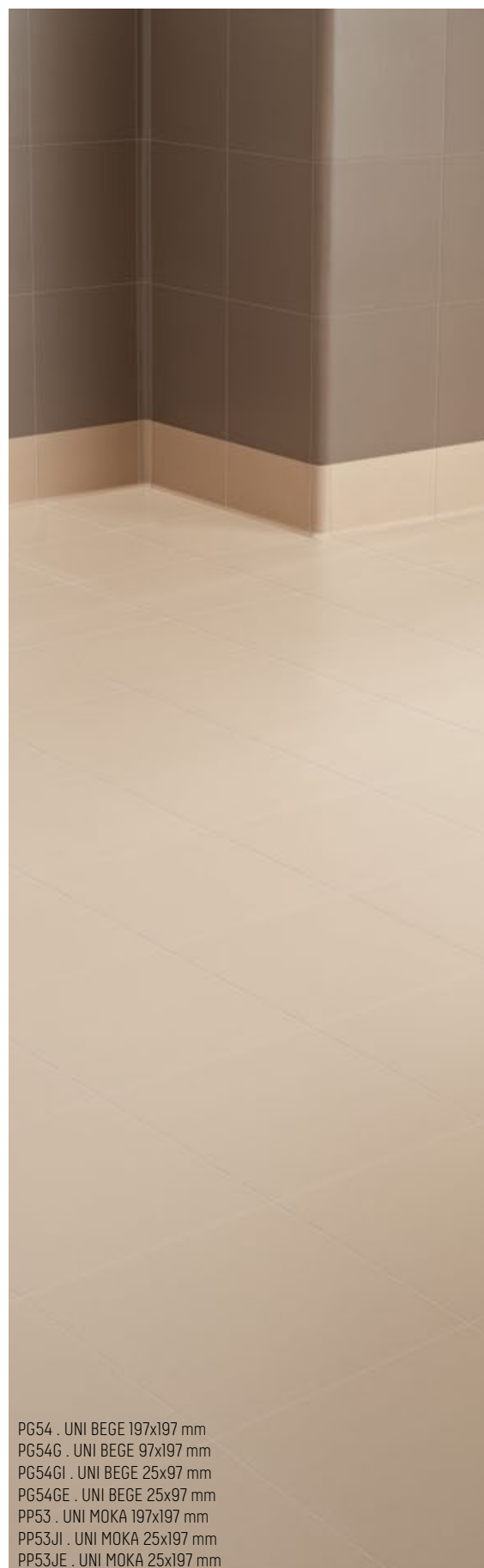

PG54 . UNI BEGE 197x197 mm
PG54G . UNI BEGE 97x197 mm
PG54GI . UNI BEGE 25x97 mm
PG54GE . UNI BEGE 25x97 mm
PP53 . UNI MOKA 197x197 mm
PP53JI . UNI MOKA 25x197 mm
PP53JE . UNI MOKA 25x197 mm

197x197mm

GRÉS VIDRADO . GLAZED VITRIFIED TILES
GRÉS VIDRIADO . GRÈS ÉMAILLÉ . GLASIERTES STEINZEUG



PP386 . UNI FÉNIX 197x197 mm
PP150 . UNI MELOA 197x197 mm
PP119 . UNI SOL 197x197 mm
PP96 . UNI METAL 197x197 mm
PP368 . UNI NÉVOA 197x197 mm
PG263 . UNI METAL 597x597 mm

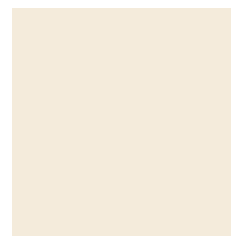
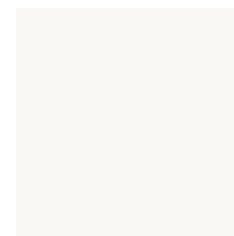
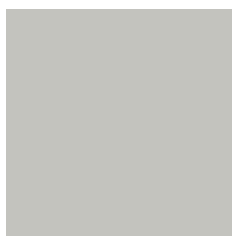
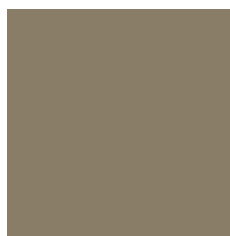
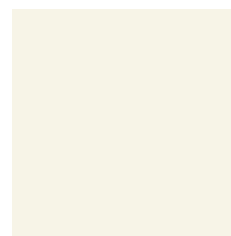
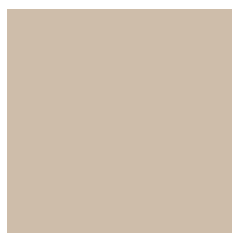

6

197x197mmGRÉS VIDRADO . GLAZED VITRIFIED TILES
GRÉS VIDRIADO . GRÉS ÉMAILLÉ . GLASIERTES STEINZEUG**PP 358 • uni cereja**
mate . mat . matt • 6 mm
II / U2**PP 385 • uni vermelho**
mate . mat . matt • 6 mm
II / U2**PP 387 • uni papoila**
mate . mat . matt • 6 mm
II / U2**PP 60 • uni pergamon**
mate . mat . matt • 6 mm
IV / U3**PP 61 • uni cristal**
mate . mat . matt • 6 mm
IV / U3**PP 50 • uni prata**
mate . mat . matt • 6 mm
IV / U3**PP 368 • uni névoa**
mate . mat . matt • 6 mm
IV / U3**PP 375 • uni caqui**
mate . mat . matt • 6 mm
II / U2**PP 2 • uni gelo**
mate . mat . matt • 6 mm
IV / U3**PP 62 • uni pérola**
mate . mat . matt • 6 mm
IV / U3**PP 364 • uni capuccino**
mate . mat . matt • 6 mm
III / U2S**PP 54 • uni bege**
mate . mat . matt • 6 mm
III / U2S**PP 99 • uni ouro**
mate . mat . matt • 6 mm
II / U2**PP 93 • uni caramelo**
mate . mat . matt • 6 mm
II / U2**PP 365 • uni salmão**
mate . mat . matt • 6 mm
III / U2S**PP 370 • uni ocre**
mate . mat . matt • 6 mm
III / U2S**PP 119 • uni sol**
mate . mat . matt • 6 mm
IV**PP 118 • uni tangerina**
mate . mat . matt • 6 mm
II / U2**PP 386 • uni fénix**
mate . mat . matt • 6 mm
III / U2S**PP 143 • uni gema**
mate . mat . matt • 6 mm
III / U2S

97x197 mm

Rodapé prensado curvo mate . Pressed cove base sit-in matt
Rodapié prensado curvo mate . Plinthe à gorge mat . Hohlkehlsocbel matt
VER . SEE . VOIR . SIEHE REF. PG. 183

JI

JE

25x197 mm

Meia cana interna e meia cana externa
Internal cove and external cove
Media caña interna y media caña externa
Gorge interieur et gorge exterieur
Innenrundung glasiert und Aussenrundung glasiert
VER . SEE . VOIR . SIEHE REF. PG. 183

GI

GE

25x97 mm

Ângulo interno e ângulo externo para rodapé curvo 97x197 mm
Internal angle and external angle for cove base
Angulo interno y angulo externo para rodapié curvo
Angle intérieur et angle extérieur pour plinthe à gorge
Innenecken und Aussenecken für Hohlkehlsocbel
VER . SEE . VOIR . SIEHE REF. PG. 183

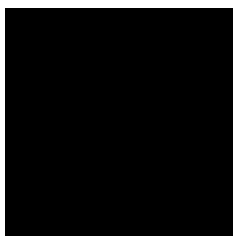

PP 400 • uni ébano
mate . mat . matt • 6 mm
II / U2

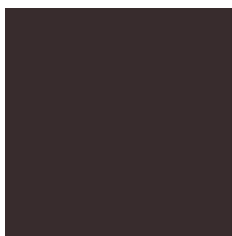

PP 66 • uni carvão
mate . mat . matt • 6 mm
I



PP 96 • uni metal
mate . mat . matt • 6 mm
I

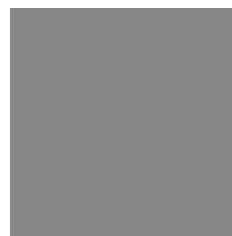

PP 52 • uni estanho
mate . mat . matt • 6 mm
II / U2



PP 367 • uni zinco
mate . mat . matt • 6 mm
IV / U3

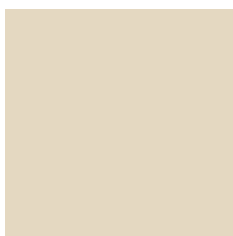

PP 58 • uni papiro
mate . mat . matt • 6 mm
IV / U3



PP 554 • uni creme
mate . mat . matt • 6 mm
III

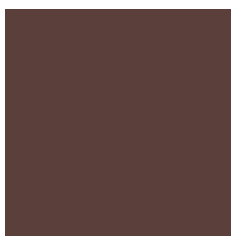

PP 95 • uni chocolate
mate . mat . matt • 6 mm
I

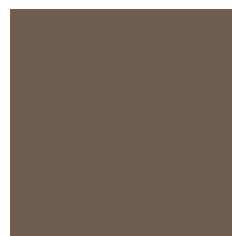

PP 97 • uni cacau
mate . mat . matt • 6 mm
I



PP 53 • uni moka
mate . mat . matt • 6 mm
II / U2



PP 366 • uni cotto
mate . mat . matt • 6 mm
II / U2



PP 51 • uni baunilha
mate . mat . matt • 6 mm
III / U2S



PP 63 • uni amêndoa
mate . mat . matt • 6 mm
II / U2



PP 149 • uni papaia
mate . mat . matt • 6 mm
II / U2



PP 150 • uni meloa
mate . mat . matt • 6 mm
III / U2S



PP 142 • uni lima
mate . mat . matt • 6 mm
III / U2S



PP 374 • uni musgo
mate . mat . matt • 6 mm
III / U2S



PP 371 • uni grama
mate . mat . matt • 6 mm
III / U2S



PP 356 • uni maçã
mate . mat . matt • 6 mm
IV / U3



PP 373 • uni limonete
mate . mat . matt • 6 mm
IV / U3

6

197x197mm

GRÉS VIDRADO . GLAZED VITRIFIED TILES
GRÉS VIDRIADO . GRÈS ÉMAILLÉ . GLASIERTES STEINZEUG

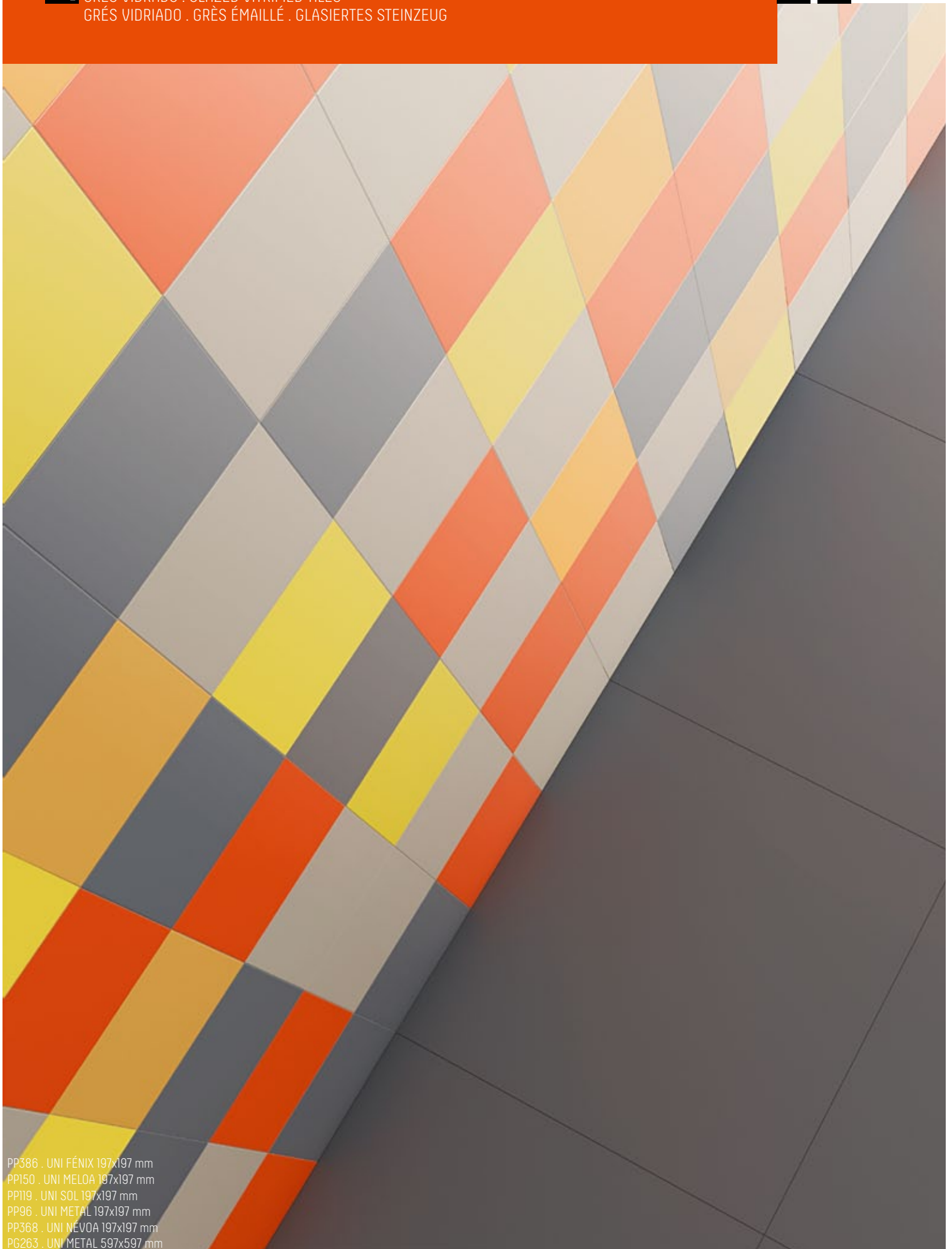

PP386 . UNI FÉNIX 197x197 mm
PP150 . UNI MELOA 197x197 mm
PP119 . UNI SOL 197x197 mm
PP96 . UNI METAL 197x197 mm
PP368 . UNI NÉVOA 197x197 mm
PG263 . UNI METAL 597x597 mm



PP 372 • uni trevo
mate . mat . matt • 6 mm
III / U2S



PP 55 • uni menta
mate . mat . matt • 6 mm
II / U2



PP 59 • uni turquesa
mate . mat . matt • 6 mm
IV / U3



PP 377 • uni jade
mate . mat . matt • 6 mm
II / U2



PP 376 • uni tropical
mate . mat . matt • 6 mm
II / U2



PP 363 • uni mineral
mate . mat . matt • 6 mm
III / U2S



PP 116 • uni céu
mate . mat . matt • 6 mm
II / U2



PP 115 • uni lago
mate . mat . matt • 6 mm
II / U2



PP 379 • uni safira
mate . mat . matt • 6 mm
III / U2S



PP 65 • uni água
mate . mat . matt • 6 mm
III / U2S



PP 380 • uni navy
mate . mat . matt • 6 mm
II / U2



PP 381 • uni marine
mate . mat . matt • 6 mm
II / U2



PP 382 • uni lavanda
mate . mat . matt • 6 mm
III / U2S



PP 357 • uni indigo
mate . mat . matt • 6 mm
II / U2



PP 144 • uni agapante
mate . mat . matt • 6 mm
II / U2



PP 383 • uni purpura
mate . mat . matt • 6 mm
II / U2



PP 145 • uni alfazema
mate . mat . matt • 6 mm
III / U2S

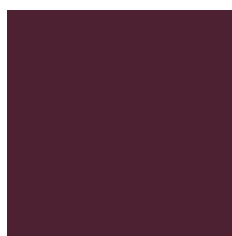

PP 384 • uni beringela
mate . mat . matt • 6 mm
II / U2

 97x197 mm
Rodapé prensado curvo mate . Pressed cove base sit-in matt
Rodapié prensado curvo mate . Plinthe à gorge mat . Hohlkehlsocbel matt
VER . SEE . VOIR . SIEHE REF. PG. 183



25x197 mm
Meia cana interna e meia cana externa
Internal cove and external cove
Media caña interna y media caña externa
Gorge intérieur et gorge extérieur
Innenrundung glasiert und Aussenrundung glasiert
VER . SEE . VOIR . SIEHE REF. PG. 183



25x97 mm
Ângulo interno e ângulo externo para rodapé curvo 97x197 mm
Internal angle and external angle for cove base
Angulo interno y angulo externo para rodapié curvo
Angle intérieur et angle extérieur pour plinthe à gorge
Innenecken und Aussenecken für Hohlkehlsocbel
VER . SEE . VOIR . SIEHE REF. PG. 183

**197x197mm**

REVESTIMENTO UNICOLOR BRILHANTE . UNI GLOSSY WALL TILE

REVESTIMIENTO UNICOLOR BRILLANTE . FAÏENCE UNI BRILLANTE . GLÄNZENDE STEINGUT WANDFLIESEN UNI



PC 358 • uni cereja
brilho . glossy . brillo
brilliant . glänzend • 7 mm



PC 385 • uni vermelho
brilho . glossy . brillo
brilliant . glänzend • 7 mm



PC 387 • uni papoila
brilho . glossy . brillo
brilliant . glänzend • 7 mm

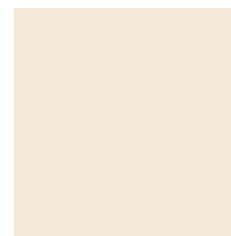

PC 60 • uni pergamon
brilho . glossy . brillo
brilliant . glänzend • 7 mm

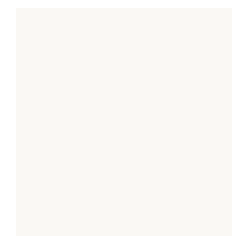

PC 61 • uni cristal
brilho . glossy . brillo
brilliant . glänzend • 7 mm



PC 50 • uni prata
brilho . glossy . brillo
brilliant . glänzend • 7 mm



PC 368 • uni névoa
brilho . glossy . brillo
brilliant . glänzend • 7 mm

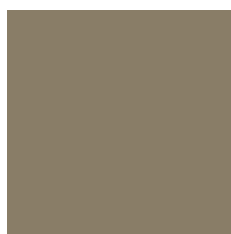

PC 375 • uni caqui
brilho . glossy . brillo
brilliant . glänzend • 7 mm

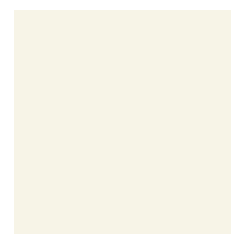

PC 2 • uni gelo
brilho . glossy . brillo
brilliant . glänzend • 7 mm



PC 62 • uni pérola
brilho . glossy . brillo
brilliant . glänzend • 7 mm



PC 364 • uni cappuccino
brilho . glossy . brillo
brilliant . glänzend • 7 mm



PC 54 • uni bege
brilho . glossy . brillo
brilliant . glänzend • 7 mm



PC 99 • uni ouro
brilho . glossy . brillo
brilliant . glänzend • 7 mm



PC 93 • uni caramelo
brilho . glossy . brillo
brilliant . glänzend • 7 mm



PC 365 • uni salmão
brilho . glossy . brillo
brilliant . glänzend • 7 mm



PC 370 • uni ocre
brilho . glossy . brillo
brilliant . glänzend • 7 mm



PC 119 • uni sol
brilho . glossy . brillo
brilliant . glänzend • 7 mm



PC 118 • uni tangerina
brilho . glossy . brillo
brilliant . glänzend • 7 mm



PC 386 • uni fénix
brilho . glossy . brillo
brilliant . glänzend • 7 mm



PC 143 • uni gema
brilho . glossy . brillo
brilliant . glänzend • 7 mm

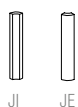

25x197 mm

Meia cana interna e meia cana externa

Internal cove and external cove

Media caña interna y media caña externa

Gorge interieur et gorge extérieur

Innenrundung glasiert und Aussenrundung glasiert

VER . SEE . VOIR . SIEHE REF. PG. 182

31x197 mm

Listelos . Borders . Listelos . Listels . Bordüren

VER . SEE . VOIR . SIEHE REF. PG. 182

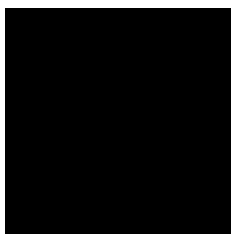

PC 400 • uni ébano
brilho . glossy . brillo
brilliant . glänzend • 7 mm

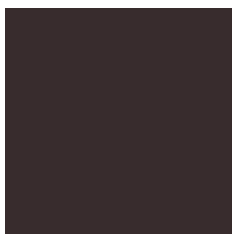

PC 66 • uni carvão
brilho . glossy . brillo
brilliant . glänzend • 7 mm

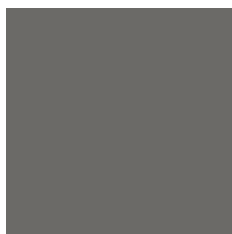

PC 96 • uni metal
brilho . glossy . brillo
brilliant . glänzend • 7 mm



PC 52 • uni estanho
brilho . glossy . brillo
brilliant . glänzend • 7 mm



PC 367 • uni zinco
brilho . glossy . brillo
brilliant . glänzend • 7 mm

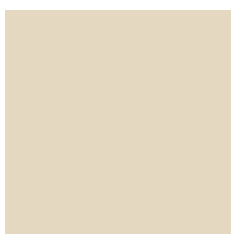

PC 58 • uni papiro
brilho . glossy . brillo
brilliant . glänzend • 7 mm



PC 554 • uni creme
brilho . glossy . brillo
brilliant . glänzend • 7 mm

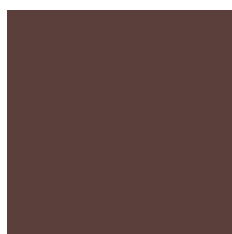

PC 95 • uni chocolate
brilho . glossy . brillo
brilliant . glänzend • 7 mm

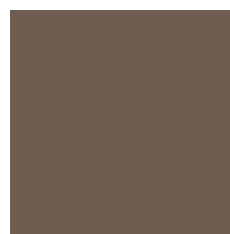

PC 97 • uni cacau
brilho . glossy . brillo
brilliant . glänzend • 7 mm



PC 53 • uni moka
brilho . glossy . brillo
brilliant . glänzend • 7 mm

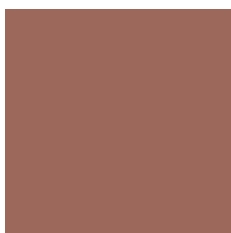

PC 366 • uni cotto
brilho . glossy . brillo
brilliant . glänzend • 7 mm

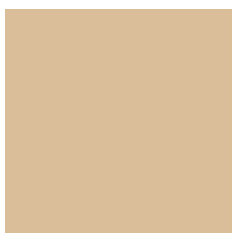

PC 51 • uni baunilha
brilho . glossy . brillo
brilliant . glänzend • 7 mm



PC 63 • uni amêndoa
brilho . glossy . brillo
brilliant . glänzend • 7 mm



PC 149 • uni papaia
brilho . glossy . brillo
brilliant . glänzend • 7 mm



PC 150 • uni meloa
brilho . glossy . brillo
brilliant . glänzend • 7 mm



PC 142 • uni lima
brilho . glossy . brillo
brilliant . glänzend • 7 mm



PC 374 • uni musgo
brilho . glossy . brillo
brilliant . glänzend • 7 mm



PC 371 • uni grama
brilho . glossy . brillo
brilliant . glänzend • 7 mm



PC 356 • uni maçã
brilho . glossy . brillo
brilliant . glänzend • 7 mm



PC 373 • uni limonete
brilho . glossy . brillo
brilliant . glänzend • 7 mm

7

197x197mm

REVESTIMENTO UNICOLOR BRILHANTE . UNI GLOSSY WALL TILE

REVESTIMIENTO UNICOLOR BRILLANTE . FAÏENCE UNI BRILLANTE . GLÄNZENDE STEINGUT WANDFLIESEN UNI



PC380 . UNI NAVY 197x197 mm
PC381 . UNI MARINE 197x197 mm
PC61 . UNI CRISTAL 197x197 mm



PC 372 • uni trevo
brilho . glossy . brillo
brilliant . glänzend • 7 mm



PC 55 • uni menta
brilho . glossy . brillo
brilliant . glänzend • 7 mm



PC 59 • uni turquesa
brilho . glossy . brillo
brilliant . glänzend • 7 mm



PC 377 • uni jade
brilho . glossy . brillo
brilliant . glänzend • 7 mm



PC 376 • uni tropical
brilho . glossy . brillo
brilliant . glänzend • 7 mm



PC 363 • uni mineral
brilho . glossy . brillo
brilliant . glänzend • 7 mm

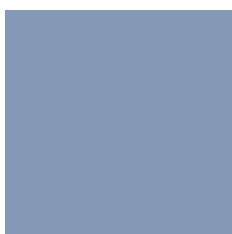

PC 116 • uni céu
brilho . glossy . brillo
brilliant . glänzend • 7 mm



PC 115 • uni lago
brilho . glossy . brillo
brilliant . glänzend • 7 mm



PC 379 • uni safira
brilho . glossy . brillo
brilliant . glänzend • 7 mm

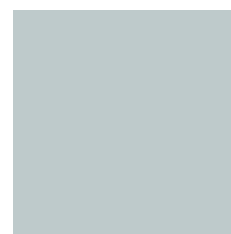

PC 65 • uni água
brilho . glossy . brillo
brilliant . glänzend • 7 mm



PC 380 • uni navy
brilho . glossy . brillo
brilliant . glänzend • 7 mm



PC 381 • uni marine
brilho . glossy . brillo
brilliant . glänzend • 7 mm

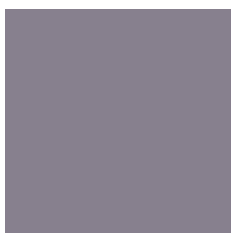

PC 382 • uni lavanda
brilho . glossy . brillo
brilliant . glänzend • 7 mm



PC 357 • uni indigo
brilho . glossy . brillo
brilliant . glänzend • 7 mm



PC 144 • uni agapante
brilho . glossy . brillo
brilliant . glänzend • 7 mm



PC 383 • uni purpura
brilho . glossy . brillo
brilliant . glänzend • 7 mm

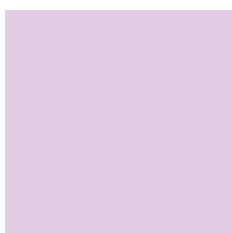

PC 145 • uni alfazema
brilho . glossy . brillo
brilliant . glänzend • 7 mm

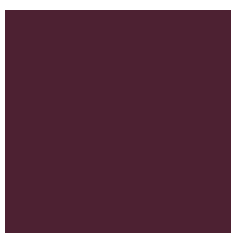

PC 384 • uni beringela
brilho . glossy . brillo
brilliant . glänzend • 7 mm

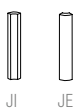

25x197 mm

Meia cana interna e meia cana externa

Internal cove and external cove

Media caña interna y media caña externa

Gorge interieur et gorge exterieur

Innenrundung glasiert und Ausserrundung glasiert

VER . SEE . VOIR . SIEHE REF. PG. 182

31x197 mm

Listelos . Borders . Listelos . Listels . Bordüren

VER . SEE . VOIR . SIEHE REF. PG. 182

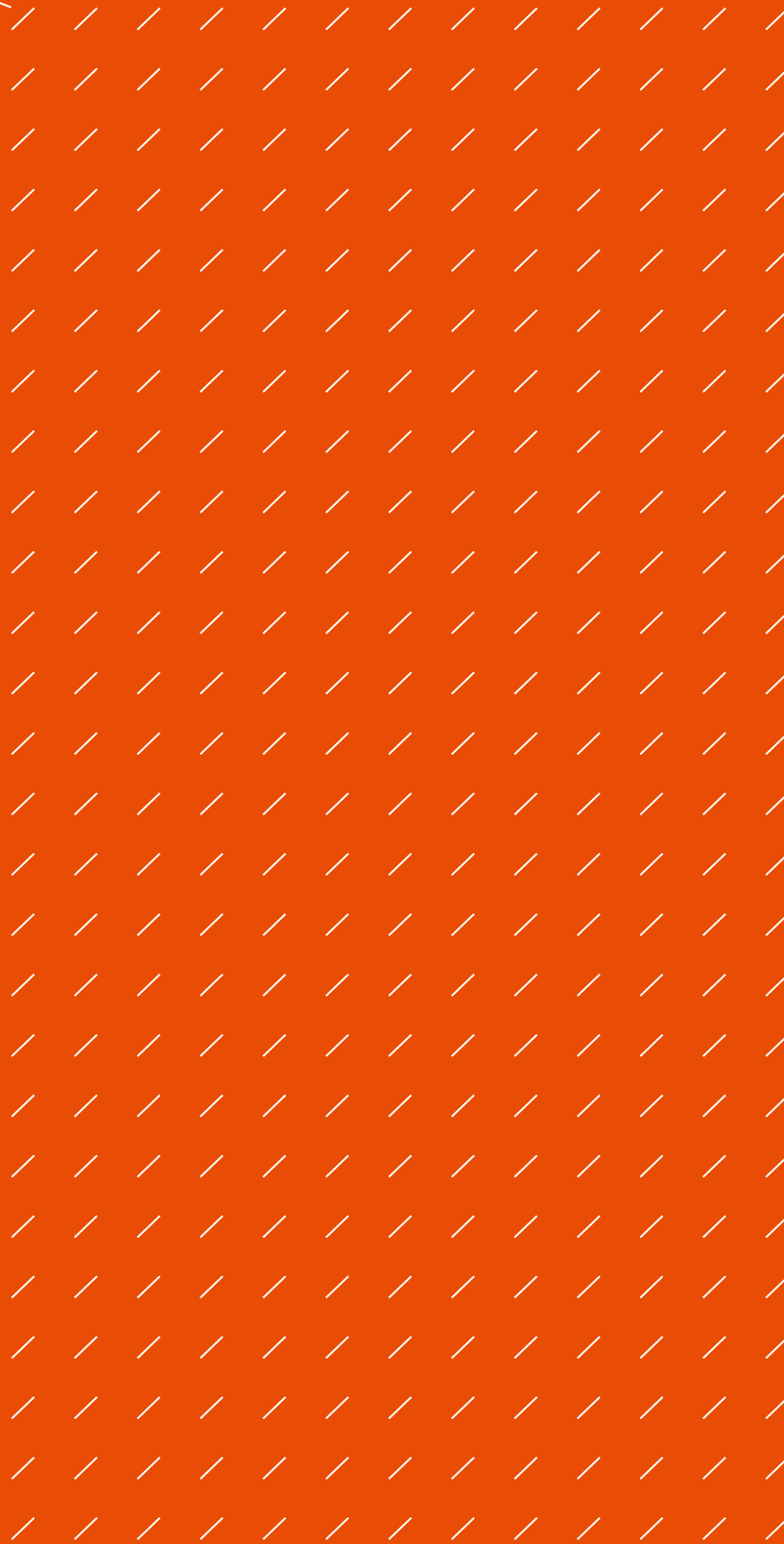

8.3

147x147mm

GRÉS PORCELÂNICO TÉCNICO . HOMOGENEOUS TECHNICAL PORCELAIN TILES
GRÉS PORCELÂNICO TÉCNICO . GRÈS CÉRAMÉ TECHNIQUE . TECHNIK UNGLASIERTES FEINSTEINZEUG



R9A



PP398 . UNI VERMELHO 147x147 mm
PP43 . UNI CARVÃO 147x147 mm
PG43 . UNI CARVÃO 147x147 mm

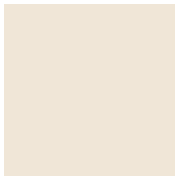

PG 49 • **uni pergamon** • R9A
mate . mat . matt • 8,3 mm
U4 P4



PG 43 • **uni carvão** • R9A
mate . mat . matt • 8,3 mm
U4 P4



PG 475 • **uni preto** • R9A
mate . mat . matt • 8,3 mm
U4 P4



PG 44 • **uni estanho** • R9A
mate . mat . matt • 8,3 mm
U4 P4



PG 45 • **uni prata** • R9A
mate . mat . matt • 8,3 mm
U4 P4

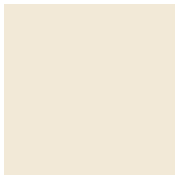

PG 46 • **uni gelo** • R9A
mate . mat . matt • 8,3 mm
U4 P4



PG 505 • **uni pérola** • R9A
mate . mat . matt • 8,3 mm



PG 47 • **uni moka** • R9A
mate . mat . matt • 8,3 mm
U4 P4



PG 48 • **uni baunilha** • R9A
mate . mat . matt • 8,3 mm
U4 P4

6

147x147mm

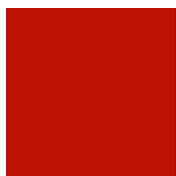
GRÉS VIDRADO . GLAZED VITRIFIED TILES
GRÉS VIDRIADO . GRÉS ÉMAILLÉ . GLASIERTES STEINZEUG

PP 398 • **uni vermelho**
mate . mat . matt • 6 mm
II / U2

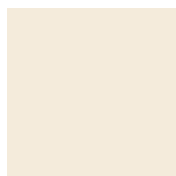

PP 49 • **uni pergamon**
mate . mat . matt • 6 mm
IV / U3

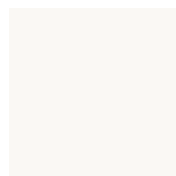

PP 201 • **uni cristal**
mate . mat . matt • 6 mm
IV / U3



PP 43 • **uni carvão**
mate . mat . matt • 6 mm
I



PP 44 • **uni estanho**
mate . mat . matt • 6 mm
II / U2



PP 45 • **uni prata**
mate . mat . matt • 6 mm
IV / U3

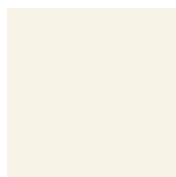

PP 46 • **uni gelo**
mate . mat . matt • 6 mm
IV / U3



PP 47 • **uni moka**
mate . mat . matt • 6 mm
II / U2



PP 48 • **uni baunilha**
mate . mat . matt • 6 mm
III / U2S



PP 477 • **uni ocre**
mate . mat . matt • 6 mm
III / U2S



PP 286 • **uni tangerina**
mate . mat . matt • 6 mm
II



PP 283 • **uni gema**
mate . mat . matt • 6 mm
III



PP 282 • **uni lima**
mate . mat . matt • 6 mm
III



PP 399 • **uni maçã**
mate . mat . matt • 6 mm
IV / U3



PP 301 • **uni turquesa**
mate . mat . matt • 6 mm
IV / U3



PP 397 • **uni tropical**
mate . mat . matt • 6 mm
II / U2



PP 299 • **uni lago**
mate . mat . matt • 6 mm
II



PP 396 • **uni safira**
mate . mat . matt • 6 mm
III / U2S



PP 395 • **uni navy**
mate . mat . matt • 6 mm
II / U2



PP 476 • **uni indigo**
mate . mat . matt • 6 mm
II

**147x147mm**REVESTIMENTO UNICOLOR BRILHANTE . UNI GLOSSY WALL TILE
REVESTIMIENTO UNICOLOR BRILLANTE . FÁÏENCE UNI BRILLANTE
GLÄNZENDE STEINGUT WANDFLIESEN UNI

PC 398 • uni vermelho
brilho . glossy . brillo
brilliant . glänzend • 7 mm

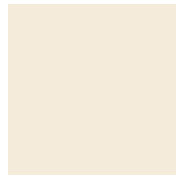

PC 49 • uni pergamon
brilho . glossy . brillo
brilliant . glänzend • 7 mm

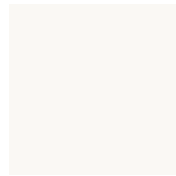

PC 201 • uni cristal
brilho . glossy . brillo
brilliant . glänzend • 7 mm



PC 43 • uni carvão
brilho . glossy . brillo
brilliant . glänzend • 7 mm



PC 44 • uni estanho
brilho . glossy . brillo
brilliant . glänzend • 7 mm

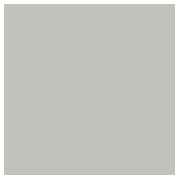

PC 45 • uni prata
brilho . glossy . brillo
brilliant . glänzend • 7 mm

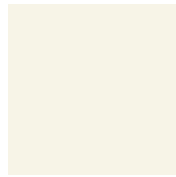

PC 46 • uni gelo
brilho . glossy . brillo
brilliant . glänzend • 7 mm



PC 47 • uni moka
brilho . glossy . brillo
brilliant . glänzend • 7 mm



PC 48 • uni baunilha
brilho . glossy . brillo
brilliant . glänzend • 7 mm



PC 477 • uni ocre
brilho . glossy . brillo
brilliant . glänzend • 7 mm



PC 286 • uni tangerina
brilho . glossy . brillo
brilliant . glänzend • 7 mm



PC 283 • uni gema
brilho . glossy . brillo
brilliant . glänzend • 7 mm



PC 282 • uni lima
brilho . glossy . brillo
brilliant . glänzend • 7 mm



PC 399 • uni maçã
brilho . glossy . brillo
brilliant . glänzend • 7 mm



PC 301 • uni turquesa
brilho . glossy . brillo
brilliant . glänzend • 7 mm

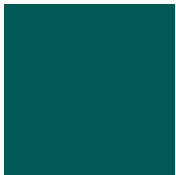

PC 397 • uni tropical
brilho . glossy . brillo
brilliant . glänzend • 7 mm



PC 299 • uni lago
brilho . glossy . brillo
brilliant . glänzend • 7 mm



PC 396 • uni safira
brilho . glossy . brillo
brilliant . glänzend • 7 mm



PC 395 • uni navy
brilho . glossy . brillo
brilliant . glänzend • 7 mm



PC 476 • uni indigo
brilho . glossy . brillo
brilliant . glänzend • 7 mm

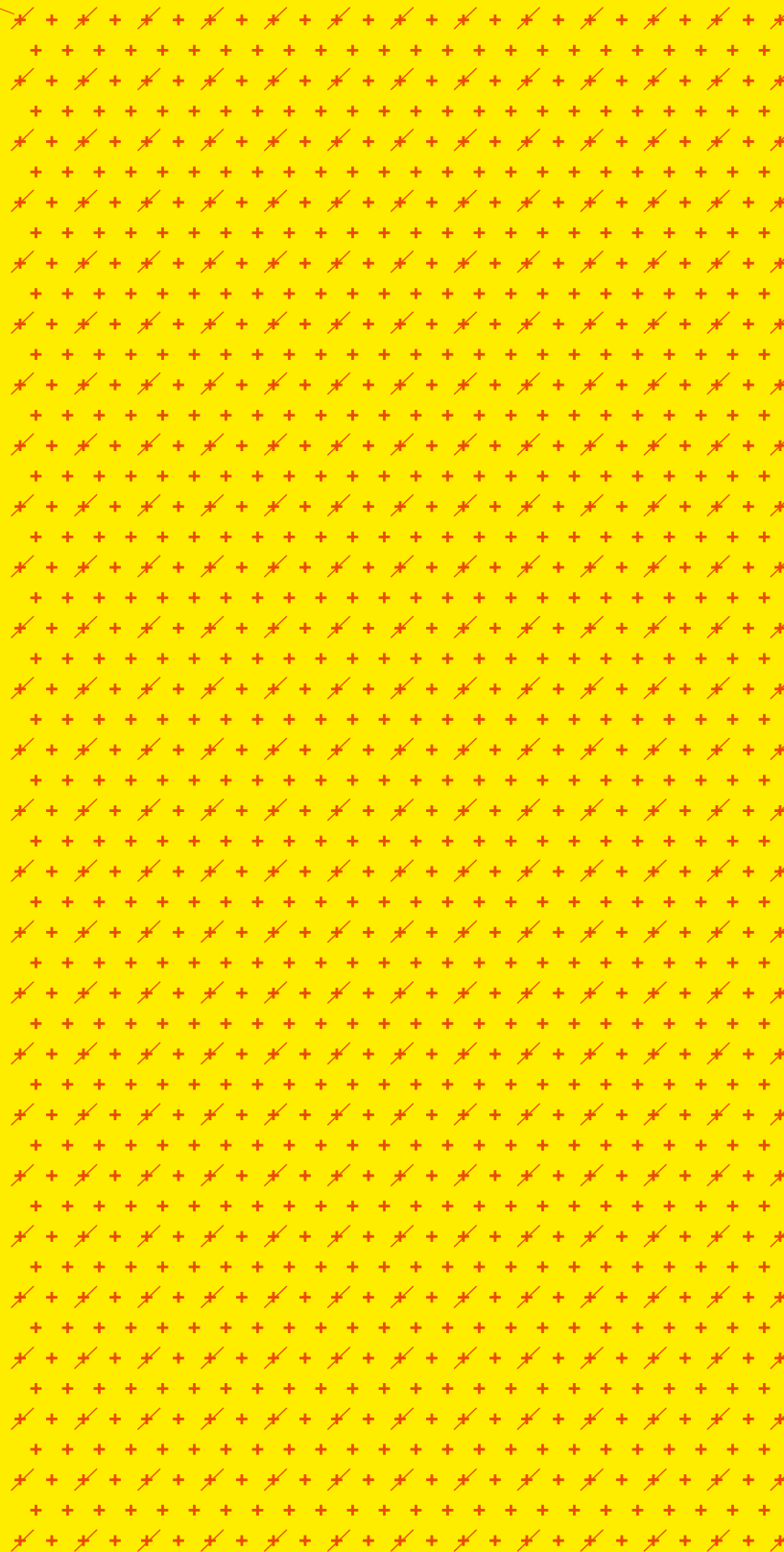

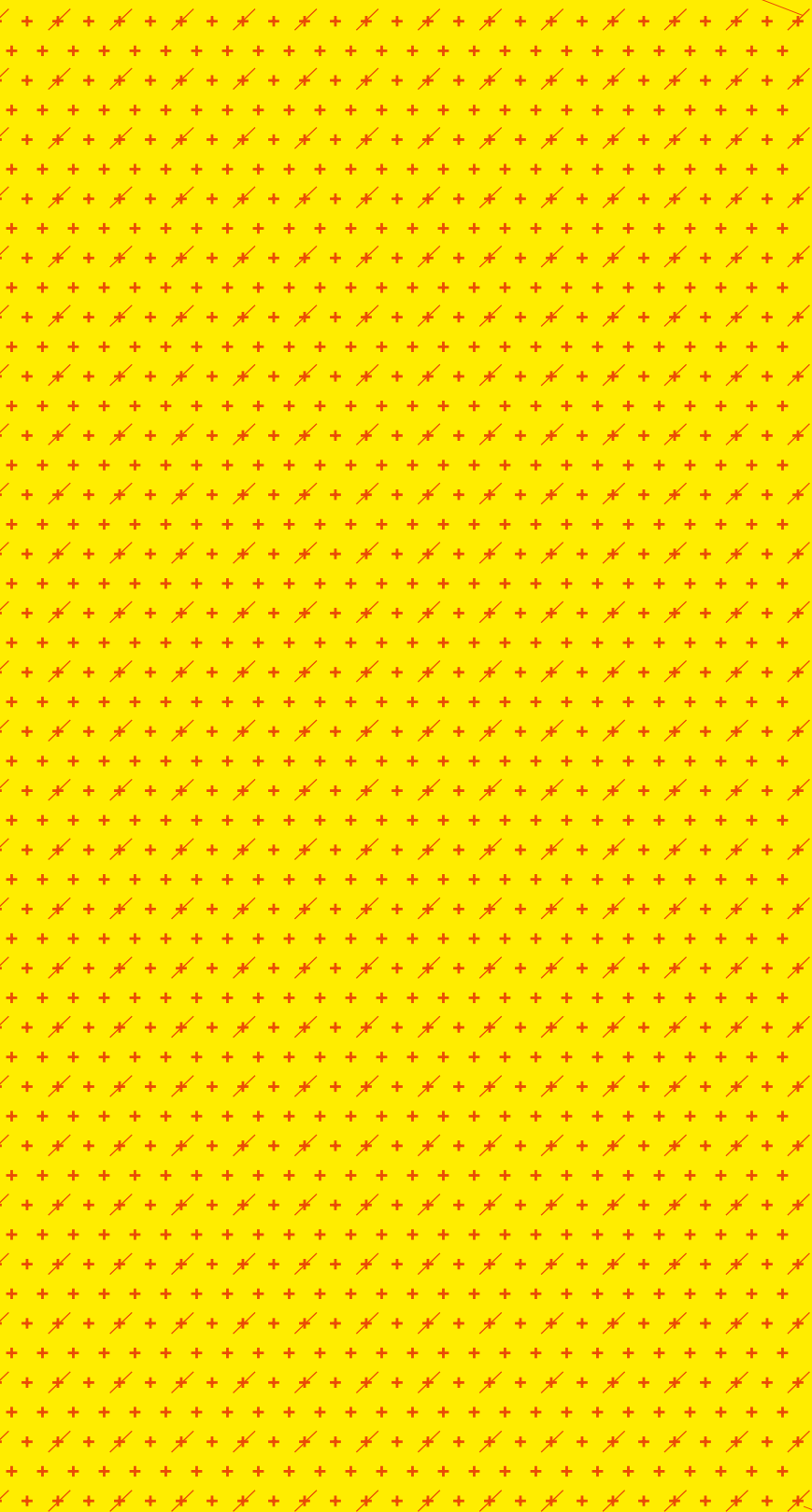

83

97x97mm

GRÉS PORCELÂNICO TÉCNICO . HOMOGENEOUS TECHNICAL PORCELAIN TILES

GRÉS PORCELÂNICO TÉCNICO . GRÉS CÉRAME TECHNIQUE . TECHNIK UNGLASIERTES FEINSTEINZEUG



PGH408 . UNI PRETO 97x97 mm
PGH189 . UNI METAL 97x97mm
PGH406 . UNI ZINCO 97x97mm
PGH160 . UNI PÉROLA 97x97mm



8.3

97x97mm

GRÉS PORCELÁNICO TÉCNICO . HOMOGENEOUS TECHNICAL PORCELAIN TILES

GRÉS PORCELÁNICO TÉCNICO . GRÉS CÉRAME TECHNIQUE . TECHNIK UNGLASIERTES FEINSTEINZEUG



PGH160 . UNI PÉROLA 97x97mm
PGHR160 . UNI PÉROLA R11 97x97mm
PGH127 . UNI MOKA 97x97mm
PGHR127 . UNI MOKA R11 97x97mm



TEXTURADO
TEXTURED . TEXTURÉ . TEXTURIERT

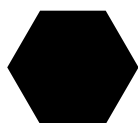

PGH 408 • uni preto
R9A • mate . mat . matt • 8,3 mm
U4 P4



PGH 189 • uni metal
R9A • mate . mat . matt • 8,3 mm
U4 P4



PGH 122 • uni estanho
R9A • mate . mat . matt • 8,3 mm
U4 P4



PGH 135 • uni menta
R9A • mate . mat . matt • 8,3 mm
U4 P4

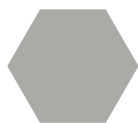

PGH 406 • uni zinco
R9A • mate . mat . matt • 8,3 mm
U4 P4



PGH 160 • uni pérola
R9A • mate . mat . matt • 8,3 mm
U4 P4



PGH 127 • uni moka
R9A • mate . mat . matt • 8,3 mm
U4 P4



PGH 198 • uni céu
R9A • mate . mat . matt • 8,3 mm
U4 P4



TEXTURADO
TEXTURED . TEXTURÉ . TEXTURIERT



PGHR 408 • uni preto
R11B • 8,3 mm
U4 P4



PGHR 189 • uni metal
R11B • 8,3 mm
U4 P4



PGHR 122 • uni estanho
R11B • 8,3 mm
U4 P4

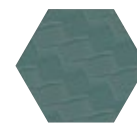

PGHR 135 • uni menta
R11B • 8,3 mm
U4 P4



PGHR 406 • uni zinco
R11B • 8,3 mm
U4 P4



PGHR 160 • uni pérola
R11B • 8,3 mm
U4 P4



PGHR 127 • uni moka
R11B • 8,3 mm
U4 P4

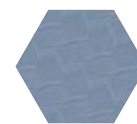

PGHR 198 • uni céu
R11B • 8,3 mm
U4 P4

Outras cores sob consulta
Other colors under inquiry
Autres couleurs sous demande
andere Farbe bei Anfrage

8.3

97x97mm

GRÉS PORCELÂNICO TÉCNICO . HOMOGENEOUS TECHNICAL PORCELAIN TILES
GRÉS PORCELÂNICO TÉCNICO . GRÉS CÉRAME TECHNIQUE . TECHNIK UNGLASIERTES FEINSTEINZEUG



R9A



PG405 . UNI COTTO 97x97 mm



PG405 . UNI COTTO 97x97 mm



PG 133 • uni pergamon • R9A
mate . mat . matt • 8,3 mm
U4 P4



PG 121 • uni carvão • R9A
mate . mat . matt • 8,3 mm
U4 P4



PG 408 • uni preto • R9A
mate . mat . matt • 8,3 mm
U4 P4
PGK 408 • uni preto • R10
mate . mat . matt • 8,3 mm



PG 189 • uni metal • R9A
mate . mat . matt • 8,3 mm
PGK 189 • uni metal • R10
mate . mat . matt • 8,3 mm



PG 122 • uni estanho • R9A
mate . mat . matt • 8,3 mm
U4 P4
PGK 122 • uni estanho • R10
mate . mat . matt • 8,3 mm



PG 406 • uni zinco • R9A
mate . mat . matt • 8,3 mm
U4 P4



PG 124 • uni prata • R9A
mate . mat . matt • 8,3 mm
U4 P4



PG 1 • uni gelo • R9A
mate . mat . matt • 8,3 mm
U4 P4



PG 160 • uni pérola • R9A
mate . mat . matt • 8,3 mm
U4 P4



PG 191 • uni papiro • R9A
mate . mat . matt • 8,3 mm
U4 P4

PGK 406 • uni zinco • R10
mate . mat . matt • 8,3 mm

PGK 124 • uni prata • R10
mate . mat . matt • 8,3 mm

PGK 1 • uni gelo • R10
mate . mat . matt • 8,3 mm

PGK 160 • uni pérola • R10
mate . mat . matt • 8,3 mm

PGK 191 • uni papiro • R10
mate . mat . matt • 8,3 mm



PG 545 • uni creme • R9A
mate . mat . matt • 8,3 mm
PGK 545 • uni creme • R10
mate . mat . matt • 8,3 mm



PG 126 • uni chocolate • R9A
mate . mat . matt • 8,3 mm
U4 P4



PG 127 • uni moka • R9A
mate . mat . matt • 8,3 mm
U4 P4
PGK 127 • uni moka • R10
mate . mat . matt • 8,3 mm



PG 194 • uni bege • R9A
mate . mat . matt • 8,3 mm



PG 134 • uni ouro • R9A
mate . mat . matt • 8,3 mm



PG 405 • uni cotto • R9A
mate . mat . matt • 8,3 mm
U4 P4



PG 131 • uni baunilha • R9A
mate . mat . matt • 8,3 mm
U4 P4



PG 141 • uni gema • R9A
mate . mat . matt • 8,3 mm
U4 P4



PG 140 • uni lima • R9A
mate . mat . matt • 8,3 mm
U4 P4



PG 414 • uni musgo • R9A
mate . mat . matt • 8,3 mm
U4 P4



PG 135 • uni menta • R9A
mate . mat . matt • 8,3 mm
U4 P4



PG 136 • uni turquesa • R9A
mate . mat . matt • 8,3 mm
U4 P4



PG 418 • uni mineral • R9A
mate . mat . matt • 8,3 mm
U4 P4



PG 198 • uni céu • R9A
mate . mat . matt • 8,3 mm
U4 P4



PG 137 • uni lago • R9A
mate . mat . matt • 8,3 mm
U4 P4



PG 213 • fino carvão • R9A
mate . mat . matt • 8,3 mm
U4 P4



PG 480 • fino preto • R9A
mate . mat . matt • 8,3 mm
U4 P4



PG 123 • fino estanho • R9A
mate . mat . matt • 8,3 mm
U4 P4



PG 125 • fino gelo • R9A
mate . mat . matt • 8,3 mm
U4 P4



PG 436 • fino pérola • R9A
mate . mat . matt • 8,3 mm
U4 P4



PG 128 • fino moka • R9A
mate . mat . matt • 8,3 mm
U4 P4

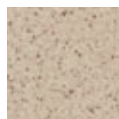

PG 437 • fino bege • R9A
mate . mat . matt • 8,3 mm
U4 P4



PG 132 • fino baunilha • R9A
mate . mat . matt • 8,3 mm
U4 P4

97x97mm

Também disponível colado em rede.

Also available glued on mesh.

También disponible enmallado.

Disponible également collé sur trame.

auch auf Netz geklebt erhältlich



97x97mm

GRÉS VIDRADO . GLAZED VITRIFIED TILES
GRÉS VIDRIADO . GRÉS ÉMAILLÉ . GLASIERTES STEINZEUG



PP 427 • **uni cereja**
mate . mat . matt • 6 mm
II / U2

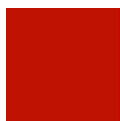

PP 426 • **uni vermelho**
mate . mat . matt • 6 mm
II / U2



PP 253 • **uni papoila**
mate . mat . matt • 6 mm
II / U2



PP 133 • **uni pergamon**
mate . mat . matt • 6 mm
IV / U3

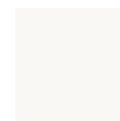

PP 190 • **uni cristal**
mate . mat . matt • 6 mm
IV / U3



PP 124 • **uni prata**
mate . mat . matt • 6 mm
IV / U3



PP 407 • **uni névoa**
mate . mat . matt • 6 mm
IV / U3



PP 415 • **uni caqui**
mate . mat . matt • 6 mm
II / U2



PP 1 • **uni gelo**
mate . mat . matt • 6 mm
IV / U3



PP 160 • **uni pérola**
mate . mat . matt • 6 mm
IV / U3



PP 403 • **uni cappuccino**
mate . mat . matt • 6 mm
III / U2S



PP 194 • **uni bege**
mate . mat . matt • 6 mm
III / U2S



PP 134 • **uni ouro**
mate . mat . matt • 6 mm
II / U2



PP 129 • **uni caramelo**
mate . mat . matt • 6 mm
II / U2



PP 404 • **uni salmão**
mate . mat . matt • 6 mm
III



PP 409 • **uni ocre**
mate . mat . matt • 6 mm
III / U2S



PP 333 • **uni sol**
mate . mat . matt • 6 mm
IV / U3



PP 239 • **uni tangerina**
mate . mat . matt • 6 mm
II



PP 428 • **uni fénix**
mate . mat . matt • 6 mm
III / U2S



PP 141 • **uni gema**
mate . mat . matt • 6 mm
III / U2S



PP 412 • **uni trevo**
mate . mat . matt • 6 mm
III / U2S



PP 135 • **uni menta**
mate . mat . matt • 6 mm
II / U2



PP 136 • **uni turquesa**
mate . mat . matt • 6 mm
IV / U3



PP 417 • **uni jade**
mate . mat . matt • 6 mm
II / U2



PP 416 • **uni tropical**
mate . mat . matt • 6 mm
II / U2



PP 420 • **uni navy**
mate . mat . matt • 6 mm
II / U2



PP 421 • **uni marine**
mate . mat . matt • 6 mm
II / U2



PP 422 • **uni lavanda**
mate . mat . matt • 6 mm
III / U2S



PP 423 • **uni indigo**
mate . mat . matt • 6 mm
II / U2



PP 151 • **uni agapante**
mate . mat . matt • 6 mm
II / U2



PP 401 • **uni ébano**
mate . mat . matt • 6 mm
II / U2



PP 121 • **uni carvão**
mate . mat . matt • 6 mm
I



PP 189 • **uni metal**
mate . mat . matt • 6 mm
I



PP 122 • **uni estanho**
mate . mat . matt • 6 mm
II / U2



PP 406 • **uni zinco**
mate . mat . matt • 6 mm
IV / U3



PP 191 • **uni papiro**
mate . mat . matt • 6 mm
IV / U3



PP 545 • **uni creme**
mate . mat . matt • 6 mm
III



PP 126 • **uni chocolate**
mate . mat . matt • 6 mm
I



PP 192 • **uni cacau**
mate . mat . matt • 6 mm
I



PP 127 • **uni moka**
mate . mat . matt • 6 mm
II / U2



PP 405 • **uni cotto**
mate . mat . matt • 6 mm
II / U2



PP 131 • **uni baunilha**
mate . mat . matt • 6 mm
II / U2S



PP 130 • **uni amêndoa**
mate . mat . matt • 6 mm
II / U2



PP 156 • **uni papaia**
mate . mat . matt • 6 mm
II / U2



PP 157 • **uni meloa**
mate . mat . matt • 6 mm
III / U2S



PP 140 • **uni lima**
mate . mat . matt • 6 mm
III / U2S



PP 414 • **uni musgo**
mate . mat . matt • 6 mm
III / U2S



PP 411 • **uni grama**
mate . mat . matt • 6 mm
III / U2S



PP 410 • **uni maçã**
mate . mat . matt • 6 mm
IV / U3



PP 413 • **uni limonete**
mate . mat . matt • 6 mm
IV / U3



PP 418 • **uni mineral**
mate . mat . matt • 6 mm
III / U2S



PP 198 • **uni céu**
mate . mat . matt • 6 mm
II / U2



PP 137 • **uni lago**
mate . mat . matt • 6 mm
II / U2



PP 419 • **uni safira**
mate . mat . matt • 6 mm
III / U2S



PP 199 • **uni água**
mate . mat . matt • 6 mm
III / U2S



PP 424 • **uni purpura**
mate . mat . matt • 6 mm
II / U2



PP 152 • **uni alfazema**
mate . mat . matt • 6 mm
III / U2S



PP 425 • **uni beringela**
mate . mat . matt • 6 mm
II / U2

97x97mm

Também disponível colado em rede.
Also available glued on mesh.
También disponible enmallado.
Disponible également collé sur trame.
auch auf Netz geklebt erhältlich

ACABAM ESPECIAL

SPECIAL FINISHING
ACABAMIENTOS ESPECIALES
FINITIONS PARTICULIÈRES
SPEZIELLE OBERFLÄCHEN

MENTOS AIS



U4 P4+

PAVIMENTO
FLOOR TILES
PAVIMENTO
CARREAUX
BODENFLIESEN

ESTRUTURADO
STRUCTURED
ESTRUTURADO
STRUCTURÉ
STRUKTURIERT

ANTIDERRAPANTE
ANTI-SLIP
ANTIDERRAPANTE
ANTIDÉRAPANTE
TRITTSICHER

ACABAMENTO MATE ESPESSURA INTERMÉDIA
MATT MEDIUM THICKNESS
ACABADO MATE ESPESOR INTERMEDIO
FINITION MATE ÉPAISSEUR MOYENNE
MITTLERE STÄRKE

U4 P4S

ACABAMENTO MATE FORTE ESPESSURA
MATT EXTRA THICKNESS
ACABADO MATE FUERTE ESPESOR
FINITION MATE FORTE ÉPAISSEUR
MATT ÜBERSTÄRKE



PAVIMENTO
FLOOR TILES
PAVIMENTO
CARREAUX
BODENFLIESEN

ANTIDERRAPANTE
ANTI-SLIP
ANTIDERRAPANTE
ANTIDÉRAPANTE
TRITTSICHER

GRÉS PORCELÁNICO TÉCNICO
HOMOGENEOUS TECHNICAL PORCELAIN TILES
GRÉS PORCELÁNICO TÉCNICO
GRÉS CÉRAME TECHNIQUE
TECHNIK UNGLASIERTES FEINSTEINZEUG

GRÉS VIDRADO
GLAZED VITRIFIED TILES
GRÉS VIDRIADO
GRÉS ÉMAILLÉ
GLASIERTES STEINZEUG

TACTILE 297x297mm

GRÉS PORCELÂNICO TÉCNICO . HOMOGENEOUS TECHNICAL PORCELAIN TILES

GRÉS PORCELÂNICO TÉCNICO . GRÉS CÉRAME TECHNIQUE . TECHNIK UNGLASIERTES FEINSTEINZEUG



PGSTP452V . UNI PRETO 297x297mm
PGSTP25V . UNI ESTANHO 297x297mm
PGSTP4V . UNI PÉROLA 297x297mm
PGSTB25V . UNI ESTANHO 297x297mm
PG25 . UNI ESTANHO 297x297mm



14

TACTILE 297x297mm

GRÉS PORCELÂNICO TÉCNICO . HOMOGENEOUS TECHNICAL PORCELAIN TILES

GRÉS PORCELÂNICO TÉCNICO . GRÉS CÉRAME TECHNIQUE . TECHNIK UNGLASIERTES FEINSTEINZEUG



R10B



PGSTP452V . UNI PRETO 297x297mm
PGSTB452V . UNI PRETO 297x297mm
PGSTB4V . UNI PÉROLA 297x297mm
PG4 . UNI PÉROLA 297x297mm



PGSTP452V • uni preto • R10B
 mate . mat . matt



PGSTP25V • uni estanho • R10B
 mate . mat . matt



PGSTP4V • uni pérola • R10B
 mate . mat . matt

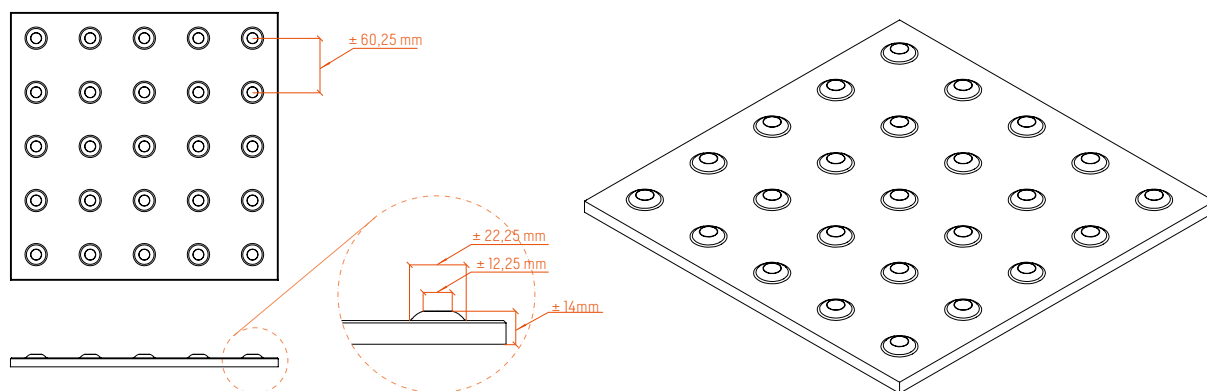

PGSTB452V • uni preto • R10B
 mate . mat . matt



PGSTB25V • uni estanho • R10B
 mate . mat . matt



PGSTB4V • uni pérola • R10B
 mate . mat . matt

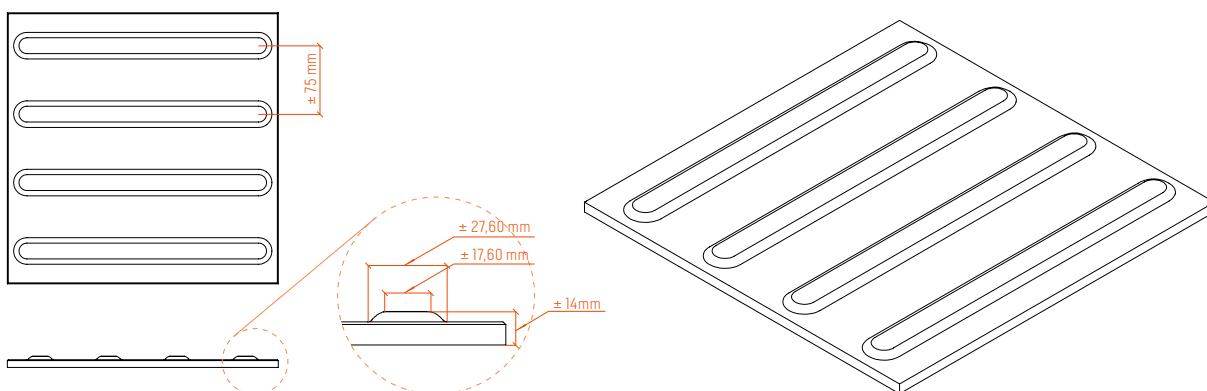



PGS 471EN • uni preto R11C • 10,5 mm • U4 P4

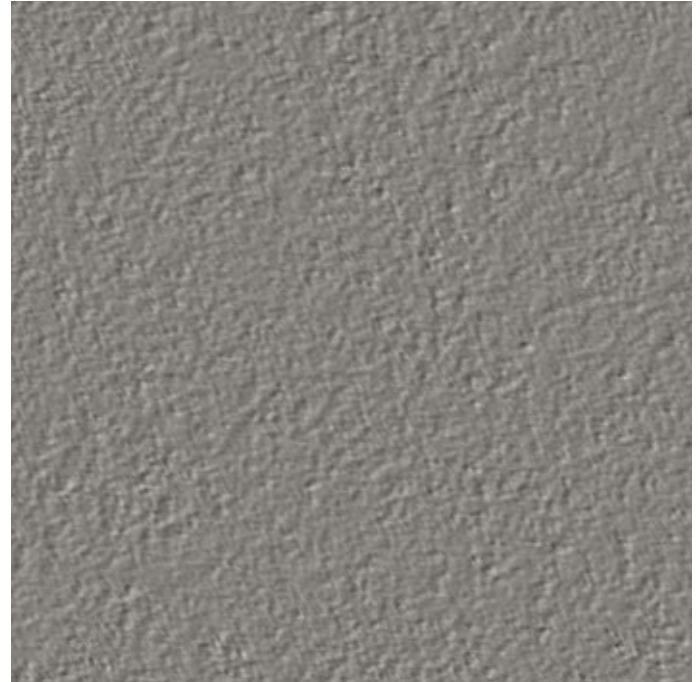

PGS 183EN • uni estanho R11C • 10,5 mm • U4 P4

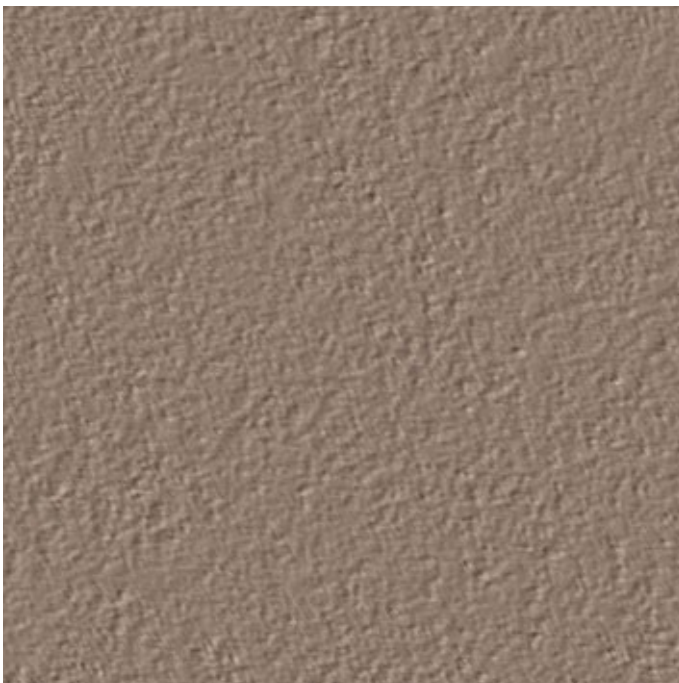

PGS 180EN • uni moka R11C • 10,5 mm • U4 P4



PGS 430EN • **prata** R11C • 10,5 mm • U4 P4



PGS 177EN • **uni gelo** R11C • 10,5 mm • U4 P4

ESTRUTURADO Versão 3. STRUCTURED Version 3
ESTRUCTURADO Versión 3. STRUCTURE Version 3. STRUKTURIERT Version 3

92

297x597mm sem cristalina . without crystalline . sin cristalino . sans cristaline . ohne Kristallin

GRÉS PORCELÂNICO TÉCNICO . HOMOGENEOUS TECHNICAL PORCELAIN TILES

GRÉS PORCELÂNICO TÉCNICO . GRÈS CÉRAME TECHNIQUE . TECHNIK UNGLASIERTES FEINSTEINZEUG



PGS430EN . UNI PRATA R11C 597x597 mm
PGS183EN . UNI Estanho R11C 597x597 mm



PGS 520EN • **uni preto** R11C • 9,2 mm • U4 P3

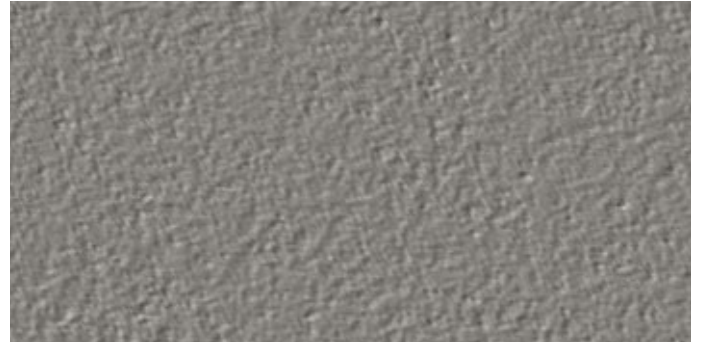

PGS 207EN • **uni estanho** R11C • 9,2 mm • U4 P3



PGS 280EN • **prata** R11C • 9,2 mm • U4 P3

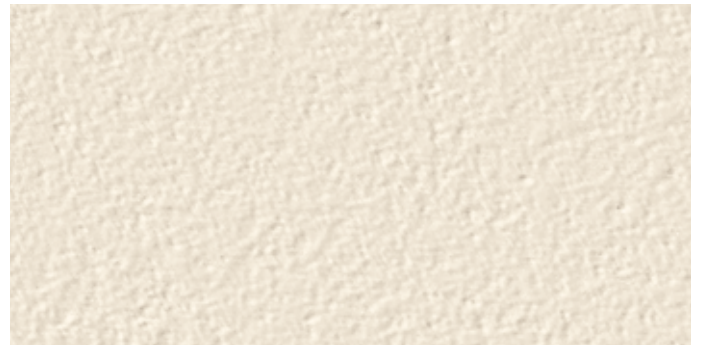

PGS 265EN • **uni gelo** R11C • 9,2 mm • U4 P3

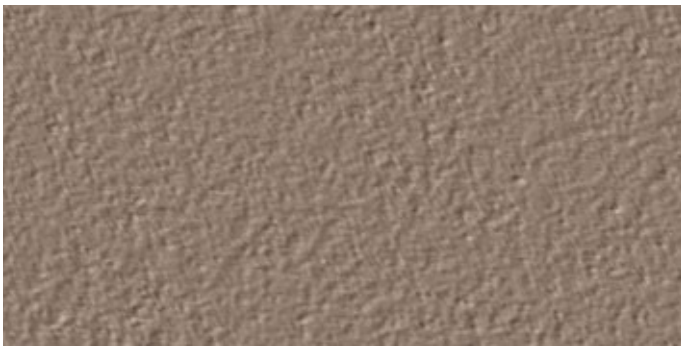

PGS 276EN • **uni moka** R11C • 9,2 mm • U4 P3



PG 67E • **uni pergamon** R11C • 8,3 mm
U4 P4



PG 23E • **uni carvão** R11C • 8,3 mm
U4 P4



PG 452E • **uni preto** R11C • 8,3 mm
U4 P4



PG 25E • **uni estanho** R11C • 8,3 mm
U4 P4



PG 26E • **uni prata** R11C • 8,3 mm
U4 P4



PG 244E • **fino carvão** R11C • 8,3 mm
U4 P4

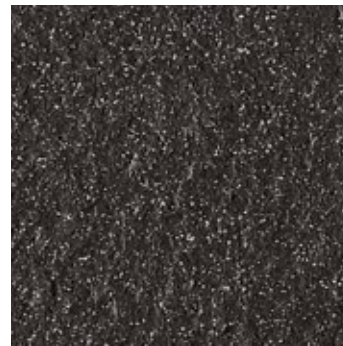

PG 353E • **fino preto** R11C • 8,3 mm
U4 P4



PG 28E • **fino estanho** R11C • 8,3 mm
U4 P4



PG 3E • **uni gelo** R11C • 8,3 mm
U4 P4



PG 4E • **uni pérola** R11C • 8,3 mm



PG 12E • **uni moka** R11C • 8,3 mm
U4 P4



PG 18E • **uni baunilha** R11C • 8,3 mm
U4 P4



PG 33E • **fino gelo** R11C • 8,3 mm
U4 P4



PG 355E • **fino pérola** R11C • 8,3 mm



PG 15E • **fino moka** R11C • 8,3 mm
U4 P4



PG 21E • **fino baunilha** R11C • 8,3 mm
U4 P4

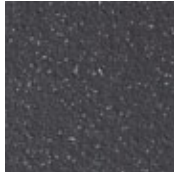

fino preto R11B
 PG 511EB • 8,3 mm
 U4 P4



fino estanho R11B
 PG 205EB • 8,3 mm
 U4 P4



fino zinco R11B
 PG 510EB • 8,3 mm
 U4 P4

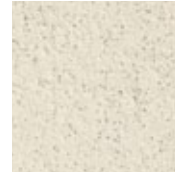

fino gelo R11B
 PG 203EB • 8,3 mm
 U4 P4



fino moka R11B
 PG 202EB • 8,3 mm
 U4 P4



PG511EB . FINO PRETO R11B 147x147 mm
 PG205EB . FINO ESTANHO R11B 147x147 mm
 PG203EB . FINO GELO R11B 147x147 mm
 PG86 . UNI ESTANHO 97x297mm
 PG475 . UNI PRETO 147x147mm
 PG44 . UNI ESTANHO 147x147mm
 PG46 . UNI GELO 147x147mm



PG511EB . FINO PRETO R11B 147x147 mm
 PG205EB . FINO ESTANHO R11B 147x147 mm
 PG203EB . FINO GELO R11B 147x147 mm

DIN 51130 ANTIDERRAPANTE . ANTI-SLIP
ANTIDERRAPANTE . ANTIDÉRAPANTE . TRITTSICHER



14
83

297x297mm

GRÉS PORCELÁNICO TÉCNICO . HOMOGENEOUS TECHNICAL PORCELAIN TILES
GRÉS PORCELÁNICO TÉCNICO . GRÉS CÉRAME TECHNIQUE . TECHNIK UNGLASIERTES FEINSTEINZEUG



PG23U . UNI CARVÃO 297x297 mm
PG244U . FINO CARVÃO 297x297 mm
PG85 . UNI CARVÃO 97x297 mm
PG88 . UNI GELO 97x297 mm



PG23U . UNI CARVÃO 297x297 mm
PG244U . FINO CARVÃO 297x297 mm
PG85 . UNI CARVÃO 97x297 mm
PG88 . UNI GELO 97x297 mm



uni carvão R12C
PG 23U • 14 mm
PG 23X • 8,3 mm

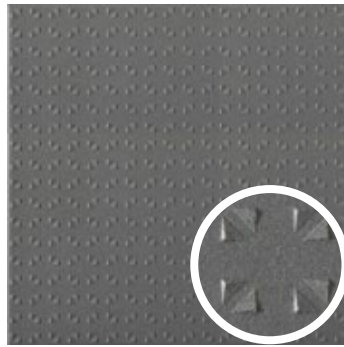

uni metal R12C
PG 24X • 8,3 mm

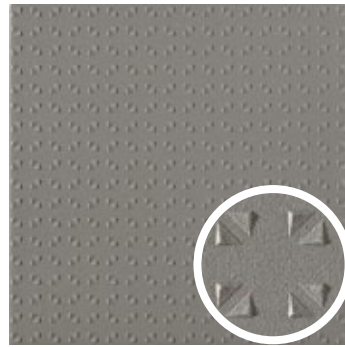

uni estanho R12C
PG 25U • 14mm • U4P4S
PG 25X • 8,3 mm

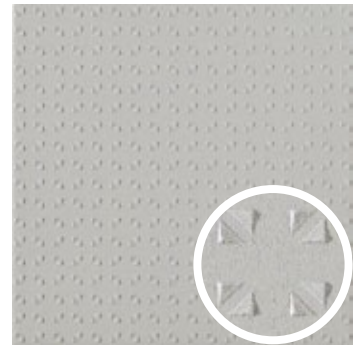

uni prata R12C
PG 26X • 8,3 mm

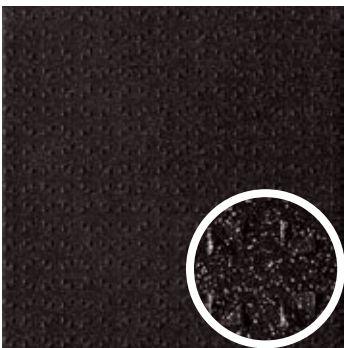

fino carvão R12C
PG 244U • 14mm
PG 244X • 8,3 mm

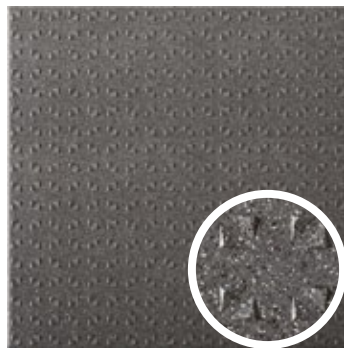

fino metal R12C
PG 27X • 8,3 mm

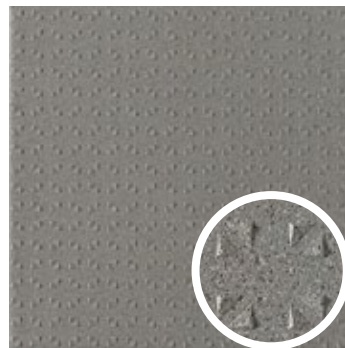

fino estanho R12C
PG 28U • 14mm • U4P4S
PG 28X • 8,3 mm



fino prata R12C
PG 29X • 8,3 mm

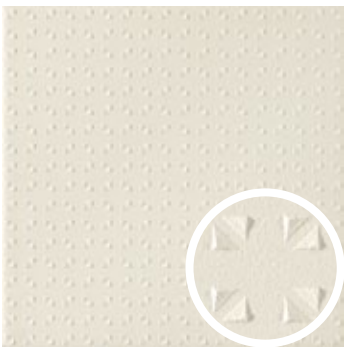

uni gelo R12C
PG 3U • 14mm • U4 P4S
PG 3X • 8,3 mm



uni pérola R12C
PG 4U • 14mm
PG 4X • 8,3 mm

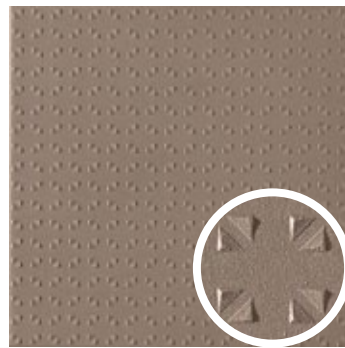

uni moka R12C
PG 12X • 8,3 mm • U4P4S



uni bege R12C
PG 82X • 8,3 mm



fino gelo R12C
PG 33U • 14mm • U4P4S
PG 33X • 8,3 mm



fino pérola R12C
PG 355U • 14mm
PG 355X • 8,3 mm

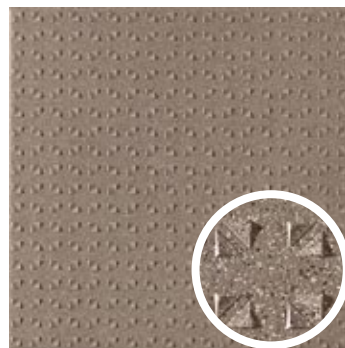

fino moka R12C
PG 15X • 8,3 mm • U4P4S



fino bege R12C
PG 83X • 8,3 mm

DIN 51130 ANTIDERRAPANTE . ANTI-SLIP
 ANTIDERRAPANTE . ANTIDÉRAPANTE . TRITTSICHER



12
8,3

197x197mm

GRÉS PORCELÂNICO TÉCNICO . HOMOGENEOUS TECHNICAL PORCELAIN TILES
 GRÉS PORCELÂNICO TÉCNICO . GRÉS CÉRAME TECHNIQUE . TECHNIK UNGLASIERTES FEINSTEINZEUG

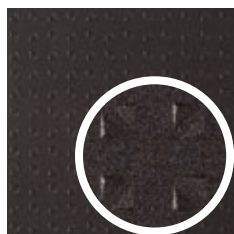

uni carvão R12C
 PG 66X • 8,3 mm • U4 P4
 PG 66Y • 12 mm • U4 P4S

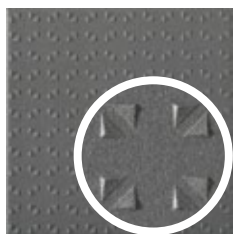

uni metal R12C
 PG 96X • 8,3 mm • U4 P4

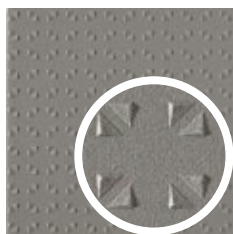

uni estanho R12C
 PG 52X • 8,3 mm • U4 P4
 PG 52Y • 12 mm • U4 P4S

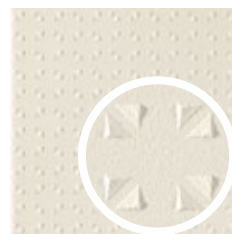

uni gelo R12C
 PG 2X • 8,3 mm • U4 P4
 PG 2Y • 12 mm • U4 P4S



uni pérola R12C
 PG 62X • 8,3 mm
 PG 62Y • 12 mm • U4 P4S

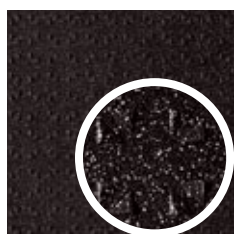

fino carvão R12C
 PG 243X • 8,3 mm • U4 P4
 PG 243Y • 12 mm • U4 P4S

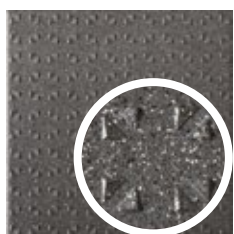

fino metal R12C
 PG 219X • 8,3 mm

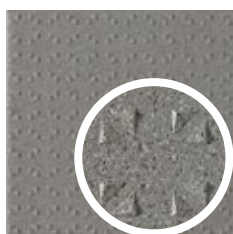

fino estanho R12C
 PG 104X • 8,3 mm • U4 P4
 PG 104Y • 12 mm • U4 P4S



fino gelo R12C
 PG 105X • 8,3 mm • U4 P4
 PG 105Y • 12 mm • U4 P4S



fino pérola R12C
 PG 525X • 8,3 mm
 PG 525Y • 12 mm • U4 P4S



uni papiro R12C
 PG 58X • 8,3 mm • U4 P4

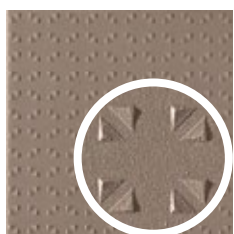

uni moka R12C
 PG 53X • 8,3 mm • U4 P4
 PG 53Y • 12 mm • U4 P4S

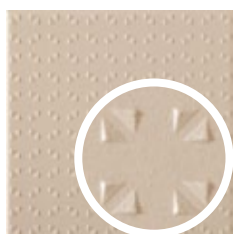

uni bege R12C
 PG 54X • 8,3 mm • U4 P4

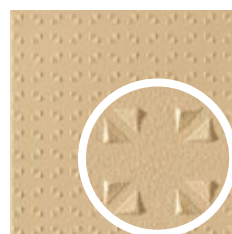

uni baunilha R12C
 PG 51X • 8,3 mm • U4 P4
 PG 51Y • 12 mm • U4 P4S

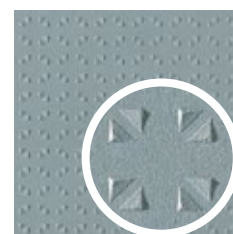

uni mineral R12C
 PG 363X • 8,3 mm



fino papiro R12C
 PG 483X • 8,3 mm

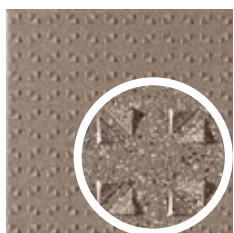

fino moka R12C
 PG 102X • 8,3 mm • U4 P4
 PG 102Y • 12 mm • U4 P4S



fino bege R12C
 PG 254X • 8,3 mm • U4 P4

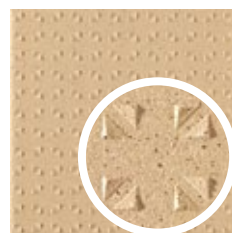

fino baunilha R12C
 PG 103X • 8,3 mm • U4 P4
 PG 103Y • 12 mm • U4 P4S

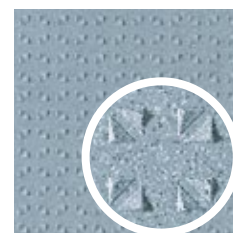

fino mineral R12C
 PG 389X • 8,3 mm



DIN 51130 ANTIDERRAPANTE . ANTI-SLIP
 ANTIDERRAPANTE . ANTIDERAPANTE . TRITTSICHER

147x147mm

12 8,3

GRÉS PORCELÂNICO TÉCNICO . HOMOGENEOUS TECHNICAL PORCELAIN TILES
 GRÉS PORCELÁNICO TÉCNICO . GRÉS CÉRAME TECHNIQUE . TECHNIK UNGLASIERTES FEINSTEINZEUG



uni carvão R12C
 PG 43X • 8,3 mm • U4 P4
 PG 43Y • 12 mm • U4 P4S

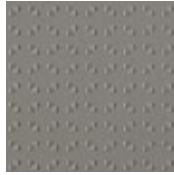

uni estanho R12C
 PG 44X • 8,3 mm • U4 P4
 PG 44Y • 12 mm • U4 P4S

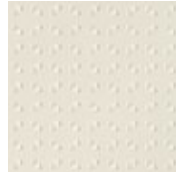

uni gelo R12C
 PG 46X • 8,3 mm • U4 P4
 PG 46Y • 12 mm • U4 P4S



uni pérola R12C
 PG 505X • 8,3 mm
 PG 505Y • 12 mm



uni moka R12C
 PG 47X • 8,3 mm • U4 P4
 PG 47Y • 12 mm • U4 P4S



uni baunilha R12C
 PG 48X • 8,3 mm • U4 P4
 PG 48Y • 12 mm • U4 P4S



PG52X . UNI ESTANHO 197x197 mm
 PG52G . UNI ESTANHO 97x197 mm

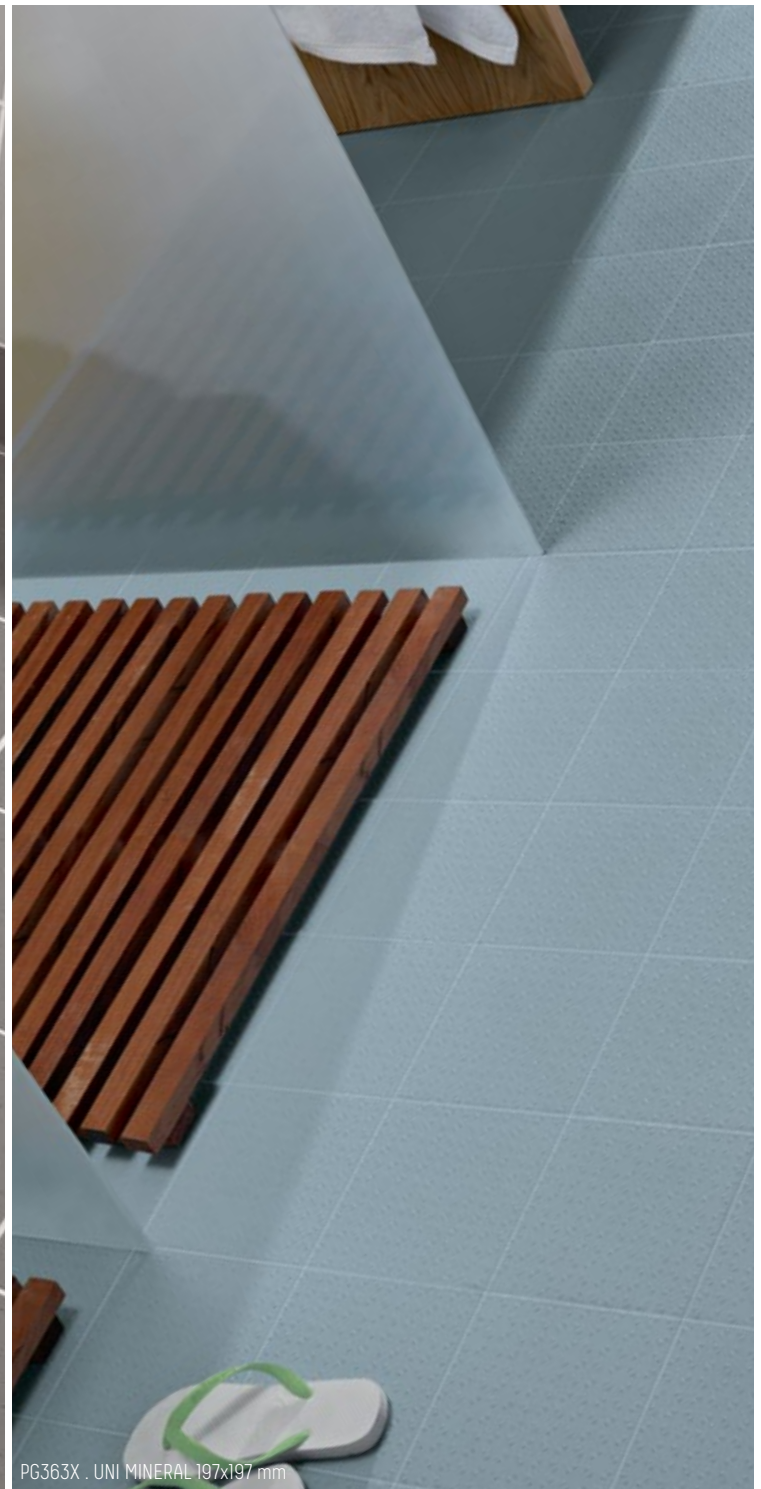

PG363X . UNI MINERAL 197x197 mm

DIN 51130 ANTIDERRAPANTE . ANTI-SLIP
ANTIDERRAPANTE . ANTIDÉRAPANTE . TRITTSICHER



12- **197x197mm**

GRÉS PORCELÁNICO TÉCNICO . HOMOGENEOUS TECHNICAL PORCELAIN TILES
GRÉS PORCELÁNICO TÉCNICO . GRÉS CÉRAME TECHNIQUE . TECHNIK UNGLASIERTES FEINSTEINZEUG



PG58YR . UNI PAPIRO R13 197x197mm

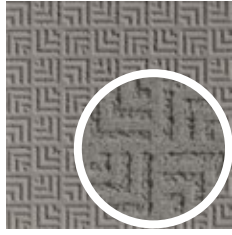

uni estanho R13
PG 52YR • 12 mm • U4 P4S

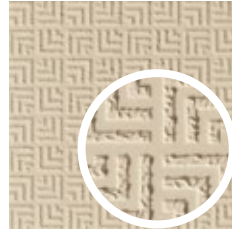

uni papiro R13
PG 58YR • 12 mm • U4 P4S

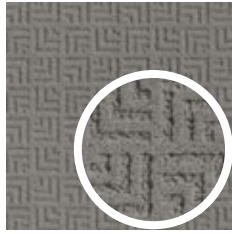

fino estanho R13
PG 104YR • 12 mm • U4 P4S

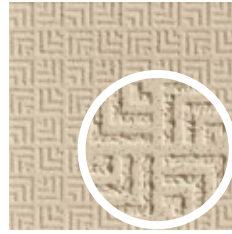

fino papiro R13
PG 483YR • 12 mm • U4 P4S



PG58YR · UNI PAPIRO R13 197x197mm

ANTIDERRAPANTE . ANTI-SLIP
ANTIDERRAPANTE . ANTIDERRAPANTE . TRITTSICHER

83. **197x197mm . 97x97 mm**

GRÉS VIDRADO FINO ANTIDERRAPANTE . FINO ANTI-SLIP GLAZED VITRIFIED TILES
GRÉS VIDRIADO FINO ANTIDERRAPANTE . FINO GRÉS ÉMAILLÉ ANTIDERRAPANT . GLASIERTES STEINZEUG FINO TRITTSICHER



PP50 . UNI PRATA 197x197 mm
PP50JI . UNI PRATA 25x197 mm
PP50JE . UNI PRATA 25x197 mm
PP240X . FINO METAL 97x97 mm
PP219G . FINO METAL 97x197 mm
PP219GI . FINO METAL 25x97 mm
PP219GE . FINO METAL 25x97 mm

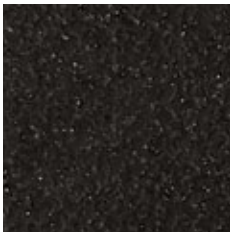

fino carvão R11B

PP 243X • 197x197 • 8,3 mm
PP 213X • 97x97 • 8,3 mm

II

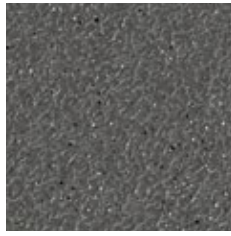

fino metal R11B

PP 219X • 197x197 • 8,3 mm
PP 240X • 97x97 • 8,3 mm

III

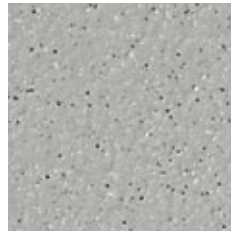

fino prata R11B

PP 220X • 197x197 • 8,3 mm
PP 241X • 97x97 • 8,3 mm

IV

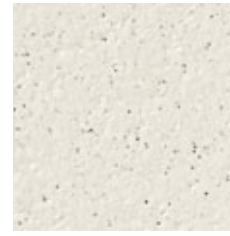

fino gelo R11B

PP 105X • 197x197 • 8,3 mm
PP 125X • 97x97 • 8,3 mm

IV

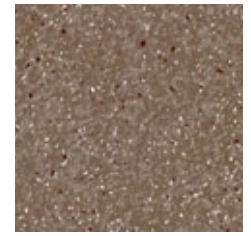

fino moka R11B

PP 102X • 197x197 • 8,3 mm
PP 128X • 97x97 • 8,3 mm

III

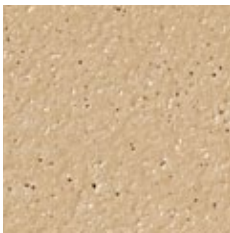

fino baunilha R11B

PP 103X • 197x197 • 8,3 mm
PP 132X • 97x97 • 8,3 mm

IV



fino meloa R11B

PP 216X • 197x197 • 8,3 mm
PP 236X • 97x97 • 8,3 mm

IV

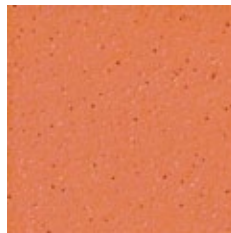

fino tangerina R11B

PP 218X • 197x197 • 8,3 mm
PP 238X • 97x97 • 8,3 mm

IV

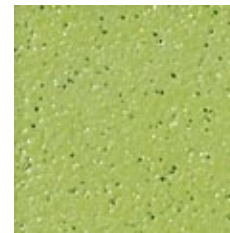

fino lima R11B

PP 217X • 197x197 • 8,3 mm
PP 237X • 97x97 • 8,3 mm

IV

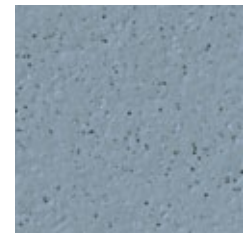

fino céu R11B

PP 442X • 197x197 • 8,3 mm
PP 443X • 97x97 • 8,3 mm

IV

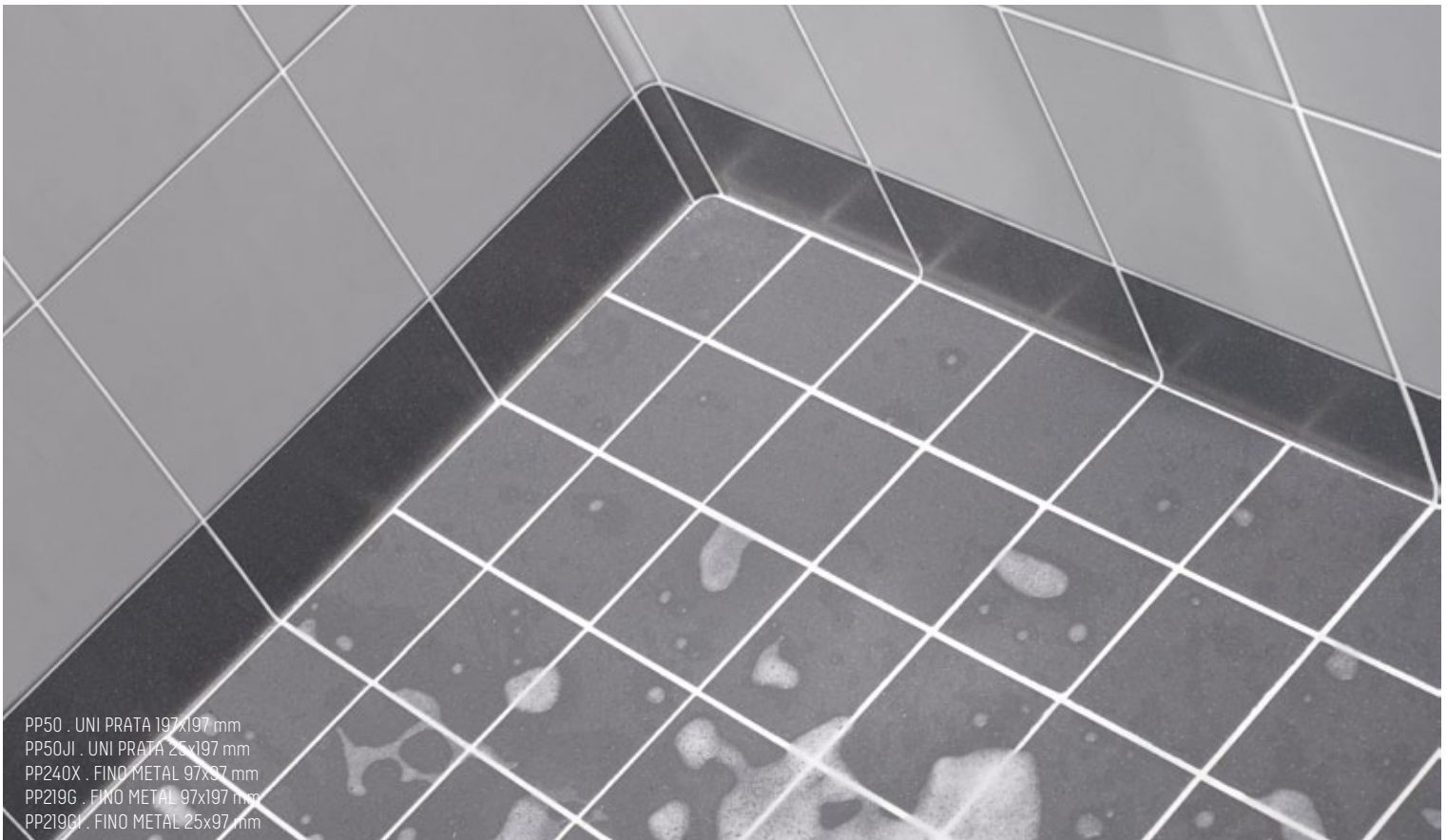

PP50 . UNI PRATA 197x197 mm
PP50JI . UNI PRATA 25x197 mm
PP240X . FINO METAL 97x97 mm
PP219G . FINO METAL 97x197 mm
PP219GI . FINO METAL 25x97 mm



97x197 mm

Rodapé prensado curvo mate . Cove base matt . Rodapié prensado curvo mate
Plinthe à gorge mat . Hohlekehlssockel matt
VER . SEE . VOIR . SIEHE REF. PG. 183



GI



GE

25x97 mm

Ângulo interno e ângulo externo para rodapé curvo 97x197 mm
Internal angle and external angle for cove base
Angulo interno y angulo externo para rodapié curvo
Angle intérieur et angle extérieur pour plinthe à gorge
Innenecken und Aussenecken für Hohlkehlssockel
VER . SEE . VOIR . SIEHE REF. PG. 183



U4 P4+
447x447 mm . 297x297mm

GRÉS PORCELÂNICO TÉCNICO . HOMOGENEOUS TECHNICAL PORCELAIN TILES
GRÉS PORCELÂNICO TÉCNICO . GRÉS CÉRAMÉ TECHNIQUE . TECHNIK UNGLASIERTES FEINSTEINZEUG

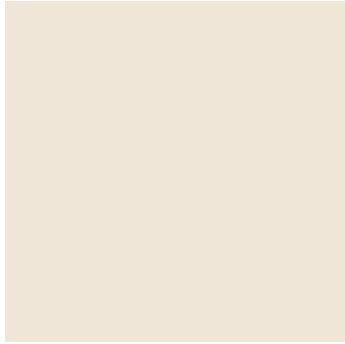

uni pergamon

PG67K • 297x297 mm • 11 mm
PG164K • 447x447 mm • 11 mm
R9A • U4 P4+



uni carvão

PG23K • 297x297 mm • 11 mm
PG165K • 447x447 mm • 11 mm
R9A • U4 P4+



uni estanho

PG25K • 297x297 mm • 11 mm
PG158K • 447x447 mm • 11 mm
R9A • U4 P4+



uni prata

PG26K • 297x297 mm • 11 mm
PG171K • 447x447 mm • 11 mm
R9A • U4 P4+



fino carvão

PG244K • 297x297 mm • 11 mm
PG245K • 447x447 mm • 11 mm
R9A • U4 P4+

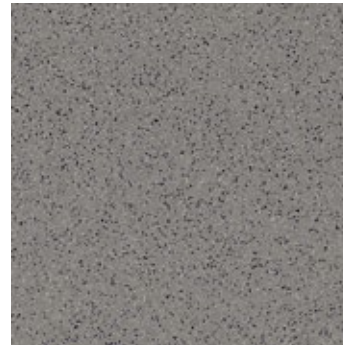

fino estanho

PG28K • 297x297 mm • 11 mm
PG159K • 447x447 mm • 11 mm
R9A • U4 P4+

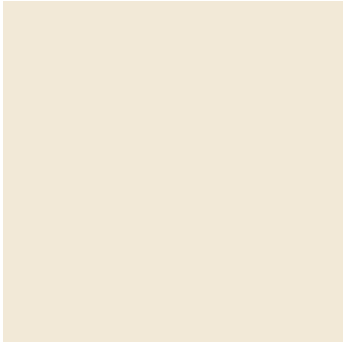

uni gelo

PG33K • 297x297 mm • 11 mm
PG167K • 447x447 mm • 11 mm
R9A • U4 P4+

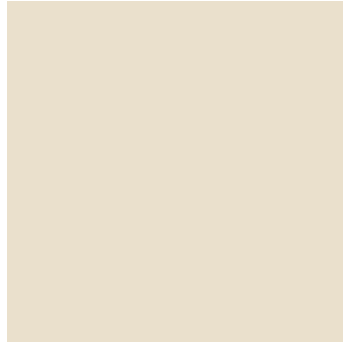

uni pérola

PG4K • 297x297 mm • 11 mm
PG524K • 447x447 mm • 11 mm
R9A



uni moka

PG12K • 297x297 mm • 11 mm
PG172K • 447x447 mm • 11 mm
R9A • U4 P4+



uni baunilha

PG18K • 297x297 mm • 11 mm
PG162K • 447x447 mm • 11 mm
R9A • U4 P4+



fino gelo

PG33K • 297x297 mm • 11 mm
PG169K • 447x447 mm • 11 mm
R9A • U4 P4+

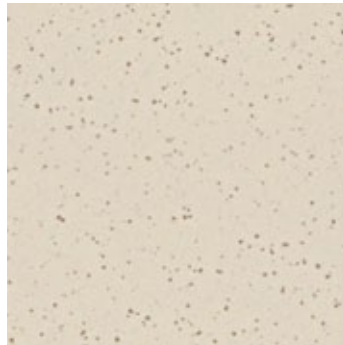

fino pérola

PG355K • 297x297 mm • 11 mm
PG526K • 447x447 mm • 11 mm
R9A



fino moka

PG15K • 297x297 mm • 11 mm
PG173K • 447x447 mm • 11 mm
R9A • U4 P4+



fino baunilha

PG21K • 297x297 mm • 11 mm
PG163K • 447x447 mm • 11 mm
R9A • U4 P4+

U4 P4S

297x297mm . 197x197 mm

GRÉS PORCELÂNICO TÉCNICO . HOMOGENEOUS TECHNICAL PORCELAIN TILES

GRÉS PORCELÂNICO TÉCNICO . GRÈS CÉRAME TECHNIQUE . TECHNIK UNGLASIERTES FEINSTEINZEUG

14

12

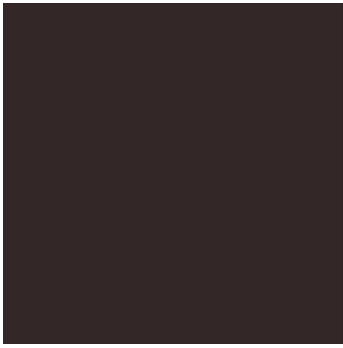

uni carvão

PG 23V • 297x297 mm • 14 mm
PG 66Z • 197x197 mm • 12 mm
R9A • U4 P4S



uni estanho

PG 25V • 297x297 mm • 14 mm
PG 52Z • 197x197 mm • 12 mm
R9A • U4 P4S

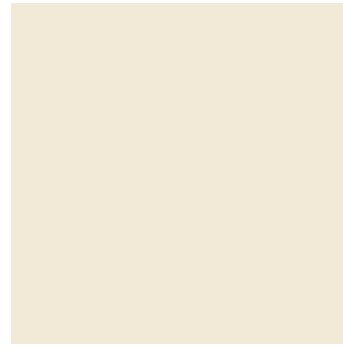

uni gelo

PG 3V • 297x297 mm • 14 mm
PG 2Z • 197x197 mm • 12 mm
R9A • U4 P4S

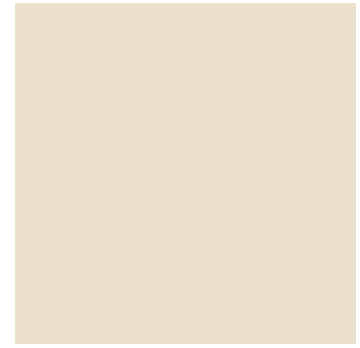

uni pérola

PG 4V • 297x297 mm • 14 mm
PG 62Z • 197x197 mm • 12 mm
R9A • U4 P4S



fino carvão

PG 244V • 297x297 mm • 14 mm
PG 243Z • 197x197 mm • 12 mm
R9A • U4 P4S

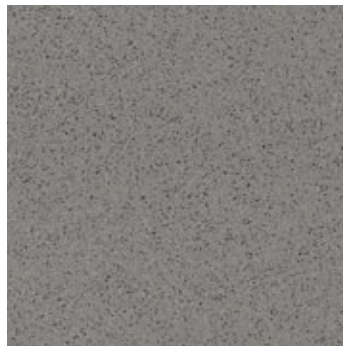

fino estanho

PG 28V • 297x297 mm • 14 mm
PG 104Z • 197x197 mm • 12 mm
R9A • U4 P4S



fino gelo

PG 33V • 297x297 mm • 14 mm
PG 105Z • 197x197 mm • 12 mm
R9A • U4 P4S

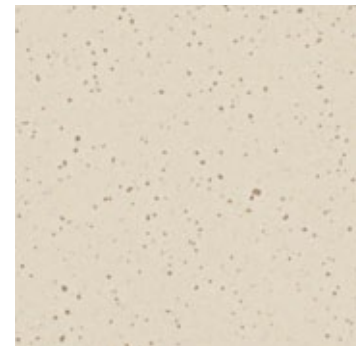

fino pérola

PG 355V • 297x297 mm • 14 mm
PG 525Z • 197x197 mm • 12 mm
R9A • U4 P4S



uni moka

PG 12V • 297x297 mm • 14 mm
PG 53Z • 197x197 mm • 12 mm
R9A • U4 P4S



uni baunilha

PG 18V • 297x297 mm • 14 mm
PG 51Z • 197x197 mm • 12 mm
R9A • U4 P4S

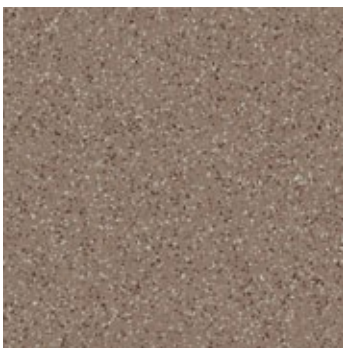

fino moka

PG 15V • 297x297 mm • 14 mm
PG 102Z • 197x197 mm • 12 mm
R9A • U4 P4S



fino baunilha

PG 21V • 297x297 mm • 14 mm
PG 103Z • 197x197 mm • 12 mm
R9A • U4 P4S



uni carvão
PG 43Z • 12 mm
R9A • U4 P4S



uni estanho
PG 44Z • 12 mm
R9A • U4 P4S

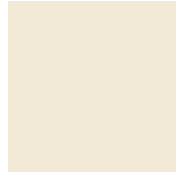

uni gelo
PG 46Z • 12 mm
R9A • U4 P4S



uni pérola
PG 505Z • 12 mm
R9A



uni moka
PG 47Z • 12 mm
R9A • U4 P4S



uni baunilha
PG 48Z • 12 mm
R9A • U4 P4S











PG51Z . UNI BAUNILHA
PG53Z . UNI MOKA

INFOR TÉCN

















TECHNICAL INFORMATION
INFORMACIÓN TÉCNICA
INFORMATION TECHNIQUE
TECHNISCHE INFORMATION



ARMACÇÃO
ICA



















tipo de produto disponível type of product available tipo de producto disponible type de produit disponible Erhältliche Produkte								
formatos . sizes . formatos formats . Formate (mm)	147x147	197x197	97x297	197x597	297x597	25x197	25x197	31x197
espessura . thickness . espesor épaisseur . Stärke (mm)	6,5	7	8,3	11,6	11,9	7,2	7,2	7
letras . letters . letras . lettres . Buchstaben	-	-	-	-	-	JI	JE	T

uni cereja		PC 358	PC 392	PC 361				PC 358T
uni vermelho	PC 398	PC 385						PC 385T
uni papoila		PC 387	PC 393	PC 472	PC 429			PC 387T
uni pergamon	PC 49	PC 60	PC 91	PC 479	PC 288	PC 60JI	PC 60JE	PC 60T
uni cristal	PC 201	PC 61	PC 113	PC 330	PC 281	PC 61JI	PC 61JE	PC 61T
uni ébano		PC 400						PC 400T
uni carvão	PC 43	PC 66	PC 85	PC 327	PC 269	PC 66JI	PC 66JE	PC 66T
uni metal		PC 96	PC 225	PC 326				PC 96T
uni estanho	PC 44	PC 52	PC 86			PC 52JI	PC 52JE	PC 52T
uni zinco		PC 367						PC 367T
uni prata	PC 45	PC 50	PC 87			PC 50JI	PC 50JE	PC 50T
uni névoa		PC 368						PC 368T
uni caqui		PC 375						PC 375T
uni gelo	PC 46	PC 2	PC 88	PC 329	PC 265	PC 2JI	PC 2JE	PC 2T
uni pérola		PC 62						PC 62T
uni papiro		PC 58						PC 58T
uni creme		PC 554						
uni chocolate		PC 95						PC 95T
uni cacau		PC 97						PC 97T
uni moka	PC 47	PC 53	PC 89			PC 53JI	PC 53JE	PC 53T
uni capuccino		PC 364						PC 364T
uni bege		PC 54						PC 54T
uni ouro		PC 99						PC 99T
uni caramelo		PC 93						PC 93T
uni salmão		PC 365						PC 365T
uni cotto		PC 366						PC 366T
uni baunilha	PC 48	PC 51	PC 90			PC 51JI	PC 51JE	PC 51T
uni amêndoa		PC 63						PC 63T
uni papaia		PC 149		PC 323				PC 149T
uni meloa		PC 150	PC 222					PC 150T
uni ocre	PC 477	PC 370						PC 370T
uni sol		PC 119						PC 119T
uni tangerina	PC 286	PC 118	PC 224					PC 118T
uni fénix		PC 386						PC 386T
uni gema	PC 283	PC 143	PC 312	PC 362				PC 143T
uni lima	PC 282	PC 142	PC 223	PC 324	PC 290			PC 142T
uni musgo		PC 374						PC 374T
uni grama		PC 371						PC 371T
uni maçã	PC 399	PC 356						PC 356T
uni limonete		PC 373						PC 373T
uni trevo		PC 372						PC 372T
uni menta		PC 55						PC 55T
uni turquesa	PC 301	PC 59						PC 59T
uni jade		PC 377						PC 377T
uni tropical	PC 397	PC 376	PC 391					PC 376T
uni mineral		PC 363						PC 363T
uni céu		PC 116	PC 388					PC 116T
uni lago	PC 299	PC 115		PC 331				PC 115T
uni safira	PC 396	PC 379						PC 379T
uni água		PC 65						PC 65T
uni navy	PC 395	PC 380						PC 380T
uni marine		PC 381						PC 381T
uni lavanda		PC 382						PC 382T
uni indigo	PC 476	PC 357	PC 390	PC 360				PC 357T
uni agapante		PC 144						PC 144T
uni púrpura		PC 383						PC 383T
uni alfazema		PC 145						PC 145T
uni beringela		PC 384						PC 384T

tipo de produto disponível type of product available tipo de producto disponible type de produit disponible Erhältliche Produkte	HEXAGON mate . mat . matt R9A	mate . mat . matt R9A	mate . mat . matt R9A	mate . mat . matt R9A	mate . mat . matt R9A	mate . mat . matt R9A	mate . mat . matt R9A	mate . mat . matt R9A	mate . mat . matt R9A	mate . mat . matt R9A	mate . mat . matt R9A	mate . mat . matt R9A	mate . mat . matt R9A	macio . honed . macio . adoucie . weich	macio . honed . macio . adoucie . weich	macio . honed . macio . adoucie . weich
																
formatos . sizes . formatos formats . Formate (mm)	97x97	97x97 *	147x147	197x197	97x297	297x297	447x447	297x597	597x597	447x890	597x1190	890x890	297x297	447x447	597x597	
espessura . thickness . espesor . épaisseur . Stärke (mm)	8,3	8,3	8,3	8,3	8,3	8,3	9,2	9,2	10,5	10,5	10,5	10,5	8,3	9,2	10,5	
letras . letters . letras . lettres . Buchstaben	-	-	-	-	-	-	-	-	-	-	-	-	M	M	M	

uni papoila						PG 68RT			PG 431RT					PG 68M		PG 431M
uni pergamon		PG 133	PG 49	PG 60	PG 91	PG 67	PG 164							PG 67M	PG 164M	
uni cristal						PG 92RT			PG 277RT					PG 92M		PG 277M
uni carvão		PG 121	PG 43	PG 66	PG 85	PG 23	PG 165	PG 269	PG 175	PG 469RT				PG 23M	PG 165M	PG 175M
uni preto	PGH 408	PG 408	PG 475	PG 369		PG 452			PG 471					PG 452M		PG 471M
uni metal	PGH 189	PG 189		PG 96		PG 24		PG 268	PG 263	PG 470RT	PG 502RT	PG 507RT		PG 24M		PG 263M
uni estanho	PGH 122	PG 122	PG 44	PG 52	PG 86	PG 25	PG 158	PG 207	PG 183					PG 25M	PG 158M	PG 183M
uni zinco	PGH 406	PG 406		PG 367		PG 450								PG 450M		
uni prata		PG 124	PG 45	PG 50	PG 87	PG 26	PG 171	PG 280	PG 430					PG 26M	PG 171M	PG 430M
uni névoa						PG 451								PG 451M		
uni caqui						PG 447								PG 447M		
uni gelo		PG 1	PG 46	PG 2	PG 88	PG 3	PG 167	PG 265	PG 177	PG 466RT	PG 503RT	PG 506RT		PG 3M	PG 167M	PG 177M
uni pérola	PGH 160	PG 160	PG 505	PG 62	PG 305	PG 4	PG 524	PG 517	PG 484					PG 4M	PG 524M	PG 484M
uni papiro		PG 191		PG 58		PG 5								PG 5M		
uni creme		PG 545				PG 544		PG 548	PG 551					PG 544M		PG 551M
uni chocolate		PG 126		PG 95		PG 14		PG 292	PG 278					PG 14M		PG 278M
uni cacau				PG 97		PG 78								PG 78M		
uni moka	PGH 127	PG 127	PG 47	PG 53	PG 89	PG 12	PG 172	PG 276	PG 180					PG 12M	PG 172M	PG 180M
uni capuccino						PG 453								PG 453M		
uni bege		PG 194		PG 54		PG 82								PG 82M		
uni ouro		PG 134				PG 74								PG 74M		
uni caramelo						PG 19								PG 19M		
uni salmão						PG 455								PG 455M		
uni cotto		PG 405				PG 454								PG 454M		
uni baunilha		PG 131	PG 48	PG 51	PG 90	PG 18	PG 162		PG 186					PG 18M	PG 162M	PG 186M
uni amêndoa						PG 17								PG 17M		
uni papaia						PG 499								PG 499M		
uni sol						PG 70RT			PG 432RT					PG 70M		PG 432M
uni tangerina						PG 69RT			PG 433RT					PG 69M		PG 433M
uni gema		PG 141				PG 101								PG 101M		
uni lima		PG 140				PG 100								PG 100M		
uni musgo		PG 414				PG 448								PG 448M		
uni limonete						PG 445								PG 445M		
uni trevo						PG 446								PG 446M		
uni menta		PG 135				PG 6								PG 6M		
uni turquesa		PG 136				PG 8								PG 8M		
uni tropical						PG 439RT			PG 435RT					PG 439M		PG 435M
uni mineral		PG 418		PG 363		PG 444								PG 444M		
uni céu		PG 198				PG 36								PG 36M		
uni lago		PG 137				PG 35								PG 35M		
uni água						PG 38								PG 38M		
uni lavanda						PG 354								PG 354M		
uni indigo						PG 438RT			PG 434RT					PG 438M		PG 434M

* Também disponível colado em rede. // Also available glued on mesh. // También disponible enmallado. // Disponible également collé sur trame. // auch auf Netz geklebt erhältlich

tipo de produto disponível type of product available tipo de producto disponible type de produit disponible Erhältliche Produkte																			
formatos . sizes . formatos formats . Formate (mm)	297x297	447x447	297x597	597x597	447x890	597x1190	890x890	297x297	297x597	597x597	97x97	147x147	147x147	197x197	197x197	197x197	297x297	297x297	
espessura . thickness . espesor . épaisseur . Stärke (mm)	7,6	8,5	8,5	9,8	9,8	9,8	9,8	8,3	9,2	10,5	8,3	8,3	12	8,3	12	12	8,3	14	
letras . letters . letras . lettres Buchstaben	P	P	P	P	P	P	P	E	EN	EN	-	X	Y	X	Y	YR	X	U	
	polido . polished . pulido . poli . poliert	polido . polished . pulido . poli . poliert	polido . polished . pulido . poli . poliert	polido . polished . pulido . poli . poliert	polido . polished . pulido . poli . poliert	polido . polished . pulido . poli . poliert	polido . polished . pulido . poli . poliert	estruturado . estructurado . structured structuré . Strukturiert V3 sem cristalina . without crystalline R11C V3 sem cristallino . sans cristalline . ohne Kristallin R11C	estruturado . estructurado . structured structuré . Strukturiert V3 sem cristalina . without crystalline R11C V3 sem cristallino . sans cristalline . ohne Kristallin R11C	estruturado . estructurado . structured structuré . Strukturiert V3 sem cristalina . without crystalline R11C V3 sem cristallino . sans cristalline . ohne Kristallin R11C	HEXAGON texturado . textured . texturé . texturiert R11B	DIN 5130 DIN 51097 antiderrapante . anti-slip . antidérapant . trittsicher R12C	DIN 5130 DIN 51097 antiderrapante . forte espessura . anti-slip extra thickness antidérapant . forte épaisseur . trittsicher Überstärke R12C	DIN 5130 DIN 51097 antiderrapante . anti-slip . antidérapant . trittsicher R12C	DIN 5130 DIN 51097 antiderrapante . forte espessura . anti-slip extra thickness antidérapant . forte épaisseur . trittsicher Überstärke R12C	DIN 5130 DIN 51097 antiderrapante . forte espessura . anti-slip extra thickness antidérapant . forte épaisseur . trittsicher Überstärke R12C	DIN 5130 DIN 51097 antiderrapante . anti-slip . antidérapant . trittsicher R13	DIN 5130 DIN 51097 antiderrapante . anti-slip . antidérapant . trittsicher R12C	DIN 5130 DIN 51097 antiderrapante . forte espessura . anti-slip extra thickness antidérapant . forte épaisseur . trittsicher Überstärke R12C

uni papoila	PG 68P			PG 431P															
uni pergamon	PG 67P	PG 164P						PG 67E											
uni cristal	PG 92P			PG 277P															
uni carvão	PG 23P	PG 165P	PG 269P	PG 175P	PG 469P			PG 23E				PG 43X	PG 43Y	PG 66X	PG 66Y			PG 23X	PG 23U
uni preto	PG 452P			PG 471P				PG 452E	PGS 520EN	PGS 471EN	PGHR 408								
uni metal	PG 24P		PG 268P	PG 263P	PG 470P	PG 502P	PG 507P				PGHR 189			PG 96X				PG 24X	
uni estanho	PG 25P	PG 158P	PG 207P	PG 183P				PG 25E	PGS 207EN	PGS 183EN	PGHR 122	PG 44X	PG 44Y	PG 52X	PG 52Y	PG 52YR	PG 25X	PG 25U	
uni zinco	PG 450P										PGHR 406								
uni prata	PG 26P	PG 171P	PG 280P	PG 430P				PG 26E	PGS 280EN	PGS 430EN							PG 26X		
uni névoa	PG 451P																		
uni caqui	PG 447P																		
uni gelo	PG 3P	PG 167P	PG 265P	PG 177P	PG 466P	PG 503P	PG 506P	PG 3E	PGS 265EN	PGS 177EN		PG 46X	PG 46Y	PG 2X	PG 2Y			PG 3X	PG 3U
uni pérola	PG 4P	PG 524P	PG 517P	PG 484P				PG 4E			PGHR 160	PG 505X	PG 505Y	PG 62X	PG 62Y			PG 4X	PG 4U
uni papiro	PG 5P													PG 58X		PG 58YR			
uni creme	PG 544P		PG 548P	PG 551P															
uni chocolate	PG 14P		PG 292P	PG 278P															
uni cacau	PG 78P																		
uni moka	PG 12P	PG 172P	PG 276P	PG 180P				PG 12E	PGS 276EN	PGS 180EN	PGHR 127	PG 47X	PG 47Y	PG 53X	PG 53Y			PG 12X	
uni capuccino	PG 453P																		
uni bege	PG 82P													PG 54X				PG 82X	
uni ouro	PG 74P																		
uni caramelo	PG 19P																		
uni salmão	PG 455P																		
uni cotto	PG 454P																		
uni baunilha	PG 18P	PG 162P		PG 186P				PG 18E				PG 48X	PG 48Y	PG 51X	PG 51Y				
uni amêndoa	PG 17P																		
uni papaia	PG 499P																		
uni sol	PG 70P			PG 432P															
uni tangerina	PG 69P			PG 433P															
uni gema	PG 101P																		
uni lima	PG 100P																		
uni musgo	PG 448P																		
uni limonete	PG 445P																		
uni trevo	PG 446P																		
uni menta	PG 6P																		
uni turquesa	PG 8P																		
uni tropical	PG 439P			PG 435P															
uni mineral	PG 444P													PG 363X					
uni céu	PG 36P																		
uni lago	PG 35P																		
uni água	PG 38P																		
uni lavanda	PG 354P																		
uni indigo	PG 438P			PG 434P															

tipo de produto disponível type of product available tipo de producto disponible type de produit disponible Erhältliche Produkte	mate . mat . matt R10				acabamento mate espessura intermédia matt medium thickness acabado mate espesor intermedio finition mat épaisseur moyenne Matt Mittlere Stärke U4 P4+ R9 A		acabamento mate forte espessura matt extra thickness acabado mate fuerte espesor finition mate forte épaisseur Matt Überstärke U4 P4S R9 A		acabamento mate forte espessura matt extra thickness acabado mate fuerte espesor finition mate forte épaisseur Matt Überstärke U4 P4S R9 A		TACTILE mate . mat . matt R10B		TACTILE mate . mat . matt R10B		rodapé prensado direito (mate) pressed skirting board (matt) rodapié prensado recto (mate) plinthe à bord biseauté (mat) Sockelleiste (matt)		rodapé prensado curvo (mate) pressed cove base sit-on (matt) rodapié prensado curvo (mate) plinthe à recouvrement (mat) Hohlkehlsockel (matt)		rodapé prensado curvo (mate) pressed cove base sit-in (matt) rodapié prensado curvo (mate) plinthe à gorge (mat) Hohlkehlsockel (matt)		rodapé prensado curvo (mate) pressed cove base sit-in (matt) rodapié prensado curvo (mate) plinthe à gorge (mat) Hohlkehlsockel (matt)	
	formatos . sizes . formatos formats . Formate (mm)	97x97	297x297	97x597	597x597	297x297	447x447	147x147	197x197	297x297	597x597	297x297	297x297	97x297	97x297	97x197	97x297					
	espessura . thickness . espesor . épaisseur . Stärke (mm)	8,3	8,3	9,2	10,5	11	11	12	12	14	14	14	14	8,3	8,3	8,3	8,3					
	letras . letters . letras . lettres . Buchstaben					K	K	Z	Z	V	V	V	V	B	F	G	G					

uni papoila																		
uni pergamon					PG 67K	PG 164K							PG 67B	PG 67F	PG 60G			
uni cristal																		
uni carvão					PG 23K	PG 165K	PG 43Z	PG 66Z	PG 23V				PG 23B	PG 23F	PG 66G			
uni preto	PGK 408	PGK 452	PGK 549	PGK 471								PGSTP 452V	PGSTB 452V			PG 369G	PG 452G	
uni metal	PGK 189	PGK 24	PGK 268	PGK 263												PG 96G	PG 24G	
uni estanho	PGK 122	PGK 25	PGK 207	PGK 183	PG 25K	PG 158K	PG 44Z	PG 52Z	PG 25V	PG183V	PGSTP 25V	PGSTB 25V	PG 25B	PG 25F	PG 52G	PG 25G		
uni zinco	PGK 406	PGK 450	PGK 546	PGK 550													PG 450G	
uni prata	PGK 124	PGK 26	PGK 280	PGK 430	PG 26K	PG 171K							PG 26B	PG 26F	PG 50G			
uni névoa																		
uni caqui																		
uni gelo	PGK 1	PGK 3	PGK 265	PGK 177	PG 3K	PG 167K	PG 46Z	PG 2Z	PG 3V	PG 177V			PG 3B	PG 3F	PG 2G			
uni pérola	PGK 160	PGK 4	PGK 517	PGK 484	PG 4K	PG 524K	PG 505Z	PG 62Z	PG 4V	PG484V	PGSTP 4V	PGSTB 4V	PG 4B	PG 4F	PG 62G			
uni papiro	PGK 191	PGK 5	PGK 547	PGK 552											PG 58G	PG 5G		
uni creme	PGK 545	PGK 544	PGK 548	PGK 551														
uni chocolate																PG 95G		
uni cacau																		PG 78G
uni moka	PGK 127	PGK 12	PGK 276	PGK 180	PG 12K	PG 172K	PG 47Z	PG 53Z	PG 12V				PG 12B	PG 12F	PG 53G	PG 12G		
uni capuccino																		
uni bege																PG 54G	PG 82G	
uni ouro																		
uni caramelo																		
uni salmão																		
uni cotto																		
uni baunilha					PG 18K	PG 162K	PG 48Z	PG 51Z	PG 18V				PG 18B	PG 18F	PG 51G			
uni amêndoa																		
uni papaia																		
uni sol																		
uni tangerina																		
uni gema																		
uni lima																		
uni musgo																		
uni limonete																		
uni trevo																		
uni menta																		
uni turquesa																		
uni tropical																		
uni mineral																	PG 363G	
uni céu																		
uni lago																		
uni água																		
uni lavanda																		
uni indigo																		

rodapé cortado (mate) cut skirting board rounded edge (mat) rodapé cortado (mate) plinthe avec bord arrondi (mat coupé) Sockelleiste mit abgerundeter Kante geschnitten (mat)			rodapé cortado (macio) cut skirting board rounded edge (honed) rodapé cortado (macio) plinthe avec bord arrondi (adoucie coupé) Sockelleiste mit abgerundeter Kante geschnitten (weich)			rodapé cortado (polido) cut skirting board rounded edge (polished) rodapé cortado (polido) plinthe avec bord arrondi (poli coupé) Sockelleiste mit abgerundeter Kante geschnitten (poliert)			ángulo interno para rodapé curvo 97x297 internal angle for cove base 97x297 ángulo interno para rodapé curvo 97x297 angle intérieur pour plinthe à talon 97x297 Innenecken für Hohlschüssel 97x297 ángulo externo para rodapé curvo 97x297 external angle for cove base 97x297 ángulo externo para rodapé curvo 97x297 angle extérieur pour plinthe à talon 97x297 Aussenecken für Hohlschüssel 97x297 ángulo interno para rodapé curvo 97x197 e 97x297 internal angle for cove base 97x197 and 97x297 ángulo interno para rodapé curvo 97x197 y 97x297 angle intérieur pour plinthe à gorge 97x197 et 97x297 Innenecken für Hohlschüssel 97x197 und 97x297 ángulo externo para rodapé curvo 97x197 e 97x297 external angle for cove base 97x197 and 97x297 ángulo externo para rodapé curvo 97x197 y 97x297 angle extérieur pour plinthe à gorge 97x197 et 97x297 Aussenecken für Hohlschüssel 97x197 und 97x297				degrau (mate) . step tread (mat) pedaño (mate) . nez de marche (mat) Stufenplatte (mat) R6			degrau (macio) . step tread (honed) pedaño (macio) . nez de marche (adoucie) Stufenplatte (weich)			degrau (polido) . step tread (polished) pedaño (polido) . nez de marche (poli) Stufenplatte (poliert)		
95x297	95x447	95x597	95x297	95x447	95x597	95x297	95x447	95x597	25x97	25x97	25x97	25x97	297x297	297x297	297x297						
8,3	9,2		8,3	9,2		7,6	8,5		8,3	8,3	8,3	8,3	8,3	8,3	7,6						
H	L	W	HM	LM	WM	HP	LP	WP	FI	FE	GI	GE	D	DM	DP						
PG 68HRT		PG 431WRT	PG 68HM			PG 68HP		PG 431WP					PG 68D	PG 68DM	PG 68DP						
PG 67H	PG 164L		PG 67HM	PG 164LM		PG 67HP	PG 164LP		PG 67FI	PG 67FE	PG 60GI	PG 60GE	PG 67D	PG 67DM	PG 67DP						
PG 92HRT		PG 277WRT	PG 92HM			PG 92HP		PG 277WP					PG 92D	PG 92DM	PG 92DP						
PG 23H	PG 165L	PG 175W	PG 23HM	PG 165LM	PG 175WM	PG 23HP	PG 165LP	PG 175WP	PG 23FI	PG 23FE	PG 66GI	PG 66GE	PG 23D	PG 23DM	PG 23DP						
PG 452H		PG 471W	PG 452HM			PG 452HP		PG 471WP			PG 369GI	PG 369GE	PG 452D	PG 452DM	PG 452DP						
PG 24H		PG 263W	PG 24HM		PG 263WM	PG 24HP		PG 263WP			PG 96GI	PG 96GE	PG 24D	PG 24DM	PG 24DP						
PG 25H	PG 158L	PG 183W	PG 25HM	PG 158LM	PG 183WM	PG 25HP	PG 158LP	PG 183WP	PG 25FI	PG 25FE	PG 52GI	PG 52GE	PG 25D	PG 25DM	PG 25DP						
PG 450H			PG 450HM			PG 450HP					PG 367GI	PG 367GE	PG 450D	PG 450DM	PG 450DP						
PG 26H	PG 171L	PG 430W	PG 26HM	PG 171LM		PG 26HP	PG 171LP	PG 430WP	PG 26FI	PG 26FE	PG 50GI	PG 50GE	PG 26D	PG 26DM	PG 26DP						
PG 451H			PG 451HM			PG 451HP							PG 451D	PG 451DM	PG 451DP						
PG 447H			PG 447HM			PG 447HP							PG 447D	PG 447DM	PG 447DP						
PG 3H	PG 167L	PG 177W	PG 3HM	PG 167LM	PG 177WM	PG 3HP	PG 167LP	PG 177WP	PG 3FI	PG 3FE	PG 2GI	PG 2GE	PG 3D	PG 3DM	PG 3DP						
PG 4H	PG 524L	PG 484W	PG 4HM	PG 524LM	PG 484WM	PG 4HP	PG 524LP	PG 484WP	PG 4FI	PG 4FE	PG 62GI	PG 62GE	PG 4D	PG 4DM	PG 4DP						
PG 5H			PG 5HM			PG 5HP					PG 58GI	PG 58GE	PG 5D	PG 5DM	PG 5DP						
PG 544H			PG 544HM			PG 544HP							PG 544D	PG 544DM	PG 544DP						
PG 14H		PG 278W	PG 14HM		PG 278WM	PG 14HP		PG 278WP			PG 95GI	PG 95GE	PG 14D	PG 14DM	PG 14DP						
PG 78H			PG 78HM			PG 78HP					PG 97GI	PG 97GE	PG 78D	PG 78DM	PG 78DP						
PG 12H	PG 172L	PG 180W	PG 12HM	PG 172LM	PG 180WM	PG 12HP	PG 172LP	PG 180WP	PG 12FI	PG 12FE	PG 53GI	PG 53GE	PG 12D	PG 12DM	PG 12DP						
PG 453H			PG 453HM			PG 453HP							PG 453D	PG 453DM	PG 453DP						
PG 82H			PG 82HM			PG 82HP					PG 54GI	PG 54GE	PG 82D	PG 82DM	PG 82DP						
PG 74H			PG 74HM			PG 74HP							PG 74D	PG 74DM	PG 74DP						
PG 19H			PG 19HM			PG 19HP							PG 19D	PG 19DM	PG 19DP						
PG 455H			PG 455HM			PG 455HP							PG 455D	PG 455DM	PG 455DP						
PG 454H			PG 454HM			PG 454HP							PG 454D	PG 454DM	PG 454DP						
PG 18H	PG 162L	PG 186W	PG 18HM	PG 162LM	PG 186WM	PG 18HP	PG 162LP	PG 186WP	PG 18FI	PG 18FE	PG 51GI	PG 51GE	PG 18D	PG 18DM	PG 18DP						
PG 17H			PG 17HM			PG 17HP							PG 17D	PG 17DM	PG 17DP						
PG 499H			PG 499HM			PG 499HP							PG 499D	PG 499DM	PG 499DP						
PG 70HRT		PG 432WRT	PG 70HM			PG 70HP		PG 432WP					PG 70D	PG 70DM	PG 70DP						
PG 69HRT		PG 433WRT	PG 69HM			PG 69HP		PG 433WP					PG 69D	PG 69DM	PG 69DP						
PG 101H			PG 101HM			PG 101HP							PG 101D	PG 101DM	PG 101DP						
PG 100H			PG 100HM			PG 100HP							PG 100D	PG 100DM	PG 100DP						
PG 448H			PG 448HM			PG 448HP							PG 448D	PG 448DM	PG 448DP						
PG 445H			PG 445HM			PG 445HP							PG 445D	PG 445DM	PG 445DP						
PG 446H			PG 446HM			PG 446HP							PG 446D	PG 446DM	PG 446DP						
PG 6H			PG 6HM			PG 6HP							PG 6D	PG 6DM	PG 6DP						
PG 8H			PG 8HM			PG 8HP							PG 8D	PG 8DM	PG 8DP						
PG 439HRT		PG 435WRT	PG 439HM			PG 439HP		PG 435WP					PG 439D	PG 439DM	PG 439DP						
PG 444H			PG 444HM			PG 444HP					PG 363GI	PG 363GE	PG 444D	PG 444DM	PG 444DP						
PG 36H			PG 36HM			PG 36HP							PG 36D	PG 36DM	PG 36DP						
PG 35H			PG 35HM			PG 35HP							PG 35D	PG 35DM	PG 35DP						
PG 38H			PG 38HM			PG 38HP							PG 38D	PG 38DM	PG 38DP						
PG 354H			PG 354HM			PG 354HP							PG 354D	PG 354DM	PG 354DP						
PG 438HRT		PG 434WRT	PG 438HM			PG 438HP		PG 434WP					PG 438D	PG 438DM	PG 438DP						

tipo de produto disponível type of product available tipo de producto disponible type de produit disponible Erhältliche Produkte	polido . polished . pulido . poli . poliert		polido . polished . pulido . poli . poliert		polido . polished . pulido . poli . poliert		estruturado . estruturado . structured structure . Strukturieret V2 sem cristalina . without crystalline sin cristalino . sans cristalline . ohne Kristallin R11B		estruturado . estruturado . structured structure . Strukturieret versão 1 . version 1 . Version 1 R11C		DIN 51130 DIN 51097 antiderapante . anti-slip . antidérapant . trittsicher R12C		DIN 51130 DIN 51097 antiderapante forte espessura . anti-slip extra thickness antiderapante fuerte espesor antidérapant forte épaisseur . trittsicher Überstärke R12C		DIN 51130 DIN 51097 antiderapante forte espessura . anti-slip extra thickness antiderapante fuerte espesor antidérapant forte épaisseur . trittsicher Überstärke R13		DIN 51130 DIN 51097 antiderapante . anti-slip . antidérapant . trittsicher R12C		DIN 51130 DIN 51097 antiderapante forte espessura . anti-slip extra thickness antiderapante fuerte espesor antidérapant forte épaisseur . trittsicher Überstärke R12C	
formatos . sizes . formats formats . Formate (mm)	297x297		447x447		597x597		147x147		297x297		197x197		197x197		197x197		297x297		297x297	
espessura . thickness . espesor . épaisseur . Stärke (mm)	7,6		8,5		9,8		8,3		8,3		8,3		12		12		8,3		14	
letras . letters . letras . lettres . Buchstaben	P		P		P		EB		E		X		Y		YR		X		U	









fino carvão	PG 244P	PG 245P	PG 246P		PG 244E	PG 243X	PG 243Y		PG 244X	PG 244U
fino preto	PG 353P			PG 511EB	PG 353E					
fino metal	PG 27P					PG 219X			PG 27X	
fino estanho	PG 28P	PG 159P	PG 184P	PG 205EB	PG 28E	PG 104X	PG 104Y	PG 104YR	PG 28X	PG 28U
fino zinco	PG 461P			PG 510EB						
fino prata	PG 29P								PG 29X	
fino névoa	PG 462P									
fino gelo	PG 33P	PG 169P	PG 178P	PG 203EB	PG 33E	PG 105X	PG 105Y		PG 33X	PG 33U
fino pérola	PG 355P	PG 526P	PG 527P		PG 355E	PG 525X	PG 525Y		PG 355X	PG 355U
fino papiro	PG 335P					PG 483X		PG 483YR		
fino cacau	PG 334P									
fino moka	PG 15P	PG 173P		PG 202EB	PG 15E	PG 102X	PG 102Y		PG 15X	
fino capuccino	PG 463P									
fino bege	PG 83P					PG 254X			PG 83X	
fino salmão	PG 464P									
fino baunilha	PG 21P	PG 163P			PG 21E	PG 103X	PG 103Y			
fino amêndoa	PG 20P									
fino trevo	PG 460P									
fino turquesa	PG 10P									
fino mineral	PG 459P					PG 389X				
fino céu	PG 39P									
fino água	PG 41P									

tipo de produto disponível type of product available tipo de producto disponible Erhältliche Produkte	acabamento mate espessura intermédia matt medium thickness acabado mate espesor intermedio finition mat épaisseur moyenne Matt Mittlere Stärke U4 P4+ R9A		acabamento mate espessura intermédia matt medium thickness acabado mate espesor intermedio finition mat épaisseur moyenne Matt Mittlere Stärke U4 P4+ R9A		acabamento mate forte espessura matt extra thickness acabado mate fuerte espesor finition mate forte épaisseur Matt Überstärke U4 P4S R9A		acabamento mate forte espessura matt extra thickness acabado mate fuerte espesor finition mate forte épaisseur Matt Überstärke U4 P4S R9A		rodapé prensado direito (mate) pressed skirting board (matt) rodapié prensado recto (mate) plinthe à bord biseauté (mat) Sockelleiste (matt)	rodapé prensado curvo (mate) pressed cove base sit-on (matt) rodapié prensado curvo (mate) plinthe à recouvrement (mat) Hohlkehlsockel (matt)	rodapé prensado curvo (mate) pressed cove base sit-in (matt) rodapié prensado curvo (mate) plinthe à gorge (mat) Hohlkehlsockel (matt)	rodapé prensado curvo (mate) pressed cove base sit-in (matt) rodapié prensado curvo (mate) plinthe à gorge (mat) Hohlkehlsockel (matt)	rodapé cortado (mate) cut skirting board rounded edge (matt) rodapié cortado (mate) plinthe avec bord arrondi (mat coupé) Sockelleiste mit abgerundeter Kante geschnitten (matt)	rodapé cortado (mate) cut skirting board rounded edge (matt) rodapié cortado (mate) plinthe avec bord arrondi (mat coupé) Sockelleiste mit abgerundeter Kante geschnitten (matt)	rodapé cortado (mate) cut skirting board rounded edge (matt) rodapié cortado (mate) plinthe avec bord arrondi (mat coupé) Sockelleiste mit abgerundeter Kante geschnitten (matt)
formatos . sizes . formatos formats . Formate (mm)	297x297	447x447	197x197	297x297	97x297	97x297	97x197	97x297	95x297	95x447	95x597				
espessura . thickness . espesor . épaisseur . Stärke (mm)	11	11	12	14	8,3	8,3	8,3	8,3	8,3	9,2	10,5				
letras . letters . letras . lettres . Buchstaben	K	K	Z	V	B	F	G	G	H	L	W				
fino carvão	PG 244K	PG 245K	PG 243Z	PG 244V	PG 244B	PG 244F	PG 243G		PG 244H	PG 245L	PG 246W				
fino preto							PG 474G	PG 353G	PG 353H						
fino metal							PG 219G	PG 27G	PG 27H						
fino estanho	PG 28K	PG 159K	PG 104Z	PG 28V	PG 28B	PG 28F	PG 104G	PG 28G	PG 28H	PG 159L	PG 184W				
fino zinco								PG 461G	PG 461H						
fino prata									PG 29H						
fino névoa									PG 462H						
fino gelo	PG 33K	PG 169K	PG 105Z	PG 33V	PG 33B	PG 33F	PG 105G		PG 33H	PG 169L	PG 178W				
fino pérola	PG 355K	PG 526K	PG 525Z	PG 355V	PG 355B	PG 355F	PG 525G		PG 355H	PG 526L	PG 527W				
fino papiro							PG 483G	PG 335G	PG 335H						
fino cacau								PG 334G	PG 334H						
fino moka	PG 15K	PG 173K	PG 102Z	PG 15V	PG 15B	PG 15F	PG 102G	PG 15G	PG 15H	PG 173L					
fino capuccino									PG 463H						
fino bege							PG 254G	PG 83G	PG 83H						
fino salmão									PG 464H						
fino baunilha	PG 21K	PG 163K	PG 103Z	PG 21V	PG 21B	PG 21F	PG 103G		PG 21H	PG 163L					
fino amêndoa									PG 20H						
fino trevo									PG 460H						
fino turquesa									PG 10H						
fino mineral							PG 389G		PG 459H						
fino céu									PG 39H						
fino água									PG 41H						

tipo de produto disponível type of product available tipo de producto disponible type de produit disponible Erhältliche Produkte	rodapé cortado (polido) cut skirting board rounded edge (polished) rodapé cortado (pulido) plinthe avec bord arrondi (poli coupé) Sockelleiste mit abgerundeter Kante geschliffen (poliert)	rodapé cortado (polido) cut skirting board rounded edge (polished) rodapé cortado (pulido) plinthe avec bord arrondi (poli coupé) Sockelleiste mit abgerundeter Kante geschliffen (poliert)	rodapé cortado (polido) cut skirting board rounded edge (polished) rodapé cortado (pulido) plinthe avec bord arrondi (poli coupé) Sockelleiste mit abgerundeter Kante geschliffen (poliert)	ângulo interno para rodapé curvo 97x297 internal angle for cove base 97x297 ángulo interno para rodapé curvo 97x297 angle intérieur pour plinthe à talon 97x297 Innenecken für Hohlkehlsöckel 97x297	ângulo externo para rodapé curvo 97x297 external angle for cove base 97x297 ángulo externo para rodapé curvo 97x297 angle extérieur pour plinthe à talon 97x297 Aussenecken für Hohlkehlsöckel 97x297	ângulo interno para rodapé curvo 97x197 e 97x297 internal angle for cove base 97x197 and 97x297 ángulo interno para rodapé curvo 97x197 y 97x297 angle intérieur pour plinthe à gorge 97x197 et 97x297 Innenecken für Hohlkehlsöckel 97x197 und 97x297	ângulo externo para rodapé curvo 97x197 e 97x297 external angle for cove base 97x197 and 97x297 ángulo externo para rodapé curvo 97x197 y 97x297 angle extérieur pour plinthe à gorge 97x197 et 97x297 Aussenecken für Hohlkehlsöckel 97x197 und 97x297	degrau (mate) . step tread (matt) peldaño (mate) . nez de marche (matt) Stufenplatte (matt) R9A	degrau (polido) . step tread (polished) peldaño (pulido) . nez de marche (poli) Stufenplatte (poliert)	
	formatos . sizes . formatos formats . Formate (mm)	95x297	95x447	95x597	25x97	25x97	25x97	25x97	297x297	297x297
	espessura . thickness . espesor . épaisseur . Stärke (mm)	7,6	8,5	9,8	8,3	8,3	8,3	8,3	8,3	7,6
	letras . letters . letras . lettres . Buchstaben	HP	LP	WP	FI	FE	GI	GE	D	DP

fino carvão	PG 244HP	PG 245LP	PG 246WP	PG 244FI	PG 244FE	PG 243GI	PG 243GE	PG 244D	PG 244DP
fino preto	PG 353HP					PG 474GI	PG 474GE	PG 353D	PG 353DP
fino metal	PG 27HP					PG 219GI	PG 219GE	PG 27D	PG 27DP
fino estanho	PG 28HP	PG 159LP	PG 184WP	PG 28FI	PG 28FE	PG 104GI	PG 104GE	PG 28D	PG 28DP
fino zinco	PG 461HP					PG 402GI	PG 402GE	PG 461D	PG 461DP
fino prata	PG 29HP							PG 29D	PG 29DP
fino névoa	PG 462HP							PG 462D	PG 462DP
fino gelo	PG 33HP	PG 169LP	PG 178WP	PG 33FI	PG 33FE	PG 105GI	PG 105GE	PG 33D	PG 33DP
fino pérola	PG 355HP	PG 526LP	PG 527WP	PG 355FI	PG 355FE	PG 525GI	PG 525GE	PG 355D	PG 355DP
fino papiro	PG 335HP					PG 483GI	PG 483GE	PG 335D	PG 335DP
fino cacau	PG 334HP					PG 508GI	PG 508GE	PG 334D	PG 334DP
fino moka	PG 15HP	PG 173LP		PG 15FI	PG 15FE	PG 102GI	PG 102GE	PG 15D	PG 15DP
fino capuccino	PG 463HP							PG 463D	PG 463DP
fino bege	PG 83HP					PG 254GI	PG 254GE	PG 83D	PG 83DP
fino salmão	PG 464HP							PG 464D	PG 464DP
fino baunilha	PG 21HP	PG 163LP		PG 21FI	PG 21FE	PG 103GI	PG 103GE	PG 21D	PG 21DP
fino amêndoa	PG 20HP							PG 20D	PG 20DP
fino trevo	PG 460HP							PG 460D	PG 460DP
fino turquesa	PG 10HP							PG 10D	PG 10DP
fino mineral	PG 459HP					PG 389GI	PG 389GE	PG 459D	PG 459DP
fino céu	PG 39HP							PG 39D	PG 39DP
fino água	PG 41HP							PG 41D	PG 41DP













EN1441; Anexo . Annexe L; grupo | group | groupe BIII

	VALOR / TOLERÂNCIAS DA NORMA Standard Required by the Norm Valor / Tolerâncias de la Norma Valeur Prescrite de la Norm von den Normen vorgeschriebener Wert	VALOR MÉDIO CEREV Mean Value Valor medio Valeur Moyenne Mittelwert	NORMA DE ENSAIO Test Norm Norma de ensayo Norme d'Essai Norm der Probe	
 CARACTERÍSTICAS DIMENSIONAIS dimensional characteristics características dimensionales caractéristiques mesurables dimensionale Eigenschaften	DIMENSÕES LINEARES linear dimensions • dimensiones lineales dimension linéaires • Länge und Breite	$\Delta \pm 0,5\%$ Max. $\pm 2\text{mm}$		
	ORTOGONALIDADE orthogonilty • ortogonalidad orthogonalité • Orthogonalität	$\Delta \pm 0,5\%$ Max. $\pm 2\text{mm}$		
	RECTILINEARIDADE straightness of edges • rectilinealidad rectitude des chants • Geradlinigkeit	$\Delta \pm 0,3\%$ Max. $\pm 1,5\text{mm}$	GARANTIDO guaranteed garantizado garantie garantiert	NP EN ISO 10545-2
	PLANARIDADE flatness • planadad planeité • Ebenfächigkeit	$\Delta +0,5\% / -0,3\%$ Max. $+ 2 / -1,5\text{mm}$		
	ESPESSURA thickness • espesor épaisseur • Stärke	$\Delta \pm 10\%$ Max. $\pm 0,5\text{mm}$		
 ABSORÇÃO DE ÁGUA % water absorption in % absorción de agua en % absorption d'eau en % Wasseraufnahme in gew %	>10%	16-19%	NP EN ISO 10545-3	
 RESISTÊNCIA MECÂNICA À FLEXÃO EM N • MÓDULO DE RUPTURA N / mm² breaking strength in N • rupture modulus N / mm ² resistencia mecánica a la flexión en N • modulo de ruptura N / mm ² résistance à la flexion en N • module de rupture N / mm ² Biegefestigkeit in N • Bruchmodul N / mm ²	(<7,5mm) $\geq 200\text{N}$ $\geq 15\text{N/mm}^2$ ($\geq 7,5\text{mm}$) $\geq 600\text{N}$ $\geq 12\text{N/mm}^2$	(<7,5mm) $> 300\text{N}$ $\geq 16\text{N/mm}^2$ ($\geq 7,5\text{mm}$) $> 600\text{N}$ $\geq 16\text{N/mm}^2$	NP EN ISO 10545-4	
 DILATAÇÃO TÉRMICA LINEAR ($\times 10^{-6}\text{K}^{-1}$) linear thermal dilatation ($\times 10^{-6}\text{K}^{-1}$) dilatación térmica lineal ($\times 10^{-6}\text{K}^{-1}$) dilatation thermique linéaire ($\times 10^{-6}\text{K}^{-1}$) Wärmeausdehnungskoeffizient ($\times 10^{-6}\text{K}^{-1}$)	DECLARAR VALOR Declare value Déclarer la valeur Wert angeben	<9	NP EN ISO 10545-8	
 RESISTÊNCIA AO CHOQUE TÉRMICO resistance to thermal shock resistencia al choque térmico résistance aux écarts thermiques Widerstand bei Temperaturwechsel		ENSAIO POR SOLICITAÇÃO test upon request ensayo por solicitacion essai sur demande Probe bei Anfrage	NP EN ISO 10545-9	
 RESISTÊNCIA À FENDILHAGEM resistance to hair cracking resistencia al cuarteado résistance tresailage Beständigkeit gegen Haarrisse	EXIGIDO required exigido exigence verlangt	GARANTIDO guaranteed garantizado garantie garantiert	NP EN ISO 10545-11	
 RESISTÊNCIA A PRODUTOS DOMÉSTICOS DE LIMPEZA E ADITIVOS PARA PISCINAS resistance to household products and swimming-pool additives resistencia a los productos domésticos de limpieza y aditivos para piscinas résistance aux produits d'entretien menagers et produits chimiques pour piscine Beständigkeit gegen Haushaltsreiniger und Schwimmbadzusätze	min. classe B minimum class B	GARANTIDO guaranteed garantizado garantie garantiert	NP EN ISO 10545-13	
 RESISTÊNCIA AOS ÁCIDOS E BASES DE BAIXAS/ ALTAS CONCENTRAÇÕES resistance to low/ high concentrations of acids and alkalis resistencia a los ácidos y bases de bajas/ altas concentraciones résistance aux acides et bases de faible/ haute concentration Säurewiderstand auf Grundlage der niedrigeren/ höheren Konzentration	REPORTAR CLASSIFICAÇÃO P/ BAIXAS CONCENTRAÇÕES / FACULTATIVO P/ AS ALTAS CONCENTRAÇÕES. To inform classification for low concentration of acid and alkalis resistance / facultative for high concentrations of acid and alkalis resistance. Reportar clasificación p/ bajas concentraciones / facultativo p/ as altas concentraciones. À indiquer la classification à résistance aux acide et bases de faible concentration / facultatif pour la résistance aux acide et bases de haute concentration. Klassifikation für niedrige Konzentrationen angeben / fakultativ für hohe Konzentrationen.	A CONFIRMAR CASO A CASO to be confirmed a confirmar caso a caso à confirmer bestätigen	NP EN ISO 10545-13	
 RESISTÊNCIA ÀS MANCHAS resistance to staining resistencia a las manchas résistance aux taches Fleckbeständigkeit	min. classe 3 minimum class 3	GARANTIDO guaranteed garantizado garantie garantiert	NP EN ISO 10545-14	
 LIBERTAÇÃO DE CHUMBO E CÁDMIO cadmium and lead release liberación de plomo y cadmio libération de cadmium et plomb Befreiung von Blei und Kadmium	PARA SUPERFÍCIES ESPECIAIS (EX. BANCADA DE COZINHA) Pour surfaces especiales (ex. plan de travail de cuisine) Para superficies especiales (ex. banca de cocinã) For special surfaces (ex. kitchen counters) Für spezielle Oberflächen (Beispiel: Küchenarbeitsplatten)	ENSAIO POR SOLICITAÇÃO test upon request ensayo por solicitacion essai sur demande Probe bei Anfrage	NP EN ISO 10545-15	



NÃO SE ACEITAM RECLAMAÇÕES DEPOIS DO MOSAICO CERÂMICO APLICADO. | No claims accepted after ceramic tiles are fixed. | No se aceptan reclamaciones después de estar aplicado el material.
 Aucune reclamation ne sera acceptée après la pose du carrelage. | Nach dem Verlegen der Fliesen werden keine Reklamationen angenommen.

EN14411; Anexo . Annexe H; grupo | group | groupe B₁

	VALOR / TOLERÂNCIAS DA NORMA Standard Required by the Norm Valor / Tolerâncias de la Norma Valeur Prescrite de la Norme von den Normen vorgeschriebener Wert	VALOR MÉDIO PAVIGRÉS Mean Value Valor medio Valeur Moyenne Mittelwert	NORMA DE ENSAIO Test Norm Norma de ensayo Norme d'Essai Norm der Probe		
	DIMENSÕES LINEARES linear dimensions • dimensiones lineales dimension linéaires • Länge und Breite	$\Delta \pm 0,6\%$ Max. $\pm 2\text{mm}$	$\pm 0,2\%$ excepto 10x10cm: $\pm 0,3\%$ except/ excepto/ sauf/ außer		
	ORTOGONALIDADE orthogonilty • ortogonalidad orthogonalité • Orthogonalität	$\Delta \pm 0,5\%$ Max. $\pm 2\text{mm}$	$\pm 0,3\%$		
	RECTILINEARIDADE straightness of edges • rectilinealidad rectitude des chants • Geradlinigkeit	$\Delta \pm 0,5\%$ Max. $\pm 1,5\text{mm}$	$\pm 0,2\%$	NP EN ISO 10545-2	
	PLANARIDADE flatness • planadad planeité • Ebenflächigkeit	$\Delta \pm 0,5\%$ Max. $\pm 2\text{mm}$	$\pm 0,2\%$		
	ESPESSURA thickness • espesor épaisseur • Stärke	$\Delta \pm 5\%$ Max. $\pm 0,5\text{mm}$	$\pm 3\%$		
	ABSORÇÃO DE ÁGUA % water absorption in % absorción de agua en % absorption d'eau en % Wasseraufnahme in gew %	$0,5\% < E_w \leq 3\%$ Max. indiv. 3,3%	$-1 - 2,5\%$ NP EN ISO 10545-3 (Método Vácuo) (Vacuum Method)		
	RESISTÊNCIA MECÂNICA À FLEXÃO EM N • MÓDULO DE RUPTURA N / mm ² breaking strength in N • rupture modulus N / mm ² resistencia mecánica a la flexión en N • modulo de ruptura N / mm ² résistance à la flexion en N • module de rupture N / mm ² Biegefestigkeit in N • Bruchmodul N / mm ²	$<7,5\text{mm} \geq 700\text{N}$ $\geq 7,5\text{mm} \geq 1100\text{N}$	$\geq 30\text{N/mm}^2$ Min. indiv. 27N/mm ²	$(6\text{mm}) \geq 720\text{N}$ $(7\text{mm}) \geq 1050\text{N}$ $(8,3\text{mm}) \geq 1500\text{N}$	$\geq 40\text{N/mm}^2$ NP EN ISO 10545-4
	RESISTÊNCIA AO DESGASTE surface resistance resistencia al desgaste résistance à l'abrasion gegen Verschleiss	REPORTAR CLASSE DE ABRASÃO PEI To inform PEI scratch resistance rate Reportar clase de abrasión PEI À indiquer la classification de l'abrasion PEI Abriebruppe angeben PEI	INDICADO PARA CADA REF ^a indicated for each ref. indicado para cada ref ^a indiqué pour chaque ref. passt zu jede Referenz	NP EN ISO 10545-7	
	RESISTÊNCIA AO CHOQUE TÉRMICO resistance to thermal shock resistencia al choque térmico résistance aux écarts thermiques Widerstand bei Temperaturwechsel		RESISTENTE resistant resistente resistant Widerstandsfähig	NP EN ISO 10545-9	
	RESISTÊNCIA À FENDILHAGEM resistance to hair cracking resistencia al cuarteado résistance tresaillage Beständigkeit gegen Haarrisse	EXIGIDO required exigido exigence verlangt	GARANTIDO guaranteed garantizado garantie garantiert	NP EN ISO 10545-11	
	RESISTÊNCIA AO GELO frost resistance resistencia al hielo résistance au gel Frostbeständigkeit	EXIGIDO required exigido exigence verlangt	RESISTENTE resistant resistente resistant Widerstandsfähig	NP EN ISO 10545-12	
	RESISTÊNCIA A PRODUTOS DOMÉSTICOS DE LIMPEZA E ADITIVOS PARA PISCINAS resistance to household products and swimming-pool additives resistencia a los productos domésticos de limpieza y aditivos para piscinas résistance aux produits d'entretien menagers et produits chimiques pour piscine Beständigkeit gegen Haushaltsreiniger und Schwimmbadzusätze	min. classe B minimum class B	GARANTIDO guaranteed garantizado garantie garantiert	NP EN ISO 10545-13	
	RESISTÊNCIA AOS ÁCIDOS E BASES DE BAIXAS/ ALTAS CONCENTRAÇÕES resistance to low/ high concentrations of acids and alkalis resistencia a los ácidos y bases de bajas/ altas concentraciones résistance aux acides et bases de faible/ haute concentration Säurewiderstand auf Grundlage der niedrigeren/ höheren Konzentration	REPORTAR CLASSIFICAÇÃO P/ BAIXAS CONCENTRAÇÕES / FACULTATIVO P/ AS ALTAS CONCENTRAÇÕES. To inform classification for low concentration of acid and alkalis resistance / facultative for high concentrations of acid and alkalis resistance. Reportar clasificación p/ bajas concentraciones / facultativo p/ as altas concentraciones. À indiquer la classification à résistance aux acide et bases de faible concentration / facultatif pour la résistance aux acide et bases de haute concentration. Klassifikation für niedrige Konzentrationen angeben / fakultativ für hohe Konzentrationen.	A CONFIRMAR CASO A CASO to be confirmed a confirmar caso a caso à confirmer bestätigen	NP EN ISO 10545-13	
	RESISTÊNCIA ÀS MANCHAS resistance to staining resistencia a las manchas résistance aux taches Fleckbeständigkeit	min. classe 3	GARANTIDO guaranteed garantizado garantie garantiert	NP EN ISO 10545-14	
	LIBERTAÇÃO DE CHUMBO E CÁDMIO cadmium and lead release liberación de plomo y cadmio libération de cadmium et plomb Befreiung von Blei und Kadmium	PARA SUPERFÍCIES ESPECIAIS (EX. BANCADA DE COZINHA) For special surfaces (ex. kitchen counters) Para superficies especiales (ex. banca de cocina) Pour surfaces especiales (ex. plan de travail de cuisine) Für spezielle Oberflächen (Beispiel: Küchenarbeitsplatten)	ENSAIO POR SOLICITAÇÃO test upon request ensayo por solicitacion essai sur demande Probe bei Anfrage	NP EN ISO 10545-15	
	RESISTÊNCIA AO ESCORREGAMENTO anti-slip features (slipperiness) resistencia al deslizamiento anti-glissee Gleitwiderstand	ENSAIO POR SOLICITAÇÃO test upon request ensayo por solicitacion essai sur demande Probe bei Anfrage	A CONFIRMAR CASO A CASO to be confirmed a confirmar caso a caso à confirmer bestätigen	DIN 51130 DIN 51097 ENV 12633	

Tous les produits certifiés sont classés P3 E3 C2.

NÃO SE ACEITAM RECLAMAÇÕES DEPOIS DO MOSAICO CERÂMICO APLICADO. | No claims accepted after ceramic tiles are fixed. | No se aceptan reclamaciones después de estar aplicado el material.
Aucune réclamation ne sera acceptée après la pose du carrelage. | Nach dem Verlegen der Fliesen werden keine Reklamationen angenommen.

	EN14411; Anexo G; grupo group groupe B ₃	VALOR / TOLERÂNCIAS DA NORMA Standard Required by the Norm Valor / Tolerâncias de la Norma Valeur Prescrite de la Norm von den Normen vorgeschriebener Wert	VALOR MÉDIO GRESPOR Mean Value Valor medio Valeur Moyenne Mittelwert	NORMA DE ENSAIO Test Norm Norma de ensayo Norme d'Essai Norm der Probe													
	CARACTERÍSTICAS DIMENSIONAIS dimensional characteristics características dimensionales caractéristiques mesurables dimensionale Eigenschaften	DIMENSÕES LINEARES linear dimensions • dimensiones lineales dimension linéaires • Länge und Breite	$\Delta \pm 0,6\%$ Max. $\pm 2\text{mm}$	$\pm 0,2\%$ excepto 10x10cm: $\pm 0,3\%$ except/ excepto/ sauf/ außer													
		ORTOGONALIDADE orthogonality • ortogonalidad orthogonalité • Orthogonalität	$\Delta \pm 0,5\%$ Max. $\pm 2\text{mm}$	$\pm 0,3\%$													
		RECTILINEARIDADE straightness of edges • rectilinealidad rectitude des chants • Geradlinigkeit	$\Delta \pm 0,5\%$ Max. $\pm 1,5\text{mm}$	$\pm 0,2\%$	NP EN ISO 10545-2												
		PLANARIDADE flatness • planidad planeité • Ebenflächigkeit	$\Delta \pm 0,5\%$ Max. $\pm 2\text{mm}$	$\pm 0,2\%$													
		ESPESSURA thickness • espesor épaisseur • Stärke	$\Delta \pm 5\%$ Max. $\pm 0,5\text{mm}$	$\pm 3\%$ excepto 60x60cm: $\pm 0,4\text{mm}$ except/ excepto/ sauf/ außer													
	ABSORÇÃO DE ÁGUA % water absorption in % absorción de agua en % absorption d'eau en % Wasseraufnahme in gew %	$E_w \leq 0,5\%$ Max. indiv. 0,6%	$\leq 0,1\%$	NP EN ISO 10545-3 (Método Vácuo) (Vacuum Method)													
	RESISTÊNCIA MECÂNICA À FLEXÃO EM N • MÓDULO DE RUPTURA N / mm ² breaking strength in N • rupture modulus N / mm ² resistencia mecánica a la flexión en N • modulo de ruptura N / mm ² résistance à la flexion en N • module de rupture N / mm ² Biegefestigkeit in N • Bruchmodul N / mm ²	$<7,5\text{mm}$ $\geq 700\text{N}$ $\geq 7,5\text{mm}$ $\geq 300\text{N}$	$\geq 35\text{N/mm}^2$ Min. indiv. 32N/mm ²	<table border="1"> <tr> <td>(7,8mm) $\geq 1600\text{N}$</td> <td>(10,0mm) $\geq 2200\text{N}$</td> </tr> <tr> <td>(8,3mm) $\geq 1800\text{N}$</td> <td>(10,5mm) $\geq 2600\text{N}$</td> </tr> <tr> <td>(8,7mm) $\geq 1900\text{N}$</td> <td>(11,0mm) $\geq 3300\text{N}$</td> </tr> <tr> <td>(9,0mm) $\geq 2000\text{N}$</td> <td>(12,0mm) $\geq 3700\text{N}$</td> </tr> <tr> <td>(9,2mm) $\geq 2100\text{N}$</td> <td>(14,0mm) $\geq 5000\text{N}$</td> </tr> <tr> <td>(9,5mm) $\geq 2100\text{N}$</td> <td></td> </tr> </table> $\geq 45\text{N/mm}^2$ / $\geq 460\text{Kg/cm}^2$ V. Médio Grespor: 52N/mm ²	(7,8mm) $\geq 1600\text{N}$	(10,0mm) $\geq 2200\text{N}$	(8,3mm) $\geq 1800\text{N}$	(10,5mm) $\geq 2600\text{N}$	(8,7mm) $\geq 1900\text{N}$	(11,0mm) $\geq 3300\text{N}$	(9,0mm) $\geq 2000\text{N}$	(12,0mm) $\geq 3700\text{N}$	(9,2mm) $\geq 2100\text{N}$	(14,0mm) $\geq 5000\text{N}$	(9,5mm) $\geq 2100\text{N}$		NP EN ISO 10545-4
(7,8mm) $\geq 1600\text{N}$	(10,0mm) $\geq 2200\text{N}$																
(8,3mm) $\geq 1800\text{N}$	(10,5mm) $\geq 2600\text{N}$																
(8,7mm) $\geq 1900\text{N}$	(11,0mm) $\geq 3300\text{N}$																
(9,0mm) $\geq 2000\text{N}$	(12,0mm) $\geq 3700\text{N}$																
(9,2mm) $\geq 2100\text{N}$	(14,0mm) $\geq 5000\text{N}$																
(9,5mm) $\geq 2100\text{N}$																	
	RESISTÊNCIA À ABRASÃO PROFUNDA deep scratch resistance resistencia a la abrasión profunda résistance à l'abrasion profonde Bestimmung des Widerstandes g. tiefen Verschleiß	NÃO VIDRADOS Unglazed Tiles No esmaltadas Carreaux non émaillés Unglasierte Fliesen	$\leq 175\text{mm}^3$	130mm ³	NP EN ISO 10545-6												
	DILATAÇÃO TÉRMICA LINEAR (x10 ⁻⁶ °K ⁻¹) linear thermal dilatation (x10 ⁻⁶ °K ⁻¹) dilatación térmica lineal (x10 ⁻⁶ °K ⁻¹) dilatation thermique linéaire (x10 ⁻⁶ °K ⁻¹) Wärmeausdehnungskoeffizient (x10 ⁻⁶ °K ⁻¹)			$\leq 7 \times 10^{-6} \text{ K}^{-1}$	NP EN ISO 10545-8												
	RESISTÊNCIA AO CHOQUE TÉRMICO resistance to thermal shock resistencia al choque térmico résistance aux écarts thermiques Widerstand bei Temperaturwechsel			RESISTENTE resistente resistente resistant Widerstandsfähig	NP EN ISO 10545-9												
	RESISTÊNCIA AO GELO frost resistance resistencia al hielo résistance au gel Frostbeständigkeit	NÃO DEVE APRESENTAR ROTURA OU ALTERAÇÃO NA SUPERFÍCIE must not produce noticeable alterations to surface no debe presentar rotura o alteración en la superficie ne doivent pas présenter d'alterations considerables de la surface Oberflächen dürfen keinen Bruch oder Schaden aufweisen		RESISTENTE resistente resistente resistant Widerstandsfähig	NP EN ISO 10545-12												
	RESISTÊNCIA A PRODUTOS DOMÉSTICOS DE LIMPEZA E ADITIVOS PARA PISCINAS resistance to household products and swimming-pool additives resistencia a los productos domésticos de limpieza y aditivos para piscinas résistance aux produits d'entretien ménagers et produits chimiques pour piscine Beständigkeit gegen Haushaltsreiniger und Schwimmbadzusätze	min. classe B minimum class B		GARANTIDO guaranteed garantizado garantie garantiert	NP EN ISO 10545-13												
	RESISTÊNCIA AOS ÁCIDOS E BASES DE BAIXAS/ ALTAS CONCENTRAÇÕES resistance to low/ high concentrations of acids and alkalis resistencia a los ácidos y bases de bajas/ altas concentraciones résistance aux acides et bases de faible/ haute concentration Säurewiderstand auf Grundlage der niedrigeren/ höheren Konzentration	REPORTAR CLASSIFICAÇÃO P/ BAIXAS CONCENTRAÇÕES / FACULTATIVO P/ AS ALTAS CONCENTRAÇÕES. To inform classification for low concentration of acid and alkalis resistance / facultative for high concentrations of acid and alkalis resistance. Reportar clasificación p/ bajas concentraciones / facultativo p/ as altas concentraciones. À indiquer la classification à résistance aux acide et bases de faible concentration / facultatif pour la résistance aux acide et bases de haute concentration. Klassifikation für niedrige Konzentrationen angeben / fakultativ für hohe Konzentrationen.		A CONFIRMAR CASO A CASO to be confirmed a confirmar caso a caso à confirmer bestätigen	NP EN ISO 10545-13												
	RESISTÊNCIA ÀS MANCHAS resistance to staining resistencia a las manchas résistance aux taches Fleckbeständigkeit	NÃO VIDRADOS: DECLARAR VALOR Unglazed Tiles: Declare Value No esmaltadas: declarar valor Carreaux non émaillés: Déclarer Valeur Unglasierte Fliesen: Wert angeben		\geq classe 2	NP EN ISO 10545-14												
	LIBERTAÇÃO DE CHUMBO E CÁDMIO cadmium and lead release liberación de plomo y cadmio libération de cadmium et plomb Befreiung von Blei und Kadmium	PARA SUPERFÍCIES ESPECIAIS (EX. BANCADA DE COZINHA) For special surfaces (ex. kitchen counters) Para superficies especiales (ex. banca de cocina) Pour surfaces especiales (ex. plan de travail de cuisine) Für spezielle Oberflächen (Beispiel: Küchenarbeitsplatten)		ENSAIO POR SOLICITAÇÃO test upon request ensayo por solicitud essai sur demande Probe bei Anfrage	NP EN ISO 10545-15												
	RESISTÊNCIA AO ESCORREGAMENTO ** anti-slip features (slipperiness) ** resistencia al deslizamiento ** anti-glisse ** Gleitwiderstand **	ENSAIO POR SOLICITAÇÃO test upon request ensayo por solicitud essai sur demande Probe bei Anfrage		A CONFIRMAR CASO A CASO to be confirmed a confirmar caso a caso à confirmer bestätigen	DIN 51130 DIN 51097 ENV 12633												

** Tests efetuados por laboratórios exteriores acreditados cujos resultados estão disponíveis na nossa sede sob solicitação. A Pavigrés está disponível para testar nos seus laboratórios qualquer lote de mercadorias adquirido.

** Tests carried out by certified external laboratories whose results are available upon request at Head office. Pavigrés is available to prove in our own laboratories the technical characteristics of any purchased lot upon request.

** Tests effectués par des laboratoires extérieurs accrédités et à la disposition de toute personne intéressée auprès de nos bureaux. Pavigrés est disponible pour confirmer dans ses laboratoires les caractéristiques d'un lot de marchandises achetées sur demande.

** Prüfungen, die von zertifizierten externen Labors durchgeführt werden, deren Ergebnisse auf Anfrage in unserem Büro erhältlich sind. Pavigrés ist bereit um in seinen eigenen Labors die technischen Eigenschaften eines erworbenen Fertigungsglases auf Anfrage zu beweisen.

Tous les produits certifiés sont classés E3 C2.

Os produtos com absorção <0,5% são classificados segundo a norma UNI CEN "Fully Vitrified Tiles" e segundo a norma ASTM "Impervious Tiles".

The products having an absorption <0,5% are classified according to the UNI CEN standards "Fully Vitrified Tiles" and according to the ASTM "Impervious Tiles".

Los productos con absorción <0,5% son clasificados segundo la norma UNI CEN "Fully Vitrified Tiles" y segundo la norma ASTM "Impervious Tiles".

Les produits avec absorption <0,5% sont classés selon les normes UNI CEN "Fully Vitrified Tiles" et selon les normes ASTM "Impervious Tiles".

Die Erzeugnisse mit einer Absorption <0,5% sind gemäß den UNI CEN-Normen "Fully Vitrified Tiles" und gemäß den ASTM-Normen "Impervious Tiles" klassifiziert.

NÃO SE ACEITAM RECLAMAÇÕES DEPOIS DO MOSAICO CERÂMICO APLICADO. | No claims accepted after ceramic tiles are fixed. | No se aceptan reclamaciones después de estar aplicado el material.
Aucune réclamation ne sera acceptée après la pose du carrelage. | Nach dem Verlegen der Fliesen werden keine Reklamationen angenommen.



APÓS A APLICAÇÃO DOS MOSAICOS E RESPECTIVA JUNTA É DE EXTREMA IMPORTÂNCIA EFECTUAR AS OPERAÇÕES DE LIMPEZA DE OBRA, DE FORMA A ELIMINAR OS RESÍDUOS DE APLICAÇÃO (CIMENTOS, COLAS, JUNTAS, TINTAS) BEM COMO POSSÍVEIS RESÍDUOS SUPERFICIAIS DO MATERIAL. RECOMENDA-SE QUE, IMEDIATAMENTE APÓS A JUNTA SECAR, SE LIMPE OS EXCESSOS DESTES PRODUTOS COM UM PANO HUMEDECIDO (SEGUINDO SEMPRE AS INDICAÇÕES DO FABRICANTE). A MAIORIA DOS PROBLEMAS MANIFESTADOS APÓS A OBRA DEVE-SE A UMA MÁ E POR VEZES INEXISTENTE LIMPEZA APÓS A APLICAÇÃO – PARA ESTE TIPO DE LIMPEZA RECOMENDAMOS UM DESINCRUSTANTE DE BASE ÁCIDA; NA LIMPEZA QUOTIDIANA DO MATERIAL RECOMENDAMOS A UTILIZAÇÃO DE DETERGENTE NEUTRO E NA LIMPEZA DE MANCHAS ESPECÍFICAS, CONSULTAR A TABELA:

After laying the tiles and grouting it is of utmost importance to perform the final cleaning procedures in order to eliminate any remaining residues (Cement, Grout , Glue, Paint) and also any other possible superficial residues. It is recommended that, immediately after the grout dry; the tile fixer should wipe the excess with a wet cloth (always following the manufacturer's instructions). Most of the noticed problems, once the laying works are complete, are due to inefficient / non existing cleaning procedures - for this type cleaning procedures we recommend an acid based detergent; on the daily cleaning procedures we recommended the use of a neutral detergent. For specific cleaning, kindly check the chart:

Después de rejuntar los mosaicos es de extrema importancia efectuar las operaciones de limpieza de obra, de forma que se eliminen los residuos de la aplicación (cementos, juntas, colas, tintas) así como posibles residuos superficiales en el material. Se recomienda que, inmediatamente después de secarse la junta, se limpie el exceso de estos productos con un paño húmedo (siguiendo siempre las indicaciones del fabricante). La mayoría de los problemas manifestados después de la obra se debe a una mala o inexistente limpieza después de la aplicación - para este tipo de limpieza recomendamos un desincrustante de base ácida; en la limpieza cotidiana del material recomendamos la utilización de detergente neutro y en la limpieza de manchas específicas, consultar la tabla:

Après pose et jointement des carreaux, il est extrêmement important d'effectuer les opérations de nettoyage de fin de chantier afin d'éliminer tous résidus (ciment, joint, colles et peintures), même superficiels, de la mise en œuvre. Il est conseillé que, immédiatement après le séchage du joint, que le surplus des produits soient retirés à l'aide d'un torchon humide (en suivant toujours les indications du fabricant). La plupart des problèmes qui surgissent après la fin du chantier sont dus à un mauvais voir inexistant nettoyage après application - pour ce nettoyage nous recommandons un déincrustant à base d'acide; pour le nettoyage quotidien du matériel nous recommandons l'utilisation de nettoyant neutre et pour les taches plus spécifique voir tableau ci-dessous:

Nach dem Verlegen und Ausfügen der Fliesen ist es sehr wichtig die Reinigungsvorgänge durchzuführen, damit alle Rückstände beseitigt werden (Mörtel, Fugen, Klebstoffe, Tintenflecke) sowie eventuelle oberflächliche Rückstände. Nachdem die Fuge trocken ist, sollen die Reste sofort mit einem nassen Tuch gereinigt werden (immer die Anweisungen vom Hersteller folgend). Die meisten angebrachten Problemen nach den Arbeiten stammen aus eine schlechte und oft inexistente Reinigung nach dem Verlegen - Für diese Reinigung empfehlen wir Kesselsteinlösemittel mit Säure; bei der tägliche Reinigung empfehlen wir die Verwendung von neutral Reinigungsmittel und bei der Reinigung von spezifische Flecken bitte u.a. Anweisungen sehen:

TIPO DE SUJIDADE type of stain tipo de suciedad type de saleté Art. der Verschmutzung	DETERGENTE OU SOLVENTE ACONSELHADO type of detergent advised detergente o disolventes aconsejados type de détergent ou de solvant conseillé empfohlenes Reinigungsmittel oder Pflegemittel	PRODUTOS RECOMENDADOS PELA FILA products advised by FILA productos recomendados pela FILA produit recommandé par FILA Von FILA empfehlende Reinigungsmittel
DEPÓSITOS/ EFLORESCÊNCIAS DE CALCÁRIO TINTA DE TINTEIRO FERRUGEM OXIDAÇÃO CIMENTO calcareous matter/ deposits ink rust and oxides mortar deposits/ eflorescencias de carbonato cálcico tinta de tintero herrumbre oxidación cemento dépôts/ efflorescences de calcaire encres rouille et oxydation mortier Kalkablagerungen/ Ablagerungen Tinte Rost und Oxydation Mörtel	DETERGENTE COM BASE ÁCIDA: ÁCIDO MURIÁTICO ÁCIDO NÍTRICO ÁCIDO SULFÚRICO ÁCIDO OXÁLICO acid detergent: hydrochloric acid: muriatic acid sulphuric acid oxalic acid detergente con base ácida: ácido muriático ácido nítrico ácido sulfúrico ácido oxalico acide: acide muriatique acide nitrique acide sulfurique acide oxalique Säurehaltiges Reinigungsmittel: Salzsäure Salpetersäure Schwefelsäure Oxalsäure	ETERDEK
CERVEJA/ VINHO GELADO E CAFÉ CHÁ GORDURA VEGETAL E ANIMAL URINA VÔMITO beer/ wine ice cream and coffee tea vegetable and animal fat urine vomit cerveza/ vino helado y café té grasa vegetal y animal orina vómito bière/ vin glace et café thé graisses végétales et animales urine vomissement Bier/ Wein Eis und Kaffee Tee tierische oder pflanzliche Fette Urin Erbrochenes	DETERGENTE COM BASE ALCALINA: SODA CÁUSTICA POTASSA alkaline detergent: caustic soda potash detergente con base alcalina: sosa cáustica potasa détergents alcalins: soude caustique potasse Säurehaltiges Reinigungsmittel: Ätznatron Kohlensäures Kali	FILA PS/87 FILA SR/95
MARCA DE PNEU TINTAS RESINOSAS OU ESMALTE ÓLEO VERNI ZES GRAXA LÁPIS DE CERA TINTA DE CABELLO BATON BETUMES CERAS RESINAS rubber paints grease varnish shoe polish wax crayon hair dye lipstick putties wax resins marca de pie tintas resinosas o esmalte óleo barnices betún ceras de colores tinta para cabelos carmin de labios alquitran ceras resinas caoutchouc de pneus/ peinture huile de graissage vernis cire/ crayon de papier teinture pour les cheveux rouge à lèvres bitume cires resines Gummi Harz oder Lack Maschinenöl Lack Schmiere Wachsstift Haarfarbe Lippenstift Bitumen Wachs Harz	SOLVENTES: TRIELINA DILUENTE AGUARRÁS ACETONA solvent detergent: turpentine oil of turpentine thinner trichloroethylen detergente disolventes: trielina diluyente aguarrás acetona détergents solvants: trichloréthylène dissolvant acétone térébenthine Lösungsmittel: Trichloräthylen Nitroverdüner Terpentin Azeton	FILA PS/87 FILA SR/95 FILANOSPOT (ÓLEO GRAXA) (grease shoe polish) (óleo betún) (huile de graissage cire) (Maschinenöl Schmiere) FILASOLV (BETUMES, CERAS E RESINAS) (alquitran ceras resinas) (putties wax resins) (betume cires resines) (Bitumen Wachs Harz)
CANETAS DE FELTRO KETCHUP COCA-COLA VINAGRE AZUL METILENO felt tipped pen ketchup coke vinegar methylene blue rotuladores ketchup coca cola vinagre azul metileno feutres ketchup coca-cola vinaigre bleu de méthylène Filzstift Ketchup Coca-Cola Essig Methylene blau	DETERGENTE COM BASE ALCALINA ÁCIDO alkaline detergent acid detergent detergente con base alcalina ácido détergent alcalin acide alkalisch säurehaltiges Reinigungsmittel	FILA PS/87 FILA SR/95
TINTAS DE GRAFITI graffiti pintadas de grafiti graffitis Graphitfarben		FILA NOPAINT STAR
SUJIDADE NAS JUNTAS dirt on grouting joints suciedad en las juntas sallisures sur les joints Fugenschmutz		FUGANET
MANUTENÇÃO QUOTIDIANA daily cleaning manutención cotidiana maintenance journalière tägliche Reinigung	DETERGENTE COMUM normal detergent detergente común détergent normal gewöhnliches Reinigungsmittel	FILACLEANER

USAR COM MUITA PRUDÊNCIA ÁCIDOS E OUTROS PRODUTOS QUÍMICOS CONCENTRADOS. SEGUIR ATENTAMENTE AS INSTRUÇÕES DOS FABRICANTES INDICADAS NAS EMBALAGENS.

O GRÉS PORCELÂNICO TÉCNICO POLIDO (UGL), DA PAVIGRÉS É PROTEGIDO COM UM IMPERMEABILIZANTE ANTI-MANCHA, DE MODO A FACILITAR A SUA LIMPEZA DURANTE E APÓS A OBRA, NO ENTANTO, PODE NÃO SER SUFICIENTE, SE NÃO SE PROCEDER A UMA LIMPEZA CUIDADA E ATEMPADA DO MATERIAL. RECOMENDAMOS QUE SE INFORME CUIDADOSAMENTE E SE NECESSÁRIO CONTACTE O FABRICANTE ANTES DE SELECIONAR UM PRODUTO, PARA SE ASSEGURAR QUE ESCOLHE O PRODUTO CERTO PARA A UTILIZAÇÃO EM VISTA.

Use greatest caution whenever working with acids or other strong cleaning chemicals. Read product label carefully and always follow manufacturers directions and precautions.

The polished homogeneous technical porcelain tiles (UGL) of Pavigrés is treated with an anti-stain sealer in order to facilitate cleaning during and after the installation, however, it may not be sufficient, if it is not done a careful and timely cleaning of the material. We recommend that one should search for information and if necessary ask the manufacturer for advice before you select a product to make sure that you select the right tile for the envisaged use.

Usar con mucha prudencia ácidos o de otros químicos concentrados. Seguir atentamente las instrucciones de los fabricantes, indicados en los embalagens.

El grés porcelánico técnico pulido (UGL) de Pavigrés está protegido con un impermeabilizante antimanchas, que facilita su limpieza después de obra, pero puede no ser suficiente si no se procede a una limpieza cuidada y oportuna del material. Recomendamos que se informe cuidadosamente y si es necesario contacte con el fabricante antes de seleccionar un producto, para asegurar que se escoge el producto correcto para el uso al que va destinado.

Agir avec prudence dans l'emploi d'acides ou d'autres produits chimiques concentrés. Suivez attentivement les instructions des fabricants indiquées sur les emballages.

Le grés cérame technique poli (UGL) de chez Pavigrés est protégé avec un imperméabilisant anti tâche, de façon à faciliter son nettoyage durant et après le chantier, cependant, il est possible, que cela ne soit pas suffisant, si le nettoyage du matériel n'est pas fait de façon soignée et en temps nécessaire. Avant de sélectionner un ou plusieurs produits, nous recommandons la prise d'information et si nécessaire la prise de contact auprès du fabricant afin de s'assurer que ce choix est en accord avec l'utilisation prétenue.

Beim Umgang mit Säuren oder anderen Chemikalien ist Vorsicht geboten. Die Herstellerhinweise auf den Packungen strikt befolgen.

Die Technik polierte Feinsteinzeugfliese (UGL) von Pavigrés, ist mit einer Fleckenschutzfolie geschützt um die Reinigung während und nach der Verlegung zu erleichtern; trotzdem kann es vorkommen, daß diese nicht genügend ist wenn die Reinigung nicht sorgfältig und rechtzeitig gemacht wird. Wir empfehlen sich zuerst sorgfältig zu erkundigen und wenn nötig den Hersteller zu kontaktieren bevor Sie die Produkte aussuchen um sicher zu sein, daß Sie die, für den Gebrauch, geeignete Fliese auswählen.

- CAMPO OPERACIONAL COM PERIGO DE DESLIZE (TESTE EM SUPERFÍCIE INCLINADA).
Operation field with slip danger (test on incline surface).
Campo operacional con peligro de deslizamiento (test en superficie inclinada).
Champs opérationnels avec risque de glisse (test en surface inclinée).
Arbeitsbereich mit Rutschgefahr (Test auf schiefer Ebene).

DIN 51130

ZONA INDUSTRIAL | industrial area | polígono industrial | zone industrielle | Gewerbebereich



DIN 51097

ZONA "PÉ DESCALÇO" | bare-foot area | zona "pie desnudo" | zone "pied-nu" | "Barfuß" bereich

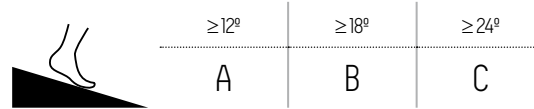

OS ÂNGULOS DE INCLINAÇÃO INDICADOS SERVEM EXCLUSIVAMENTE PARA ATRIBUIÇÃO DOS GRUPOS DE AVALIAÇÃO E NÃO SÃO EQUIPARADOS COM OS ÂNGULOS DE INCLINAÇÃO DE DECLIVES/RAMPAS.
The indicated incline angles are just for classification of the valuation groups, and they don't match to the incline angles of slopes.
Los angulos de inclinación indicados sirven exclusivamente para la atribución de los grupos de valoración y no son equiparables con los angulos de inclinación de declives/rampas.
Les angles d'inclinaison indiqués sont exclusivement pour l'attribution des comparés avec les angles d'inclinaison de pentes/rampes.
Die angegebenen Neigungswinkel dienen ausschließlich zur Zuordnung der Bewertungsgruppen und sind nicht mit den Neigungswinkeln von Schrägen/Rampen gleichzusetzen.

CLASSIFICAÇÃO DE PAVIMENTO . FLOOR CLASSIFICATION . CLASIFICACIÓN DE PAVIMENTO . CLASSIFICATION DE SOL . KLASSIFIKATION DES BODENBELAGES

- U. P. E. C.
CLASSIFICAÇÃO DE PAVIMENTO • floor classification • clasificación de pavimento • classification de sol • Klassifikation des Bodenbelages

U RESISTÊNCIA À ABRASÃO
scratch resistance
resistencia a la abrasión
résistance à l'abrasion
Verschleissfest

P RESISTÊNCIA MECÂNICA
breaking strength
resistencia mecanica
résistance à la flexion
Biegefestigkeit

E COMPORTAMENTO EM PRESENÇA DE ÁGUA
behaviour in water presence
comportamiento con presencia de agua
comportement en présence d'eau
Verhalten bei Wasseranwesenheit

C COMPORTAMENTO EM PRESENÇA DE PRODUTOS QUÍMICOS
behaviour in presence of chemical products
comportamiento con presencia de productos quimicos
comportement en présence de produits chimiques
Verhalten bei Chemikalien

UPEC
.....
U2
.....
U2S
.....
U3
.....
U3S
.....
U4
.....

O índice da letra U (resistência à abrasão) é relacionado com: a classificação PEI (pavimento vidrado).
The index of letter U (resistance to the abrasion) is related with: classification PEI (vitrified floor).
El índice de la letra U (resistencia a la abrasión) está relacionado con: a clasificación PEI (pavimento vidriado).
L'index de la lettre U (résistance à l'abrasion) est relié avec: la classification PEI.
der Buchstabe U (Verschleissfest) bezieht sich auf die: Klassifikation PEI.

clas. PEI
.....
PEI II
.....
PEI III
.....
PEI IV
.....
PEI V
.....



MATE . MATT . MAT

RETIFICADO (POLIDO E MACIO)
RECTIFIED (POLISHED AND HONED) . RECTIFICADO
(PULIDO Y MACIO)
RECTIFIÉ (POLI ET ADOUCIE) . REKTIFIZIERT (POLIERT
UND WEICH)

FORMATO NOMINAL mm NOMINAL SIZES . FORMATO NOMINAL FORMAT NOMINAL . NOMINAL FORMATE	B	C	D	E	F	B
97 x 97	95.3 »» 95.9	96.0 »» 96.6	96.7 »» 97.3	97.4 »» 98.0		
147 x 147	145.3 »» 145.9	146.0 »» 146.6	146.7 »» 147.3	147.4 »» 148.0	148.1 »» 148.7	
97 x 297	95.9 »» 96.3	96.4 »» 96.7	96.8 »» 97.2	97.3 »» 97.6	97.7 »» 98.1	
	293.8 »» 295.0	295.1 »» 296.3	296.4 »» 297.6	297.7 »» 298.9	299.0 »» 300.2	
197 x 197	194.8 »» 195.6	195.7 »» 196.5	196.6 »» 197.4	197.5 »» 198.3	198.4 »» 199.2	
297 x 297	293.8 »» 295.0	295.1 »» 296.3	296.4 »» 297.6	297.7 »» 298.9	299.0 »» 300.2	294.8 »» 295.2
447 x 447	442.3 »» 444.1	444.2 »» 446.0	446.1 »» 447.9	448.0 »» 449.8	449.9 »» 451.7	443.3 »» 443.7
297 x 597	293.8 »» 295.0	295.1 »» 296.3	296.4 »» 297.6	297.7 »» 298.9	299.0 »» 300.2	294.8 »» 295.2
	590.8 »» 593.2	593.3 »» 595.7	595.8 »» 598.2	598.3 »» 600.7	600.8 »» 603.2	591.8 »» 592.2
597 x 597	590.8 »» 593.2	593.3 »» 595.7	595.8 »» 598.2	598.3 »» 600.7	600.8 »» 603.2	591.8 »» 592.2
447 x 890						443.3 »» 443.7
						888.8 »» 889.2
597 x 1190						294.8 »» 295.2
						1185.8 »» 1186.2
890 x 890						888.8 »» 889.2
Calibres mais usuais. Common sizes. Calibres más comunes. Calibres les plus courants. für regelmässige Kalibern.						

Os produtos prensados, pressupõem uma junta de 3 mm para se conjugarem.

Os produtos rectificadados / polidos / Amaciados / Cortados, pressupõem uma junta de 2 mm para se conjugarem.

Pressed products require a joint of 3 mm to be combined.

Rectified products / polished / honed / cut, require a joint of 2 mm to be combined.

Les produits pressés présupposent un joint de 3 mm pour se conjuguer.

Les produits rectifiés/polis/adoucis ou coupés présupposent un joint de 2 mm pour se conjuguer.

Die gepressten Produkte erfordern eine Fuge von 3mm um kombiniert zu werden.

Die rektifizierten / polierten / erweichten / geschnittenen Produkte, erfordern eine Fuge von 2mm um kombiniert zu werden.



por favor consultar a nossa página de internet . please check packing details on our website . por favor consultar en nuestro website
merci de bien vouloir consulter notre site internet . Bitte besuchen Sie unsere Seite im Internet

www.pavigres.com

• CONFERÊNCIA || CHECKING THE MATERIAL || VÉRIFICATION || CONFERENCIA || ÜBERPRÜFUNG

Antes da aplicação, verifique se o material corresponde: ao modelo, à escolha (qualidade), ao lote (tonalidade), e ao calibre desejado. Verifique todas as caixas para ter a certeza que tudo está correcto. Conserve os dados do material impressos na embalagem. As reclamações depois do material aplicado não são aceites pela Pavigrés, caso o defeito seja visível antes da aplicação do material.

Prior to the installation, check if the material corresponds to the desired: model, choice (quality), class (shade) and calibre. Check all boxes to ensure that everything is correct. Keep record of the data of the material printed on the packaging. Any claims made after the material has been installed will not be accepted by Pavigrés whenever the defect was perceptible prior to the installation.

Avant toute application, il convient de vérifier si le matériau correspond: au modèle, au choix (qualité), au lot (le ton) et au calibre désiré. Vérifiez toutes les boîtes afin d'avoir la certitude que tout est correct. Conservez toutes les données imprimées sur l'emballage. Les réclamations une fois le matériau appliqué ne sont pas acceptées par Pavigrés dans le cas où le défaut serait visible avant l'application du matériau.

Antes de la aplicación, verifique si el material corresponde: al modelo, a la selección (calidad), al lote (tonalidad) y al calibre deseado. Verifique todas las cajas para tener la seguridad de que todo es correcto. Conserve los datos del material impresos en el embalaje. Pavigrés no acepta las reclamaciones una vez que el material sea aplicado, en caso de que el defecto sea visible antes de la aplicación del material.

Das Material vor jede Verlegung prüfen und feststellen ob es dem gewünschten: Muster, Wahl (Qualität), Brandfarbe (Tonalität) und Kaliber entspricht. Alle Kartons prüfen um sicher zu sein das alles stimmt. Alle auf die Kartons gedruckte Daten aufbewahren. Reklamationen nach der Verlegung der Fliesen werden nicht von Pavigrés angenommen falls das Defekt vor der Verlegung sichtbar sein sollte.

EXEMPLOS DE IMPRESSÃO EM CAIXA || EXAMPLES OF PRINTING IN BOX || EXEMPLES D'IMPRESSION SUR LA BOITE || BEISPIELE DES AUFDRÜCKEN AUF DIE KISTE

REVESTIMENTO UNICOLOR BRILHANTE . UNI GLOSSY WALL TILE . REVESTIMIENTO UNICOLOR BRILLANTE . FAÏENCE UNI BRILLANTE . GLÄNZENDE STEINGUT WANDFLIESEN UNI

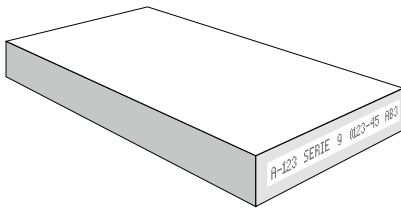

Referência Reference	Classe Choice Choix Wahl	Tonalidade Shade Nuance Farbton	Contr. int. Int. control Contr. int. Int. Kontrolle
A-123 SERIE COLOUR	9	0123-45	AB3

GRÉS VIDRADO . GLAZED VITRIFIED TILES . GRÉS VIDRIADO . GRÉS ÉMAILLÉ . GLASIERTES STEINZEUG

GRÉS PORCELÁNICO TÉCNICO . HOMOGENEOUS TECHNICAL PORCELAIN TILES . GRÉS PORCELÁNICO TÉCNICO . GRÈS CÉRAME TECHNIQUE . TECHNIK UNGLASIERTES FEINSTEINZEUG

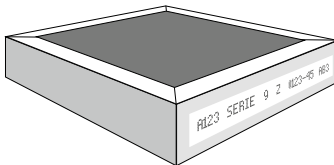

Referência Reference	Classe Choice Choix Wahl	Calibre Caliber Calibre Kaliber	Tonalidade Shade Nuance Farbton	Contr. int. Int. control Contr. int. Int. Kontrolle
A123 SERIE COLOUR	9	2	0123-45	AB3

	PAVIGRÉS21 UNI	PANTONE	RAL	NCS
	uni cereja	ref 7622	ref 3011	ref S 2570-R
	uni vermelho	ref 7621	ref 3000	ref S 1580-Y90R
	uni papoila	ref. warm red U		ref. S 0570-Y90R
	uni pergamon		ref. 9001	ref. S 1005-Y50R
	uni cristal		ref. 9003	ref. S 0500-N
	uni ébano		ref 9011	ref S 8005-R50B
	uni carvão	ref. black C	ref. 9004	ref. S 8500-N
	uni preto		ref 9005	ref S 8505-R80B
	uni metal	ref. 447 U		ref. S 7000-N
	uni estanho	ref. 404 U		ref. S 5500-N
	uni zinco	ref cool gray 5 C		ref S 3502-B
	uni prata	ref. cool gray 4 U		ref. S 2500-N
	uni névoa	ref 401 C	ref 7044	ref S 3502-Y
	uni caqui			ref S 5010-Y10R
	uni gelo	ref. 7527	ref. 9002	ref. S 1002-Y
	uni pérola	ref warm gray 1 U	ref. 1013	
	uni papiro			ref. S 2005-Y30R
	uni chocolate	ref. 4695 U	ref. 8017	ref. S 8010-Y50R
	uni cacau			ref. S 7010-Y50R
	uni moka	ref. 7531 C		
	uni cappuccino	ref 4745 C		ref S 3010-Y60R
	uni bege	ref. 4755 U		ref. S 2010-Y60R
	uni ouro	ref. 7407 C		ref. S 3040-Y20R
	uni caramelo	ref. 725 U	ref. 8003	ref. S 5040-Y50R
	uni salmão	ref 7521 C		ref S 3020-Y70R
	uni cotto		ref 8002	ref S 5020-Y70R
	uni baunilha		ref. 1001	ref. S 2010-Y30R
	uni amêndoa	ref. 728 C		ref. S 2020-Y40R
	uni papaia	ref. 717 U	ref. 2010	ref. S 2060-Y60R
	uni meloa	ref. 135 U	ref. 1034	ref. S 1060-Y30R
	uni ocre			ref S 2050-Y20R
	uni sol	ref. 106 U	ref. 1016	ref. S 0570-Y
	uni tangerina	ref. 1585 U		ref. S 0560-Y70R
	uni fénix	ref 1665	ref 2004	ref S 1080-Y70R
	uni gema	ref. 610 U		ref. S 1050-Y
	uni lima			ref. S 2050-G60Y
	uni musgo	ref 5757 U		ref S 5040-G60Y
	uni grama			ref S 3040-G40Y
	uni maçã	ref 578 U		ref S 1040-G40Y
	uni limonete			ref S 2010-G40Y
	uni trevo	ref 5625C		
	uni menta	ref. 5487 U		ref. S 5010-B70G
	uni turquesa	ref. 5517 U		ref. S 2010-B70G
	uni jade		ref 6033	ref S 4040-B50G
	uni tropical	ref 7721 C	ref 6004	ref S 5540-B50G
	uni mineral			ref S 4010-B10G
	uni céu	ref. 652 U		ref. S 3030-R80B
	uni lago	ref. 2945 U		ref. S 3050-R80B
	uni safira	ref 645 C		ref S 2040-R90B
	uni água	ref. 649 U		ref. S 2010-B
	uni navy	ref 2758 C	ref 5022	ref S 5540-R70B
	uni marine	ref 2747 U		ref S 3060-R70B
	uni lavanda	ref 7653 C		ref S 5010-R50B
	uni indigo	ref 7275 C		ref S 6020-R70B
	uni agapante	ref. 686 U		ref. S 2030-R40B
	uni púrpura	ref 519 U		ref S 5030-R50B
	uni alfazema	ref. 5165 U		ref. S 1020-R50B
	uni beringela	ref 7645 C		ref S 7020-R20B

PROJE

PROJECTS
PROYECTOS
PROJETS
OBJEKTE



EFFECTOS

HÔTEL ROYAL - THALASSO BARRIÈRE
LA BAULE - FRANCE

(Arch. François Bureau et Hugues d'Achon Architectes DPLG associés (44)

UNI ESTANHO
UNI METAL



"NEW AMSTERDAM" - NORWAY

UNI BAUNILHA
UNI MOKA
UNI NUVEM

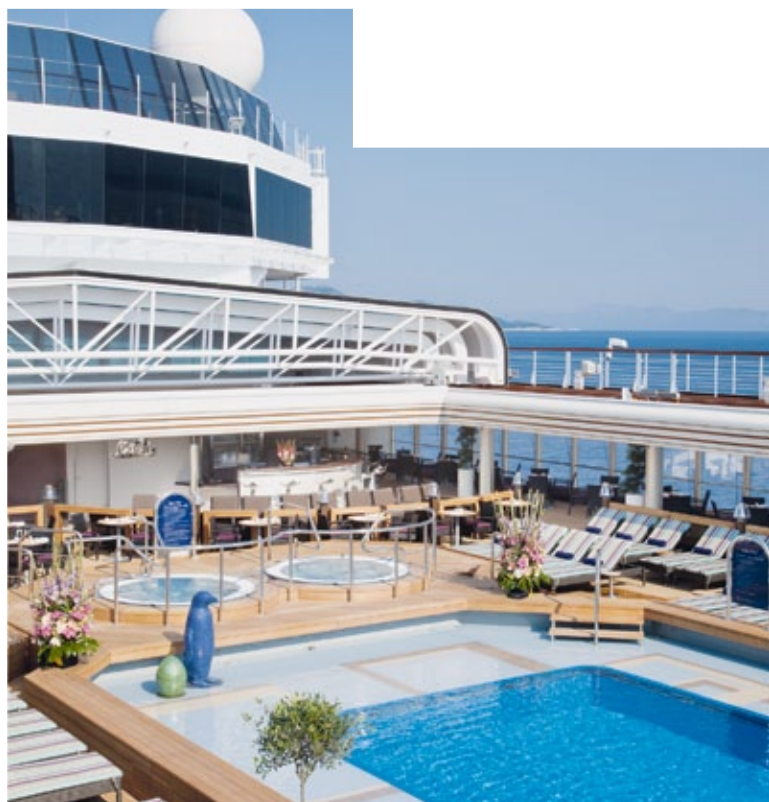

HOTEL SCANDIC ORNEN, BERGEN - NORWAY
Architect Niels Torp Arkitekter AS



HIO DUQUE DE LOULÉ BOUTIQUE HOTEL, LISBOA - PORTUGAL



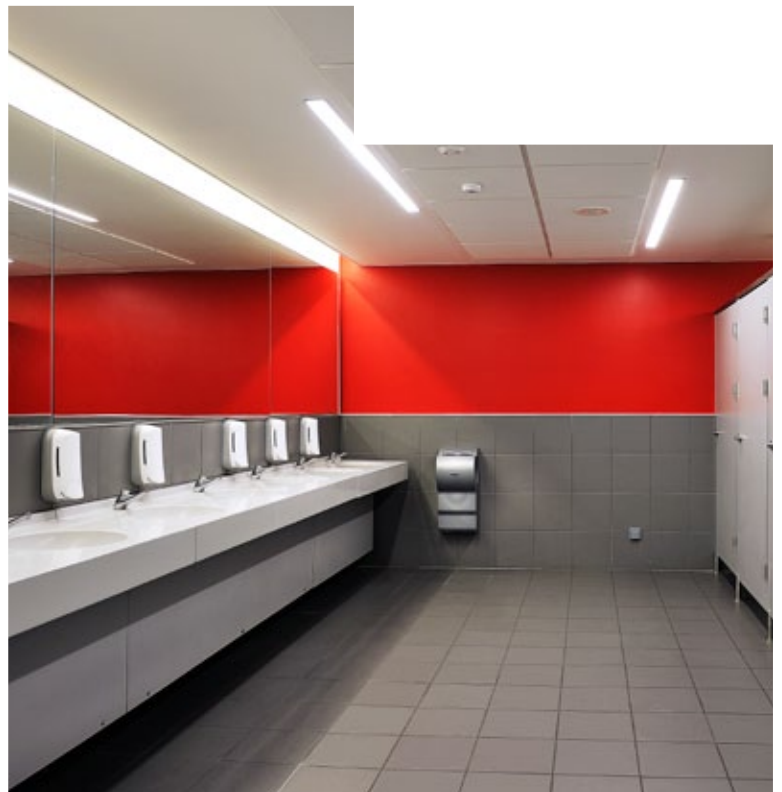
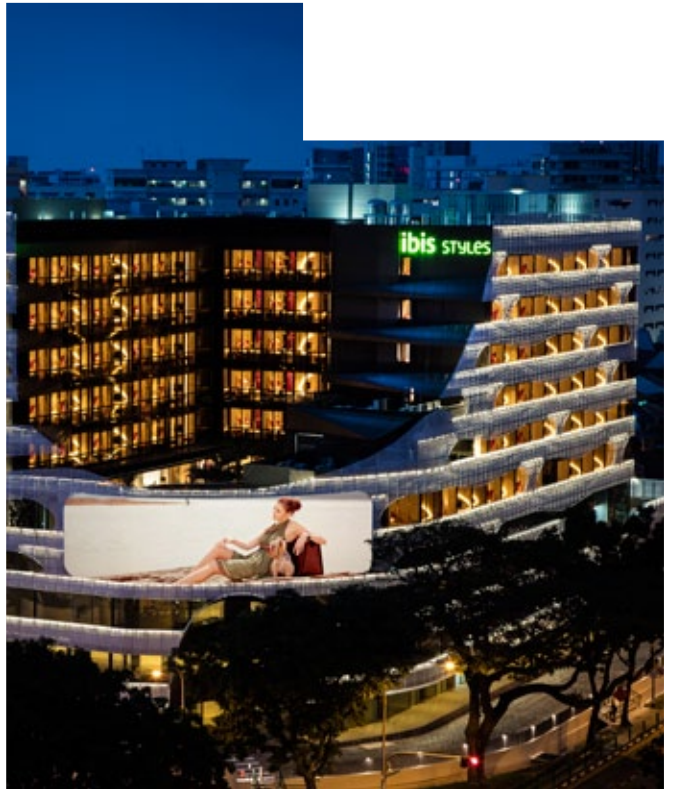

INFINITOS RECUERDOS DE DOÑA FELA, SAN JUAN - PUERTO RICO
Cero Design & Built, Inc.



PARQUE LUIS MUÑOZ MARIN, SAN JUAN - PUERTO RICO
Cero Design & Built, Inc.

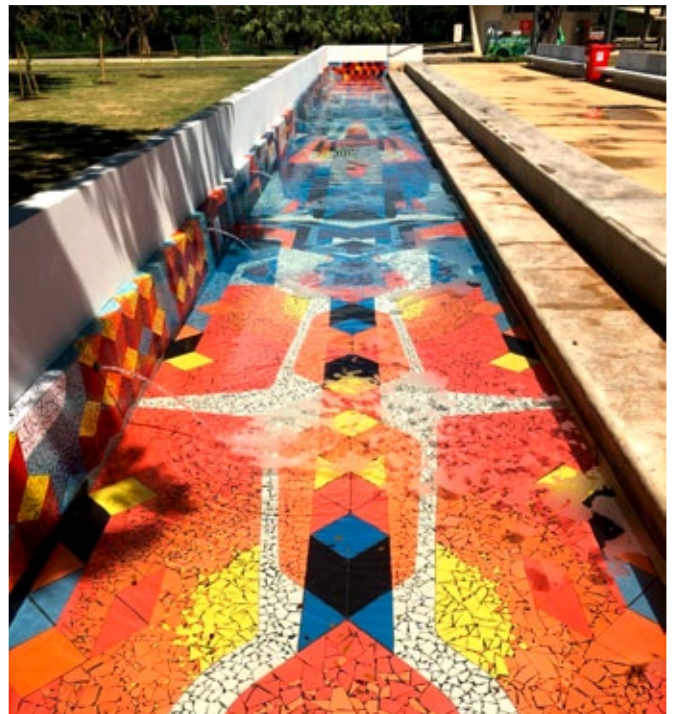

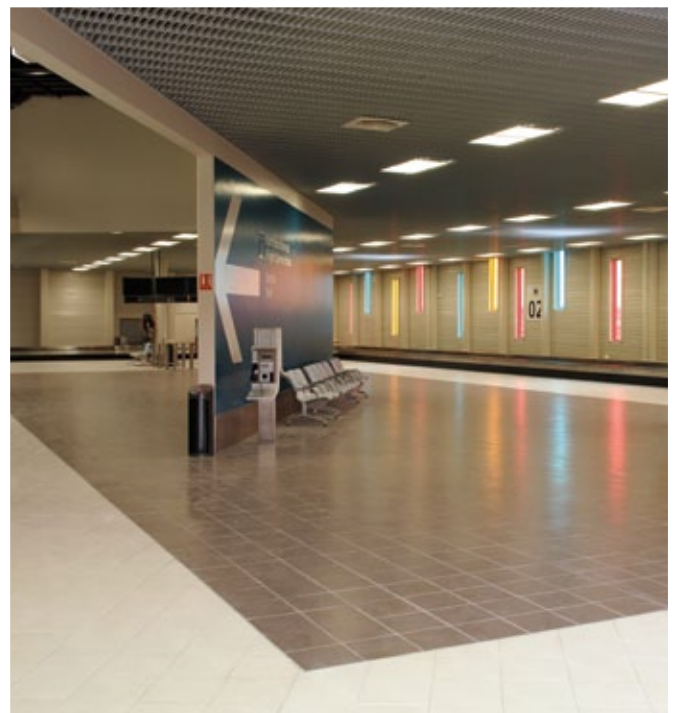

METRO STATION SOFIA NO2 - "BELI DUNAV", SOFIA, BULGARIA
Builder GP GROUP LTD,
Architect Mrs. Irena Derlipanska
Supplier MARTINELLI LTD

GRANO LIMA



STATION METRO ASTRID - ANVERS, BELGIUM

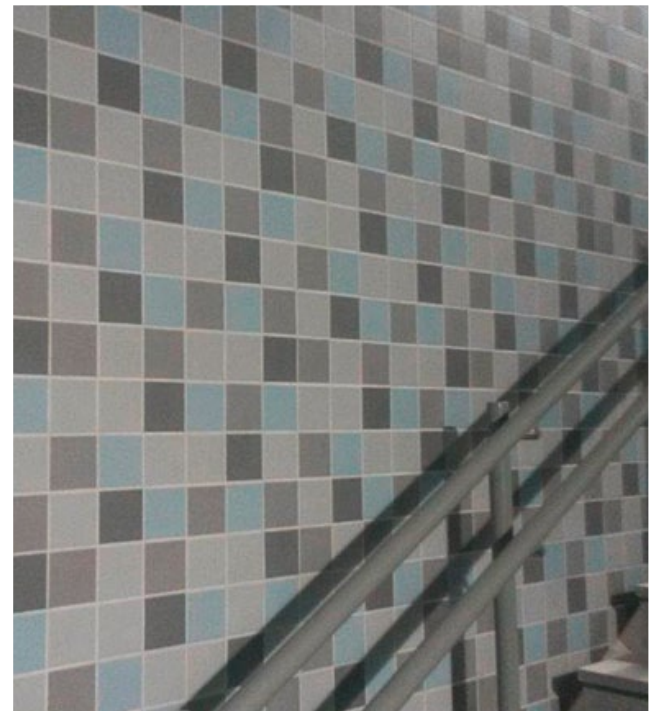
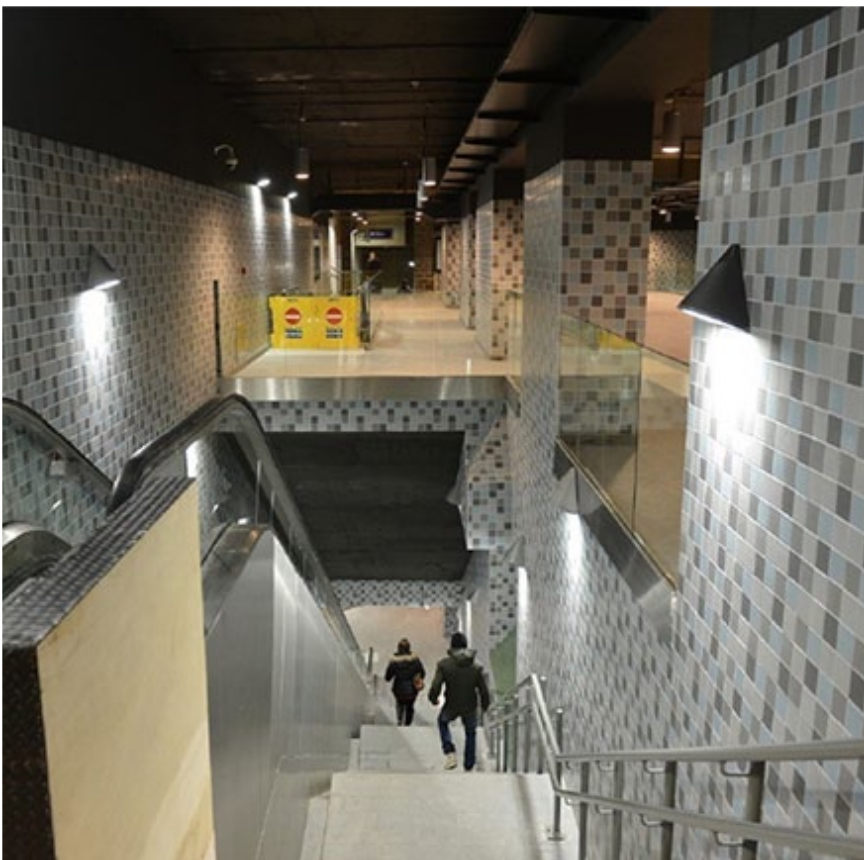

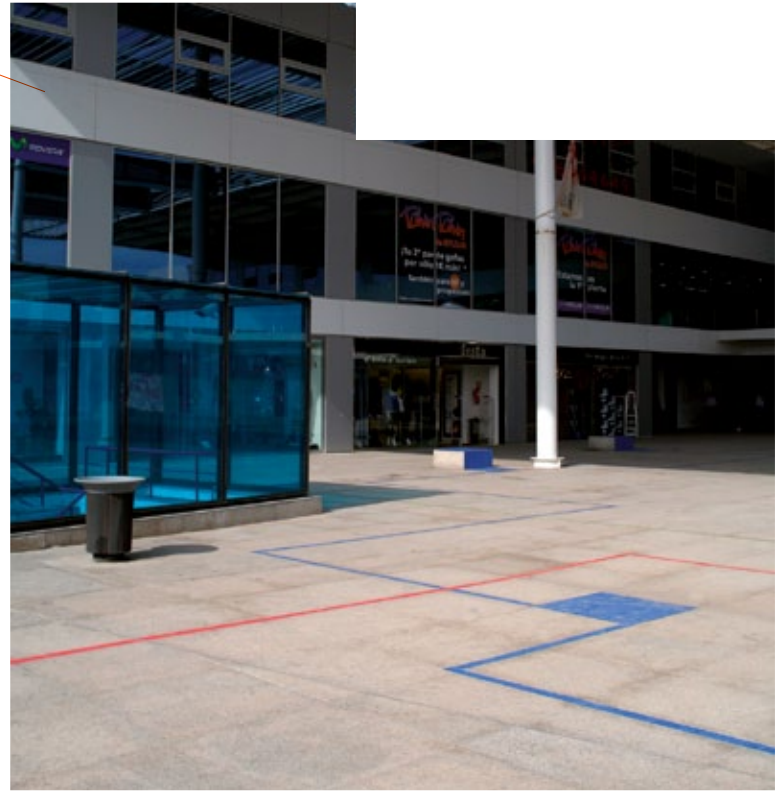

OCCI - ULLERN VGS - NORWAY
DARK Arkitekter AS , Arkitektpartner AS

GRANO GELO

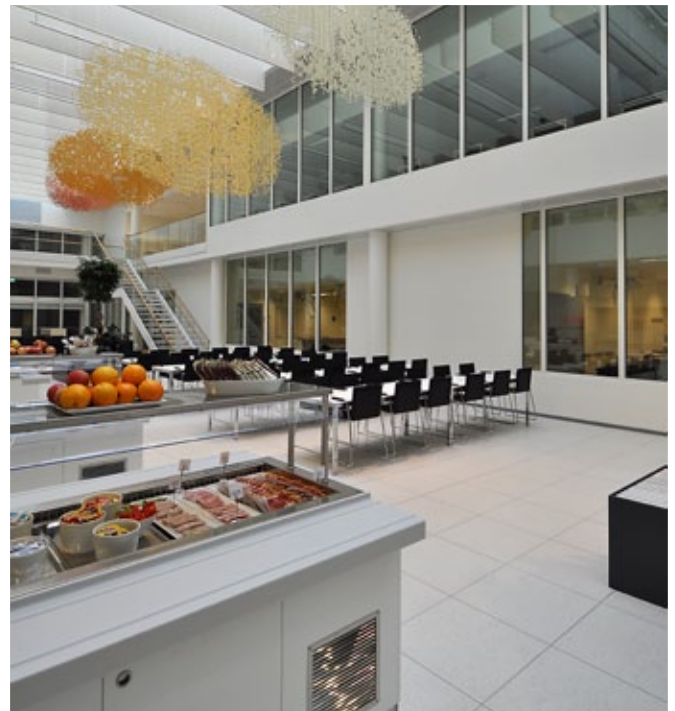
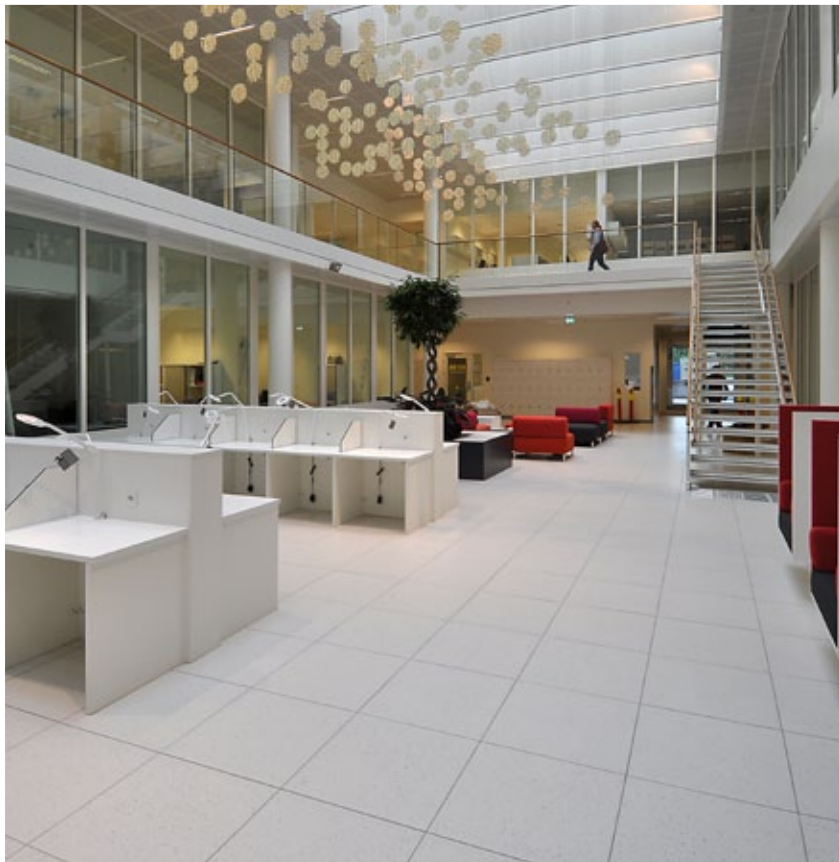



SHOPPING CENTRE "BAATA" - LATVIA
(“8 A.M.” SIA, Juris Lasis)

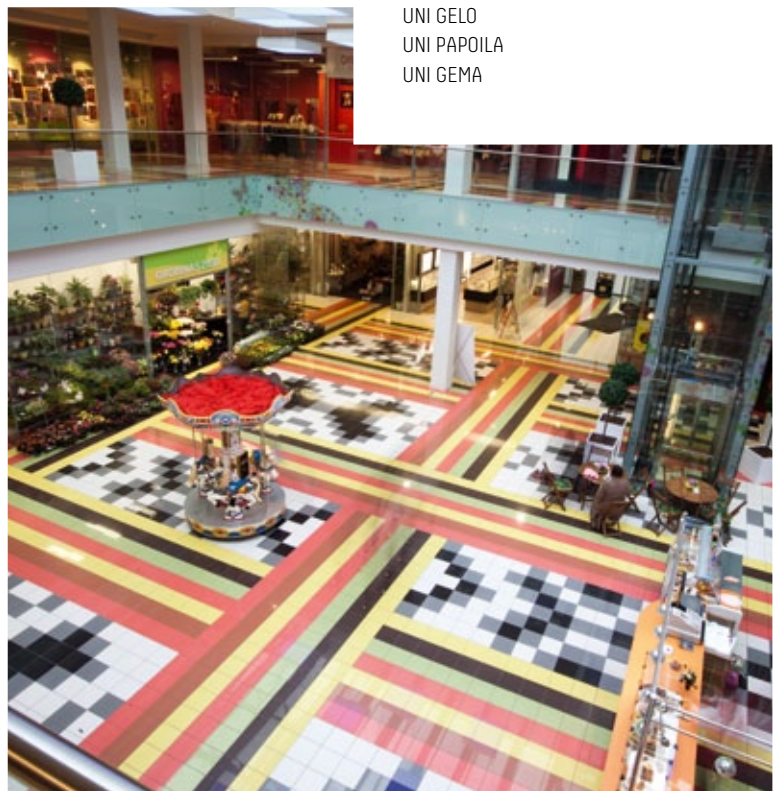

- UNI LAGO
- UNI CHOCOLATE
- UNI LIMA
- UNI TERRACOTA
- UNI CARVÃO
- UNI ESTANHO
- UNI GELO
- UNI PAPOILA
- UNI GEMA

SHOPPING CENTER IN VORONEG - RUSSIA



UNI MOKA
UNI GELO
GRANO GELO
UNI TERRACOTA
UNI LIMA
UNI GEMA
UNI CRISTAL



SANDVIKA STORSENTER
SHOPPINGMALL, OSLO - NORWAY



UNI GELO
GRANO GELO
UNI PÉROLA
GRANO MOKA



DER PEPPERGROR - NORWAY
Radius Design

UNI AGUA
UNI MINERAL
UNI OURO
UNI CARAMELO

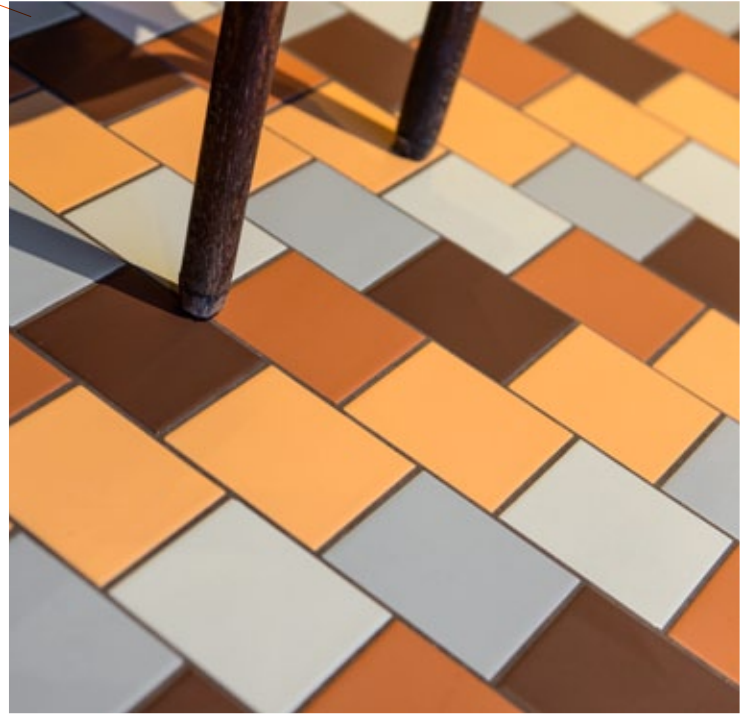

JAMIE OLIVIER'S RECIPEASE RESTAURANTS - LONDON, UK
Martin Brudnizki Design Studio

UNI MENTA
UNI MAR
UNI TURQUESA
UNI GELO
UNI METAL



MERCADO MUNICIPAL DE LOULÉ - PORTUGAL
(SIMAB - Sociedade Instaladora de
Mercados Abastecedores, S. A.)



UNI TERRACOTA
AD FINO BAUNILHA
FINO METAL
UNI GELO
UNI PRATA
UNI ESTANHO
UNI CARVÃO



INTERMARCHE DAX - FRANCE
Cabinet Diana



UNI GELO
FINO CARVAO
UNI MOKA



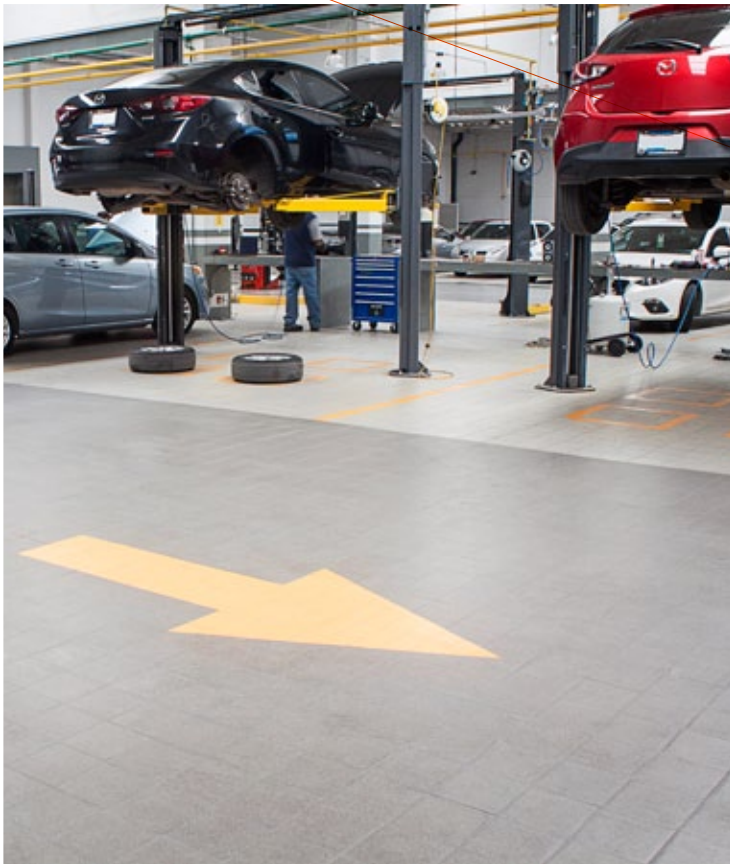

AUTOSTERN / MERCEDES, OSLO - NORWAY
Scenario/Kristin Jarmund Arkitekter AS



MARMITE D'OLIVIER - FRANCE



UNI PAPAIA
UNI ANÉMONA
UNI ALFAZEMA
UNI AGAPANTE
UNI SISÁLIS
UNI GEMA
UNI TANGERINA
UNI MELOA



BOCATERIA DINER - SPAIN

UNI SOL
UNI TANGERINA
UNI LAZULLI
UNI PAPOILA
UNI CRISTAL



WHITES DISPENSARY, PHARMACY - AUSTRALIA
Designer Studio Equator Builder Developer



UNI LIMONETE
UNI TREVO
UNI CARVÃO
UNI PAPIRO



NUCLEOS - SINGAPORE
Supplier: Gres Ceramics Pte Ltd



UNI MELOA
UNI TANGERINA
UNI BAUNILHA
UNI CRISTAL
UNI PRATA
UNI LIMA
UNI CÉU

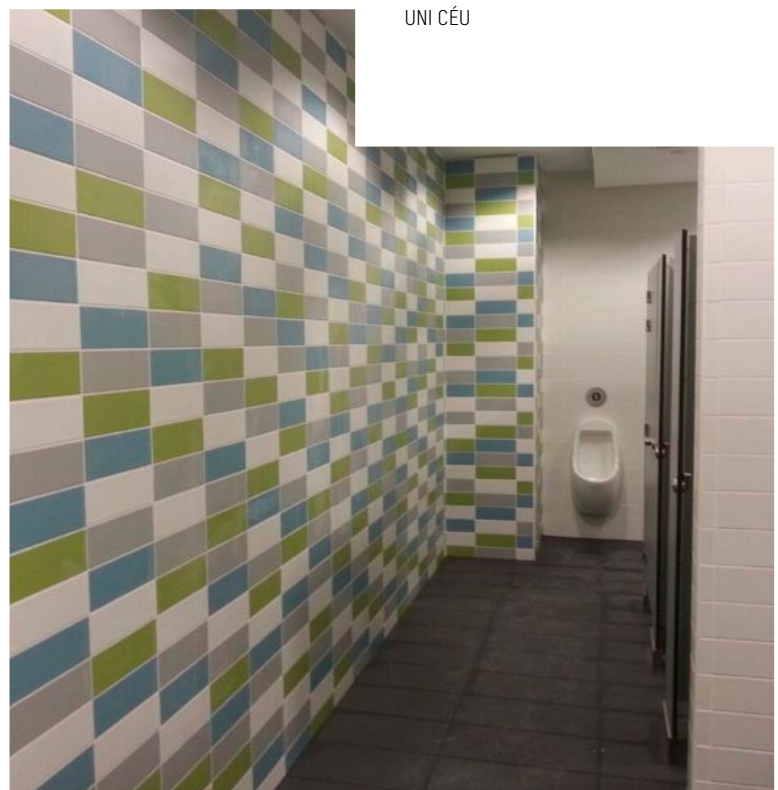



UNIVERSITY OF OSLO - NORWAY
Dyrø & Moen AS Arkitekter MNAL

UNI CARVÃO





LYCÉE PROFESSIONNEL ALBERT CHASSAGNE
PAIMBOEUF - FRANCE
(MO: Conseil Régional Des Pays De La Loire;
MOE: AJT Architecture et Trierdre Architecture)



- UNI TERRACOTA
- UNI PRATA
- UNI ESTANHO
- UNI METAL
- UNI GELO
- UNI CRISTAL
- UNI LIMA
- UNI GEMA
- FINO GELO
- FINO PRATA
- FINO ESTANHO
- FINO METAL



NO NYDALEN HIGH SCHOOL, OSLO - NORWAY
(ARCHITECT: Link Arkitektur AS)



LYCÉE CARCOUËT (44) - FRANCE
(MO: Conseil Régional de Pays de La Loire;
ARCHITECT: AJT Architecture Jacques Thibault et Didier Gaboriau)



LYCÉE DU SACRÉ COEUR - FRANCE
(Studio Stéphanie Daumer - 49)

UNI SOL
UNI LAZULI
UNI PAPOILA



COLLÈGE STENDHAL - FRANCE
(MO.: Conseil Général de Loire-Atlantique;
MOE: AIA Atelier de la Rize - arch. mandataire)

UNI METAL
UNI LIMA
UNI GEMA
UNI LAGO



© ARCHITECTES INGENIEURS ASSOCIES

ESCOLA EBI/ JI DR. SANCHES DE BRITO - PORTUGAL
(Arqº João Gois Ferreira e Arqº Gonçalo Teixeira)

UNI ESTANHO
UNI CRISTAL



ESCOLA SERPENTE
C.M. VILA NOVA DE GAIA - PORTUGAL
(Arqº João Botelho)

UNI ALFAZEMA
UNI GELO
UNI PRATA
GRANO GELO



ESCOLA MIRAMAR
C.M. VILA NOVA DE GAIA - PORTUGAL
(Arqº João Botelho)



UNI LAGO
UNI GEMA
UNI DUNA
GRANO DUNA
GRANO LIMA
GRANO NUVEM
GRANO PRATA

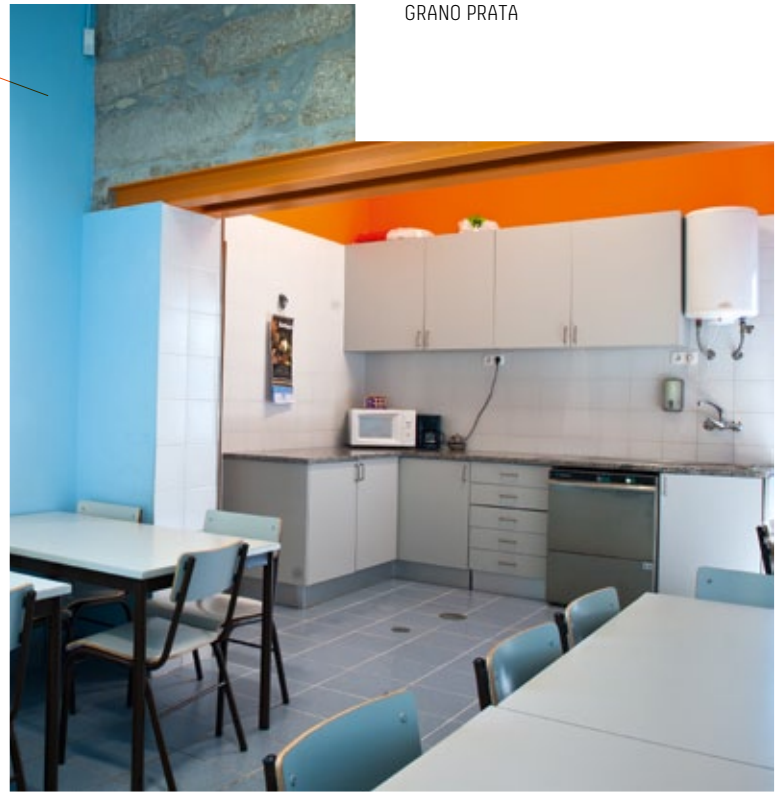

NATIONAL UNIVERSITY OF SINGAPORE



UNI ESTANHO
UNI GELO



ZENITH DE 44 NANTES - FRANCE
(Atelier d' Architecture Chaix & Morel et associés)



THÉÂTRE NATIONAL DE BRETAGNE
RENNES 35 - FRANCE
(Arch. Antoine Stinco)



UNI CARVÃO
UNI GELO



HÔPITAL SIMONE VEIL - EAUBONNE, MONTMORECY
(Emmanuelle Colboc, architecte)

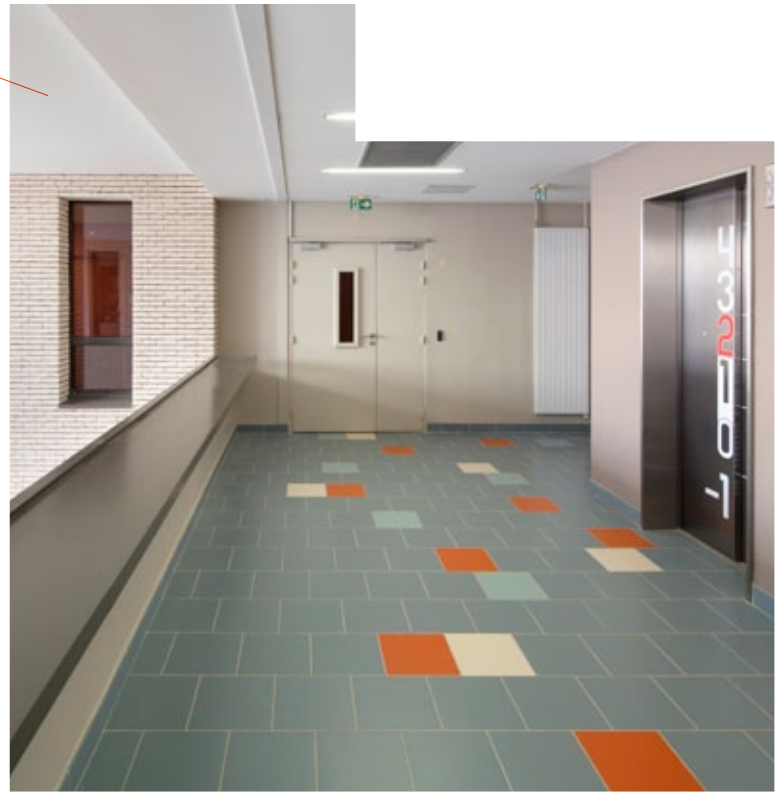

HOSPITAL SANTIAGO, SETÚBAL - PORTUGAL
(Arqª Sofia Novaes)

UNI CARVÃO
FINO GELO
UNI GELO



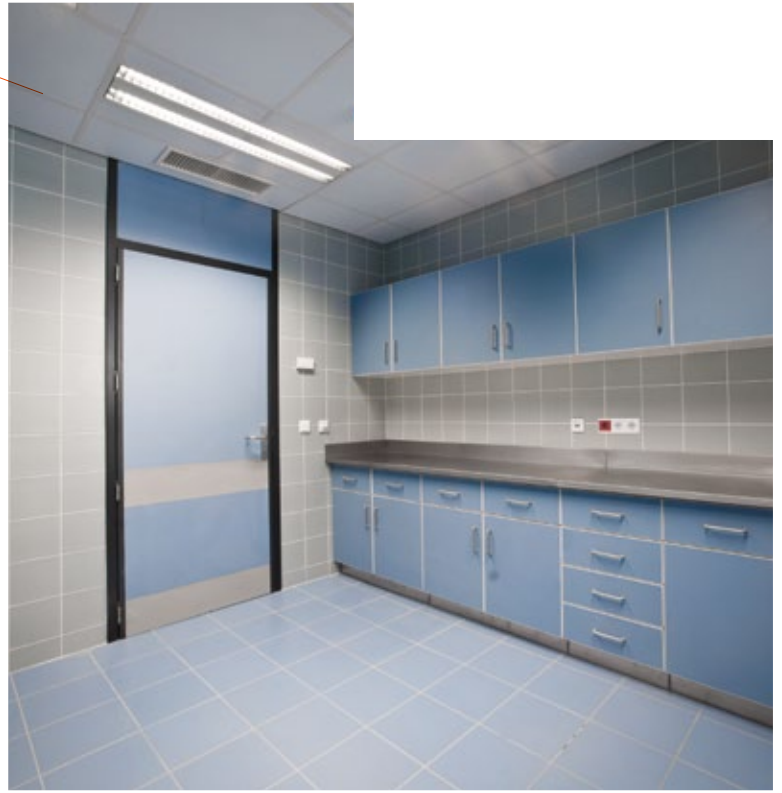

CCAS PARCÉ SUR SARTHE
CENTRE COMMUNAL D'ACTION SOCIALE - FRANCE
(Ad Hoc Architecture: B Migeon & JF Leroy)

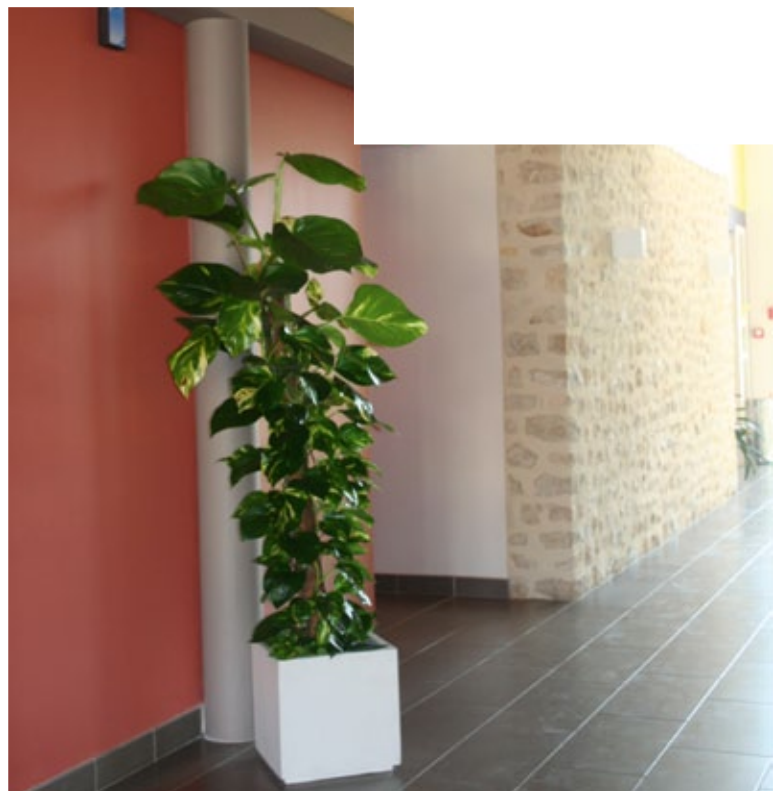

LA MAISON D'ACCUEIL DE LA SÉGUINIÈRE - FRANCE
MAISON DE RETRAITE
(Ad Hoc Architecture: B Migeon & JF Leroy)



UNI BEGE
UNI PERGAMON
UNI CHOCOLATE
UNI MOKA
UNI CRISTAL



Sta. C. MISERICÓRDIA TORRES VEDRAS - PORTUGAL



UNI ESTANHO
UNI PRATA
UNI GELO
UNI BAUNILHA
FINO TANGERINA R11



CENTRO SOCIAL S. JOÃO DA TALHA - PORTUGAL
(Arqª Isabel Ribeiro)

UNI GELO
UNI LIMA
GRANO LIMA
FINO MOKA

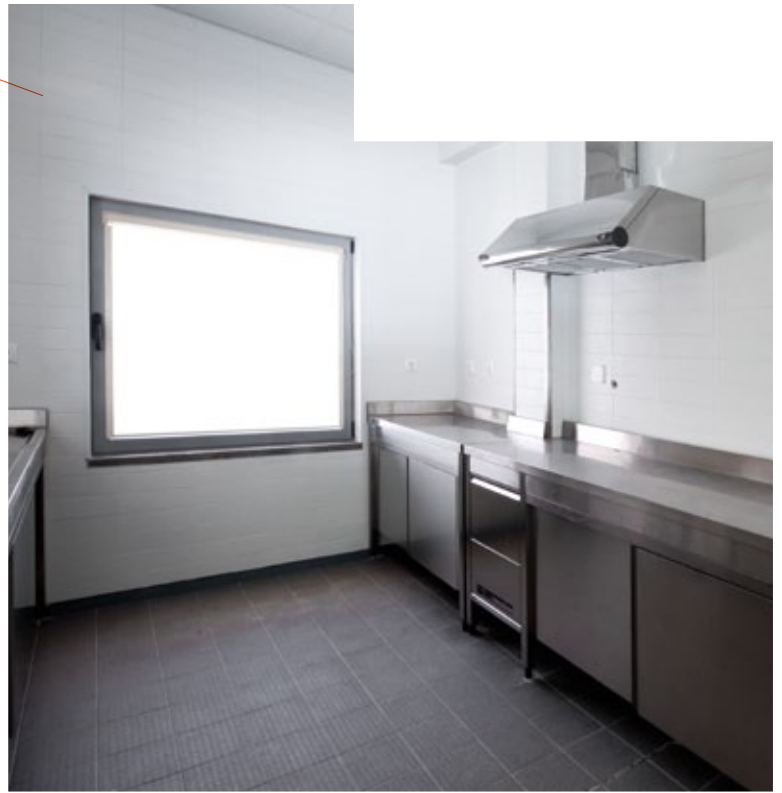

EHRETIA, LE GÂVRE - FRANCE
RÉSIDENTE DU MARTRAIS AU GÂVRE
(Ad Hoc Architecture: B Migeon & JF Leroy)

UNI MOKA
FINO MOKA
UNI MARRON
FINO MARRON



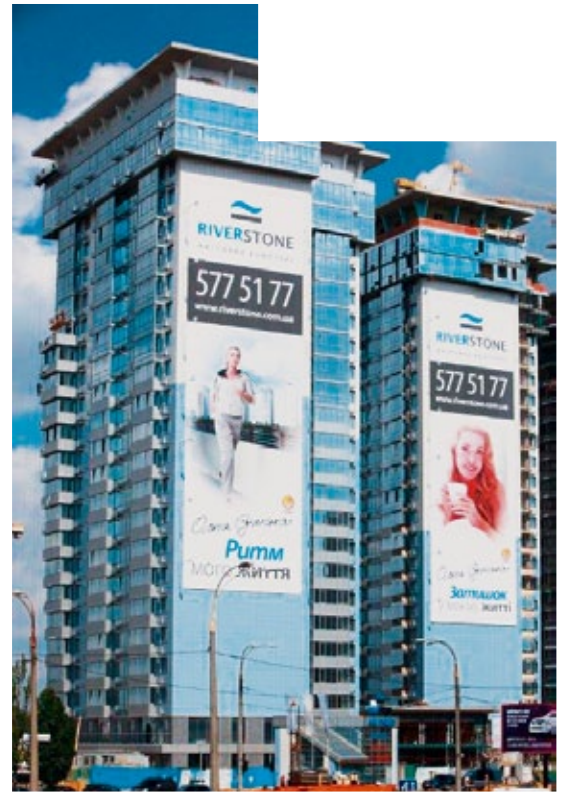

HEINDIJK ROTTERDAM - NETHERLANDS
(ARCHITECT: Math Architecten Delft)





CONDOMÍNIO DAS AREIAS - PORTUGAL
(EMPRIMONDI)

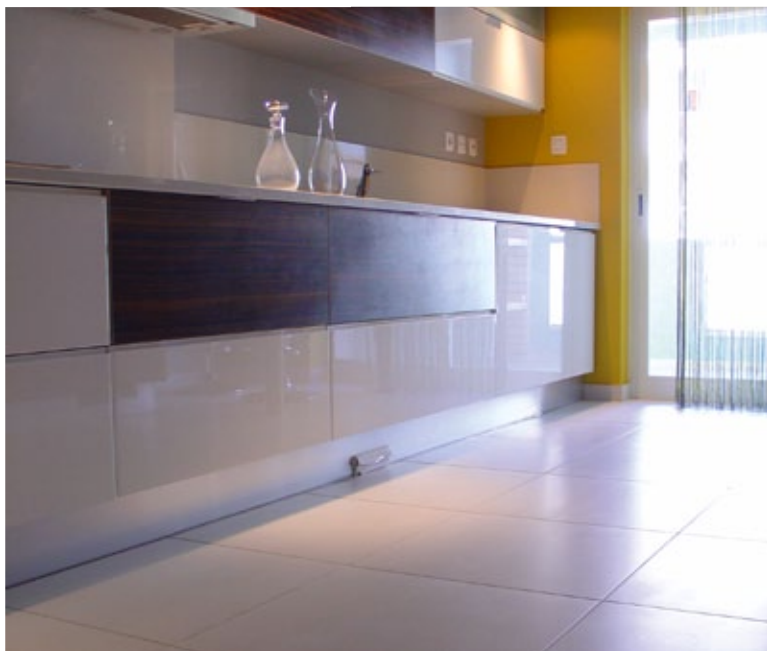

PRÉDIO DE HABITAÇÃO - PORTUGAL
CONSTRUTORA COSMOS
(Arqº Carlos Coelho)



NL PROJECT SCHIEDAM - NETHERLANDS



Portugal

Centro escolares e outras	Câmara de Gaia	
Escola Básica de Marmoiral	Arq. Luis Correia	
EB Laborim de Cima, Mafamude e outras	Arq. Botelho	
Pousada de Lisboa Small Luxury Hotels Of The World		várias cores
Escola EB Laborim de Cima E outras		
Escola Básica de Marmoiral		
Escola Básica de Megide (Jardim de Infância) - Canelas	Arq.ª Ana Vaz	
Escola Básica Igreja e Lavadores - Olival	Arq.ª Ana Vaz	
Escola Básica Urbano Santos Moura - Crestuma	Arq.ª Ana Vaz	
Jardim de Infância da Aguda - Arcozelo	Arq.ª Ana Vaz	
E. Leclerc		
Centro Comercial Alegro, Setúbal	Sua Kay Arquitectos	
ASAE		
Academia Militar da Amadora		
Fundação Tabor, IPSS Setúbal	Arq. Angelina Santos	
PT - Portugal Telecom	Arq Sílvia Cassiano	
Instituto de Cardiologia Preventiva de Almada	Aripa Atelier	
Hospital de Cascais	Aripa Atelier	
Estação Intermodal do Pinhal Novo	Arq. Mota Guedes	
EDP - lojas (stores)		Grano Cappuccino
Lojas do Cidadão		Uni Estanho
Shopping Sintra Jumbo		várias cores
Ikea - Braga e Alfragide		uni cristal e Fino Estanho
Lar de Idosos - Pinhal Novo		várias cores
Ar.Co - Centro de Arte e Comunicação Visual		uni carvão
Lojas Armani		97x297 várias cores
Lojas Adidas		97x297 várias cores
Teatro da Trindade, Lisboa	Arq. Pilar Santos	Uni anémoma, Uni estanho, Uni carvão, Uni lima, Grano Lima, Grano carvão

UK

Northwich Memorial Court	Ellis Williams Architects	Uni Turquesa
Aylesbury Leisure centre, S&P Architects		Uni Estanho
Claire's Accessories, Solus		Uni Gelo
Costcutter convenience stores		Fino Metal

France

AccorHotels Arena		
La Bibliothèque Alexis-de-Tocqueville	Rem Koolhaas	
Banque Postale	Chaix et Mavel	GELÓ ET NUVEM
EADS aux Mureaux	ENIA	MÉTAL ET CRISTAL
Immeuble bureau Montreuil	Cabinet Wilmottte	GELÓ
Crèche Dammartin en Goële	NOMADE	ESTANHO
Fondation Ste. Thérèse	ARCANE Concept	GELÓ
Immeuble bureau à Dammarie les Lys	Cabinet Kirchoff	GRANO MOKA+MOKA+PAPIRO
Lyceé de Montgeron	EPICURIA	ESTANHO+FINO ESTANHO
Fondation Mie de Pain	Robain - Guieysse	FINO BEGE
Ecole ENSEA	Dusapin et Leclercq	ESTANHO+FINO ESTANHO
Maison Retraite à Guinerville	Agence GACHET	MOKA+BAUNILHA
Lyceé Descartes à Antony	Atelier Catherine FURET	MOKA
Opéra Garnier à Paris	Cabinet Daguin-Bovies	GELÓ AD
Lyceé à Sèvres	AIA (Paris)	ESTANHO+FINO ESTANHO
Immeuble Bureaux à Orléans	AEC Ingénierie	MOKA+CHOCOLAT
Centre de Recherche DIGITEO	BRS Architecte	ESTANHO+MOKA+CHOCOLAT
Centre Universitaire Gros Mabillon	Cabinet MAUGER	BEGE+PAPOILA+PAPIRO AD
TOUR DESCARTES	HUBERT & ROY	20X20 AD ESTANHO
ECOLE VIEILLE EGLISE	ATELIER GROISY	FINO ESTANHO ET CRISTAL AU MUR
Lycée Gallieni Toulouse	Cabinet Vasconi	FINO CARVAO, UNI METAL
Hotel Radisson Toulouse	Cabinet Puig/pujol	UNI MOKA, UNI PERGAMON
Médiathèque de Lourdes	Cabinet Gil et Pereto	UNI LIMA, uni ANEMONA, uni GEMA , uni METAL, uni GELÓ, uni PAPOILA
AFPA de Balma	Cabinet PPA	UNI GELÓ, UNI CARVAO
Bureaux Gamba	Cabinet Vigneu et zillio	UNI MOKA
CFAI de Vauzelle	Cabinet Vigneu et Zillio	UNI MOKA, UNI LIMA, FINO MOKA
Hotel de region haute garonne	Cabinet Aleyrac	UNI GELÓ
MAPAD CAP FERRET	Cabinet Pethaud letang	UNI MOKA, UNI LIMA, UNI GEMA
Mapad Grand cèdre Bordeaux	Cabinet Delmas	UNI GELÓ, UNI PRATA, UNI MAR
Hopital de Libourne	TLR Architecture	UNI Crystal, uni lago, uni Lima
Bureaux Codic	Cabinet Aleyrac	UNI MOKA, UNI BEGE
College de Beaumont	Cabinet Griffoul	UNI ESTANHO, UNI PRATA
Hopital Albi	AIA	UNI METAL, UNI LIMA, uni LAGO, uni GELÓ
Chateau Laffite Rotschid	Atelier Mazières	UNI METAL
Médiathèque Mont de Marsan	Pétaud-Létang	UNI PRATA
Ecole des arts Carcassonne	Cabinet Aleyrac	UNI GELÓ, UNI CARVAO
Bibliothèque de Mazé	Atelier de la maison rouge	MÉTAL, ESTANHO
Centre Malakoff Nantes	Bohuon Bertic	MOKA, ESTANHO, CHOCOLAT
Construction d'une résidence pour personne désorientées de Landevant	Cabinet Dunet	CRISTAL, GEMA, LIMA, LAGO
EHPAD 92 lits ELVEN	Ad Quatio	CRISTAL, GEMA, LIMA, LAGO, MOKA, CARVAO
EPAD Challans	AD HOC ARCHITECTURE	MOKA,LIMA, GEMA, TANGERIA
FAM Challans	AD HOC ARCHITECTURE	MOKA,LIMA, GEMA, TANGERIA
Restructuration des consultations du pôle ostéo-articulaire à l'hôtel-Dieu Nantes	Parent Rachdi	LAGO, CEU, TANGERINA, MELOA, GELÓ, LIMA
Caserne Pompier de Guerande	DDL Lorient	PRATA, METAL, ESTANHO
Collège d'Heric	Cabinet Michau	MOKA, ESTANHO, CHOCOLAT
Lycee Jacques Cartier St Malo	Grignou Qumper	LAGO, CEU, TANGERINA, MELOA, GELÓ, LIMA, MOKA, ESTANHO, CHOCOLAT
Plate-forme Industrielle Courrier de Rennes	Alcimai	MULTICOULEUR, PAS DE DETAIL
SALLE MULTIFONCTION DE SAINT GILDAS DES BOIS	Vignault Faure	LAZULI, TANGERIA, SOL
SALLE POLYVALLENT DE BOUGUENAIS	DLW Nantes	PRATA, ESTANHO, METAL
Salle Sportive de Chateaubriant	Xavier Ménard Architecture et Urbanisme	MÉTAL, ESTANHO
Vallon des Dervalieres Nantes	Mauffret Guervilly (22)	MOKA, ESTANHO, CHOCOLAT
MFR Challans		Uni Gelo, Uni Tropical
Intermarché Castanet		
Collège St-Hilaire		

PROJECTOS . PROJECTS
 PROYECTOS . PROYECTOS . OBJEKTE

Singapore

Tiong Bahru Plaza		Uni Carvão, Uni Estanho, Uni Gelo
NUS Graduate Residence	AWP	UNI ESTANHO, UNI GELO
Joel Robuchon Restaurant @ Resort World Sentosa		UNI MOKA
Vivocity Shopping Centre	DP Architect	UNI GELO
Saint Anthony's Canossian Primary and Secondary School	RSP	ASSORTED COLOURS
Bugis MRT Downtown Line	Aedas	UNI CRISTAL, UNI LIMA, UNI PRATA, UNI TANGERINE
DBS MBFC T3		UNI GELO
Senoko 5 factory	HOB	UNI CRISTAL
W Hotel	Axis Planner	UNI GELO, UNI BAUNILHA
Volaris condominium	Architect 61	UNI GELO
Landmark MRT	Architect Ong & Ong	UNI ESTANHO, UNI GELO
NUS Create	Aedas	UNI ESTANHO, UNI GELO
Nex Shopping Centre		UNI MOKA, UNI CHOCOLATE, UNI GEMA, UNI PERGAMON
ITE	RSP	UNI BEGE, PRETO
Marina MRT		FINO MOKA
Punggol primary school		SEVERAL COLOURS
FusionPolis		
Solaire Casino Manila		
Singapore Institute of Technology		
Bukit Panjang MRT Station		
2 Downtown MRT Station		
Changi Hospital Children Ward		
National Technology University		
Indian Global School		
Cathay Pacific Lounge		
National Centre of Infectious Disease		

Qatar

Qatar		
Hamad Internacional Airport - New Doha Internacional Airport	Steering Committee	
Ministry of Interior Building	Ministry of Interior	
Al Shaqab Education City	Qatar Foundation	
Pumping Station (various)	Public Works Authority - Ashgal	
Car Showroom	Living Interiors	
Qatar University	Qbec - Qatar University	
Halul Island - Qatar Petroleum (centralized industrial area)	Qatar Petroleum	
Qatar Foundation - North Site Utility Tunnels	Qatar Foundation	
Truck Marshalling Area	Qatar Foundation	
Doha Mall	Al Seal Contracting	
Scouts Overland Camp - Qatar Scouts & Guides Association at Al Mazrouaa	Public Works Authority - Ashgal	
Scouts Headquarter Building - Qatar Scouts & Guides Association at Ain Khalid	Public Works Authority - Ashgal	
Qatar Hanball Stadium - Multi-purpose Sports Hall	Private Engineering Office	

Around the World

ADNOC Housing Buildings - Abu Dhabi		uni papiro, uni gelo, uni moka, uni baunilha, uni pergamon,
The Oberoi Beach Resort Al Zorah - Abu Dhabi		Uni gelo
Amman St. Regis Hotel & Residence - Jordanie		Uni Gelo